



**PowerMate™**  
**Portable**  
**Owner's**  
**Guide**

**NEC**



# PowerMate™ Portable Owner's Guide

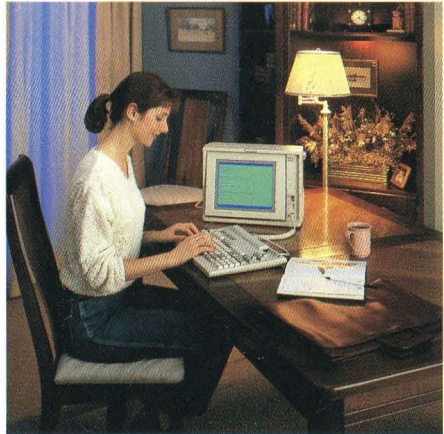

---

## LIABILITY DISCLAIMER

NEC Information Systems, Inc. (NECIS) products are warranted in accordance with the terms of the applicable NEC Information Systems, Inc. product specification. Product performance is affected by system configuration, software, the application, customer data, and operator control of the system, among other factors. While NECIS products are compatible with the standards for which they are advertised, implementation by customers of the product may vary.

Therefore, the suitability of a product for a specific application must be determined by the customer and is not warranted by NECIS.

This manual is as complete and factual as possible at the time of printing; however, the information in this manual may have been updated since that time. NEC Information Systems, Inc. reserves the right to change the functions, features, or specifications of its products at any time, without notice.

NEC Information Systems, Inc. has prepared this document for use by NECIS customers and employees. The information contained herein is the property of NECIS and shall not be reproduced without prior written approval from NECIS.

APC IV is a trademark of NEC Corporation.  
MS-DOS is a registered trademark of Microsoft Corporation.  
PowerMate is a trademark of NEC Corporation.  
Silentwriter is a trademark of NEC Corporation.  
Spinwriter and Pinwriter are registered trademarks of NEC Corporation.

First Printing - November 1987

Copyright 1987  
NEC Information Systems, Inc.  
1414 Massachusetts Ave.  
Boxborough, MA 01719

Printed in U.S.A.

---

## **FEDERAL COMMUNICATIONS COMMISSION RADIO FREQUENCY INTERFERENCE STATEMENT**

This unit has been type-tested and found to comply with the limits for a Class B computing device in accordance with the specifications for Subpart J of Part 15 of FCC Rules, which are designed to provide reasonable protection against such interference in a residential installation.

### *Manufacturer's Instructions and User's Responsibility to Prevent Radio Frequency Interference*

#### **Manufacturer's Instructions**

The user must observe the following precautions in installing and operating this device:

1. Operate the equipment in strict accordance with the manufacturer's instructions for the model.
2. Plug the unit into a properly grounded wall outlet and use the power cord supplied with the unit, unmodified.
3. Always operate the unit with the factory-installed cover on the unit.
4. Make no modification to the equipment which would affect its meeting the specified limits of the Rules.
5. Maintain the equipment in a satisfactory state of repair.
6. Use a shielded and properly grounded I/O cable to ensure compliance of this unit to the specified limits of the Rules.



---

## User's Responsibility

The user is ultimately responsible for correcting problems that arise from harmful radio-frequency emissions from equipment under his control. If this equipment does cause interference to radio or television reception (which can be determined by turning the equipment off and on), the user is encouraged to try to correct the interference by one of the following measures. All of these responsibilities and any others not mentioned are exclusively at the expense of the user.

1. Change in orientation of the receiving device antenna.
2. Change in orientation of the equipment.
3. Change in location of equipment.
4. Change in equipment power source.

If these attempts are unsuccessful, install one or all of the following devices:

1. Line isolation transformers
2. Line filters
3. Electro-magnetic shielding

If necessary, the user should consult the dealer, NEC, or an experienced radio/television technician for additional suggestions. The user may find the following booklet prepared by the Federal Communications Commission to be helpful: "How to Identify and Resolve Radio-TV Interference problems." This booklet is available from the U.S. Government Printing Office, Washington, D.C. 20402, Stock No. 004-000-00345-4.

### NOTE

The operator of a computing device may be required to stop operating his device upon finding that the device is causing harmful interference and it is in the public interest to stop operation until the interference problem has been corrected.

---

# Contents

---

	<b>Page</b>
System Components .....	2
Setting Up .....	4
Connecting Peripheral Options .....	11
Features and Controls	
Monochrome Display .....	15
System Unit .....	16
Keyboard .....	19
Your First Program .....	21
Microdiskettes and Microdiskette Care .....	23
Inserting and Removing a Microdiskette .....	24
Write Protection .....	25
Precautions .....	26
Moving Your Computer .....	27
PowerMate Portable Care .....	29
Options .....	30
Display .....	30
Keyboard .....	30
Boards and Chips .....	31
Drives .....	32
Accessories .....	33
NEC Printers for the PowerMate Portable .....	34
If You Have a Problem .....	35
System Board Switch Settings .....	38
Checking Switch Settings .....	39
Specifications .....	47
Glossary .....	51
Index .....	55



---

# Tables

---

	<b>Page</b>
Solving Problems .....	36
Diskette Drive Designation .....	41
Switch Settings for AGB as Primary Controller Board .....	43
Switch Settings for AGB as Secondary Controller Board .....	43
Colors Displayed When Switch 2-4 is On .....	45
Colors Displayed When Switch 2-4 is Off .....	45

The NEC APC IV™ PowerMate™ Portable is an advanced high-performance, transportable, personal computer (PC). It offers full functionality based on an 80286 microprocessor. In addition, the PowerMate Portable includes an adjustable monochrome liquid crystal display (LCD), a 93-key detachable keyboard, and 640 kilobytes (KB) of standard memory.

Its light weight and compact size make it perfect for travel and easy to store. The PowerMate Portable continues the NEC tradition of quality and reliability.





---

# System Components

---

The APC IV PowerMate Portable has three models. Each has the same three basic components.

SYSTEM UNIT

MONOCHROME DISPLAY

KEYBOARD

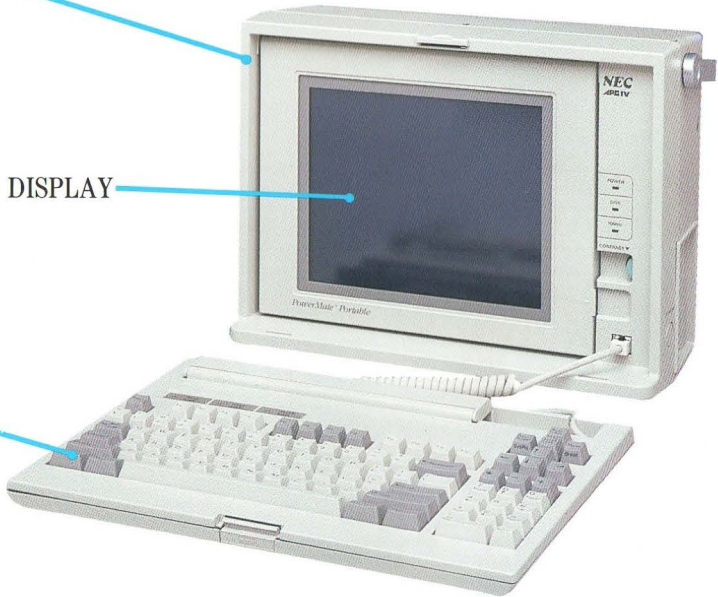

---

The three models differ in the type of magnetic storage devices in the system unit.

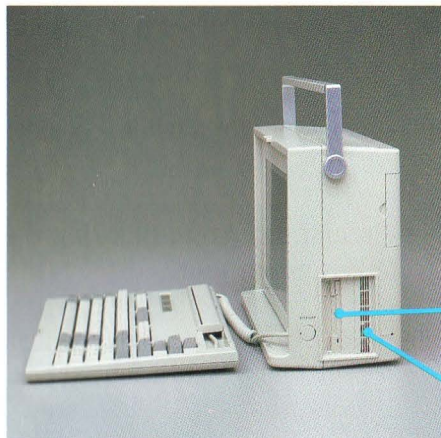

The APC-H700 has a single 3½-inch, 720-KB diskette drive.

The APC-H701 has a single 3½-inch, 720-KB diskette drive and a 20-megabyte (MB) hard disk.

720-KB DISKETTE DRIVE

20-MB HARD DISK

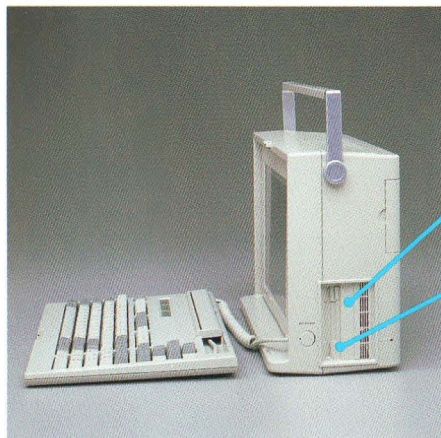

The APC-H702 has a single 3½-inch, 720-KB diskette drive and a 40-MB hard disk.

40-MB HARD DISK

720-KB DISKETTE DRIVE

You can add options such as a printer, external diskette drive, or additional memory to your PowerMate Portable. Refer to "Options."



---

# Setting Up

---

Setting up your PowerMate Portable consists of connecting the keyboard to the system unit, positioning the keyboard and display, and installing the power cord. It's simple to do. And all NEC options come with easy-to-follow installation instructions.

If you plan to keep the PowerMate Portable in one spot for a while, consider these suggestions.

- Set up where there is plenty of circulation. Avoid blocking the ventilation holes on the back of the system unit.
- Keep the PowerMate Portable away from excessively warm surroundings, direct sunlight, excessive dust, vibration, shock, or moisture.
- Be sure to keep the PowerMate Portable away from any devices, such as electric motors or transformers, that generate magnetic fields.

---

Then complete these steps for setting up.

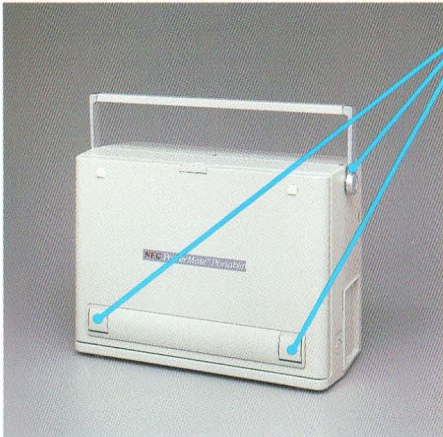

1 With the handle up, and the comfort supports facing you, place the PowerMate Portable on a flat, sturdy surface.

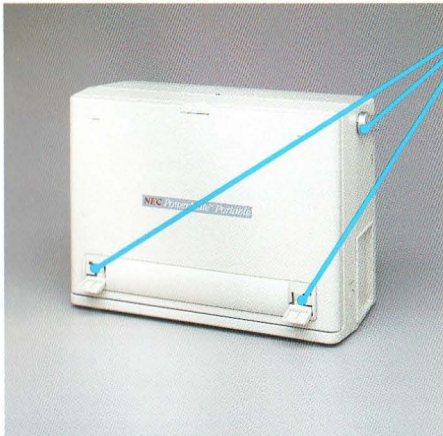

2 Lower the handle and comfort supports, if desired.



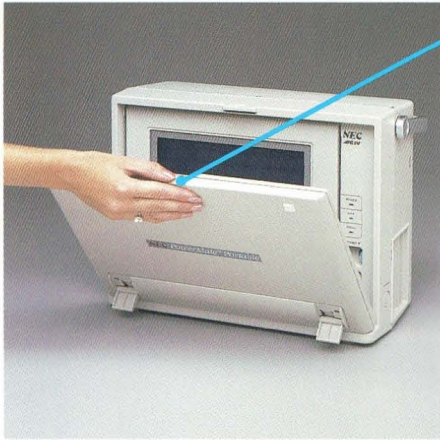

- 3 Press PUSH to release the detachable keyboard. Gently lower the keyboard away from the computer and onto the work surface.

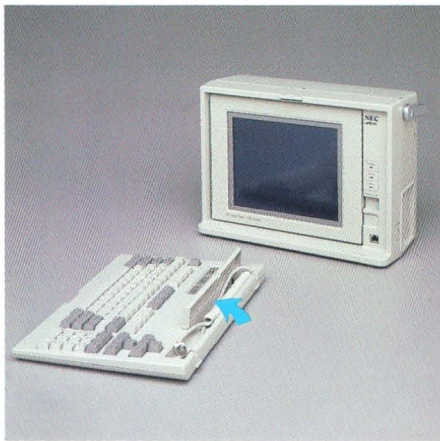

- 4 Press the tab on the cable storage tray cover. Swing the cover forward.



5 Lift the cord out of the tray and insert the connector, tab side up, into the keyboard port next to the display. The connector is fully inserted when you hear it “click” into position.

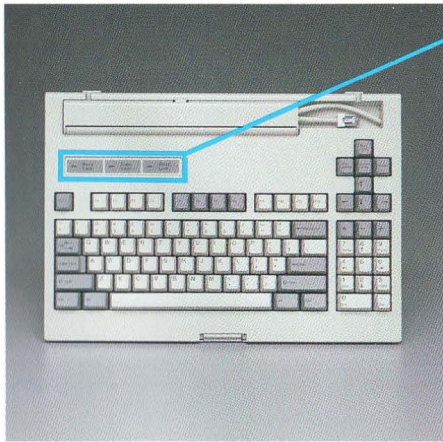

6 If your keyboard has a protective adhesive strip covering the status lamps, remove it.

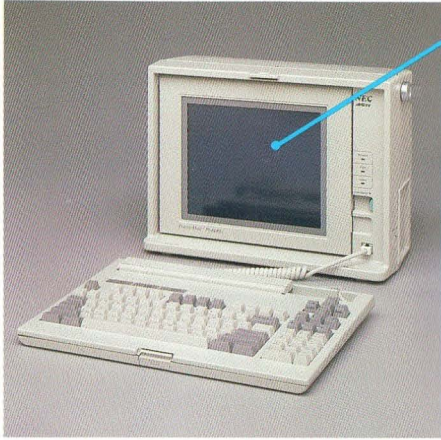

7 If the display screen is covered by a protective piece of plastic film, remove it.

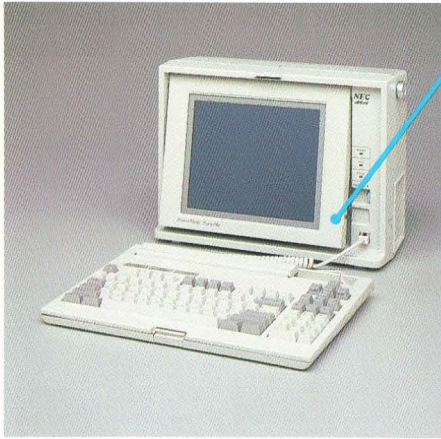

8 You can leave the display in its locked position or press PUSH to release and adjust it for more comfortable viewing.

**CAUTION** Be careful not to force the display past its 35° limit of adjustment. When you feel resistance, you've reached the maximum angle position.



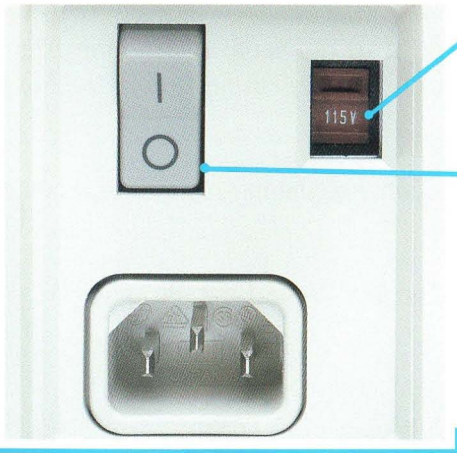

- 9 Check that the 115/230-V power supply switch is set correctly. The correct setting for the United States and Canada is **115 V**.
- 10 Be sure that the power switch is in the **0** (off) position.

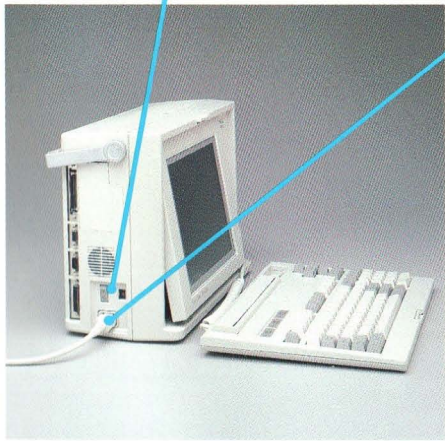

- 11 Plug the power cord into the system unit.



- 12 Plug the other end of the power cord into a properly grounded outlet.

**NOTE** The PowerMate Portable comes with an approved, three-pronged safety cord. To ensure your safety, do not alter the cord.

---

If you have peripheral options such as a printer, modem, or diskette drive to install, set them up now. Be sure to read the setup instructions that come with the options. Follow the steps for proper connection in the next section.

For information on option board installation, see the instructions that come with the board.

After setting up any desired options, go to “Your First Program.”

---

# Connecting Peripheral Options

---

The PowerMate Portable has five ports for connecting peripheral options.

Four ports are on the left side of the system unit.

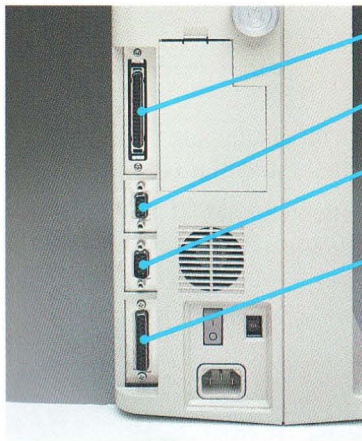

FDD (5¼-INCH DISKETTE DRIVE)

RGB (ADVANCED COLOR DISPLAY)

COM (SERIAL PRINTER, MODEM, OR OTHER RS-232C DEVICE)

PRINTER (PARALLEL PRINTER)

One port is on the right side of the system unit.

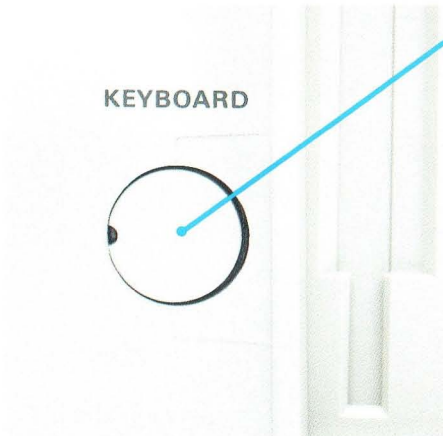

KEYBOARD  
(ENHANCED KEYBOARD)



---

Follow these steps for safe and correct peripheral option attachment.

**NOTE** Be sure that you have set up your option correctly before connecting it to the PowerMate Portable. Follow the setup instructions that come with the option.



- 1 Turn off and unplug the PowerMate Portable and the option.
- 2 To attach an APC-H410E Enhanced Keyboard, first disconnect the 93-key keyboard.

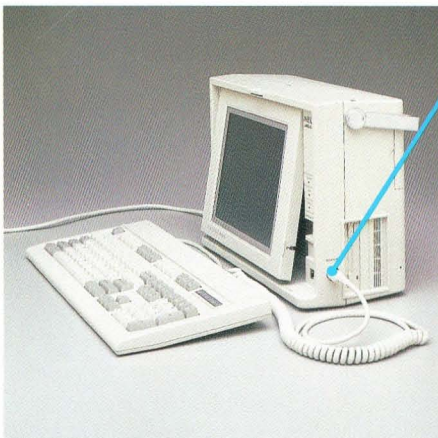

- 3 Then remove the connector cover with your fingers and plug in the Enhanced Keyboard.

Set the connector cover aside and be sure to reinsert it whenever you disconnect the Enhanced Keyboard.

To attach any other peripheral option go to step 4.

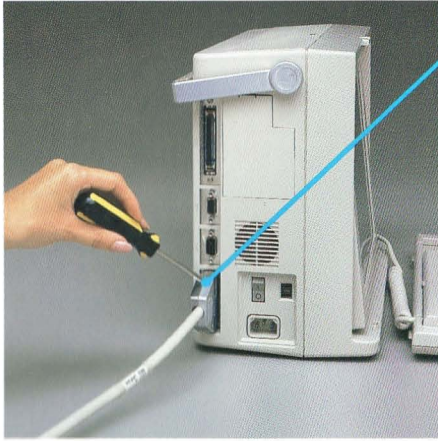

- 4 Remove the plastic connector cap and connect the option cable to the correct port on the PowerMate Portable. If cable screws are provided, use them to secure the cable connection. A printer cable is shown here as an example.

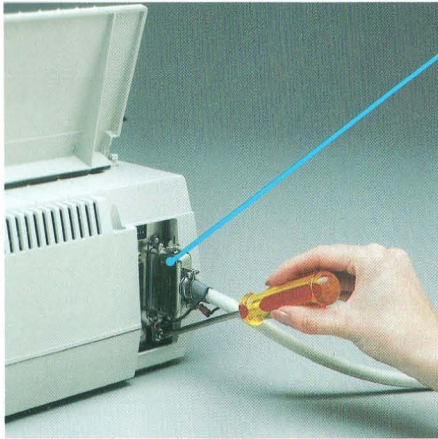

- 5 Connect the option cable to the option. If screws or connector clips are provided, use them to lock in the cable connection.
- 6 Plug in the PowerMate Portable power cord.
- 7 If the option has a separate power cord, plug one end into the option and the other into a properly grounded outlet.





# Features and Controls

## MONOCHROME DISPLAY

The PowerMate Portable features a high-resolution, blue backlit, display.

**NOTE** The 8- or 10-MHz clock speed can be changed by keyboard input. To switch the clock speed, hold down the **Ctrl** and **Alt** keys and press the -(minus) key on the numeric keypad. Clock speed is also software selectable.

**POWER LAMP (Green)**  
Indicates power on.

**DISK BUSY LAMP (Red)**  
Indicates when the hard disk is performing a read or write operation.

**10-MHz LAMP**  
Indicates when the system is operating at 10 MHz.

**CONTRAST DIAL**  
Turn to adjust the display brightness.

**DISPLAY RELEASE**  
Push to unlock the display for positioning.

**KEYBOARD CONNECTOR**  
Connector for the 93-key keyboard.

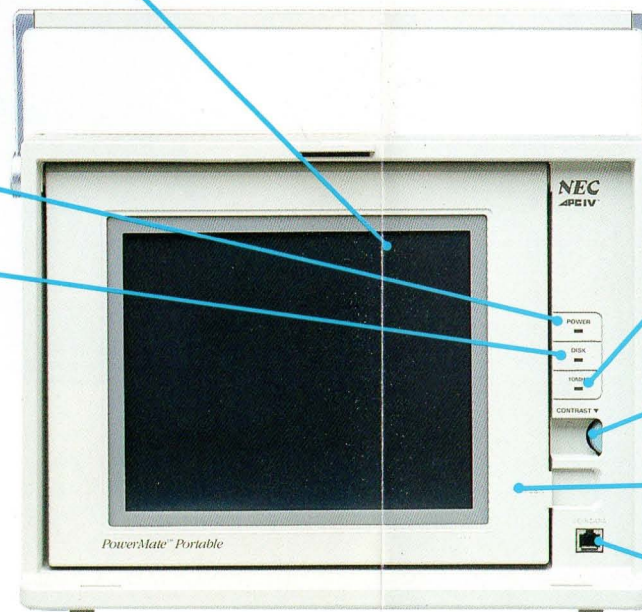

---

## SYSTEM UNIT

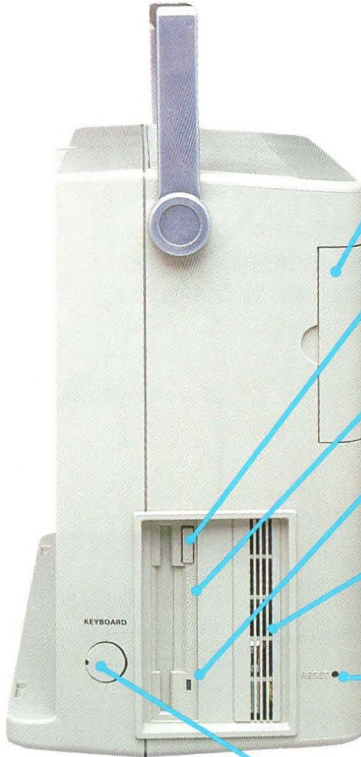

### SWITCH COVER

See "System Board Switch Settings."

### DISKETTE RELEASE BUTTON

Press to release a diskette from the drive.

### DISKETTE DRIVE

3½-inch 720-KB diskette drive.

### DISKETTE DRIVE BUSY LAMP

Indicates when a drive is reading or writing to a diskette.

### HARD DISK DRIVE

20-MB hard disk in model APC-H701 or 40-MB hard disk in model APC-H702.

### RESET BUTTON

Insert the point of a pen and press to perform a "cold boot," erasing any programs in the system memory.

### KEYBOARD CONNECTOR

Connector for an optional enhanced 101-key keyboard.

---

### OPTION SLOT COVER

Remove this cover when an optional APC-H750 Internal Modem Board is installed in option slot 3.

FDD (optional 5¼-inch diskette drive connector)

RGB (optional advanced color display connector)

COM (optional RS-232C connector)

PRINTER (optional parallel printer connector)

POWER SWITCH  
Press **1** to turn on power.  
Press **0** to turn off power.

115/230 V POWER SUPPLY SWITCH  
Selectable 115-V or 230-V power supply.

AC INPUT

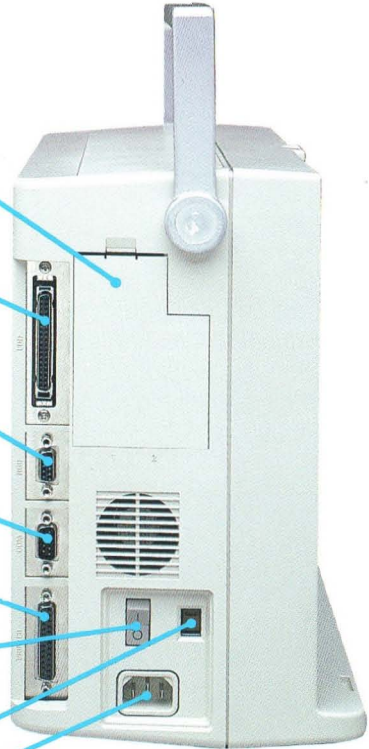



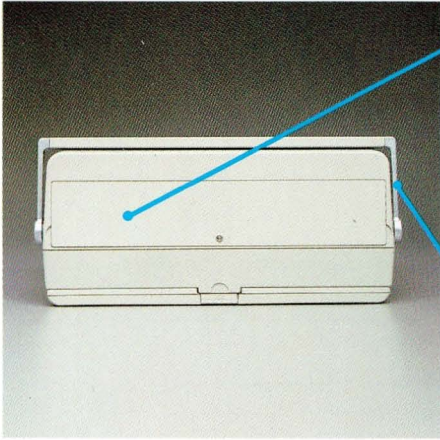

#### TOP OPTION SLOT COVER

Covers option slots 1, 2, and 3. Slots 1 and 2 are available for up to two optional APC-H450 512-KB Memory Boards or other option boards. Slot 3 is a dedicated slot for the optional APC-H750 Internal Modem Board. Remove this cover for board installation.

#### MOVABLE HANDLE

Use this handle to carry the PowerMate Portable from one place to another. It swings down easily for compact PC storage.

## KEYBOARD

The PowerMate Portable features a detachable, 93-key keyboard. Often keyboard usage depends upon your software applications program. For specific information, see the guide that comes with your software. General keyboard usage is described below.

**NOTE** Most of the keys have a repeat function. When you hold down a key, the character or function repeats itself until you release the key.

**CABLE STORAGE TRAY**  
Protects the keyboard cable when the PC is in transit.

**SLIDE SWITCH**  
(under cable storage tray cover)  
*Face the keyboard* and slide this switch to the right when you swap the original position of the Ctrl and Caps Lock keys.

**STATUS LAMPS**  
Indicate the status of the Caps (Capital) Lock, Num (Numeric) Lock, and the Scroll Lock keys.

**CTRL and CAPS LOCK**  
Key caps are interchangeable for specific software application program needs.

**NOTE** When you swap the original position of the Ctrl and Caps Lock keys, *face the keyboard* and move the slide switch, located inside the cable storage tray, to the right.

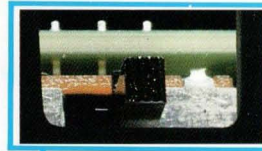

**CABLE CHANNEL**  
Routes the cable to prevent tangling.

**CURSOR CONTROL KEYS**  
Use these keys for controlling the direction of the cursor. These keys also function when the keypad is operative (Num Lock lamp is lit).

**NUMERIC KEYPAD/CURSOR CONTROL KEYS**  
Use these keys like a numeric keypad. In the numeric keypad mode (Num Lock lamp on), the Shift keys work in reverse.

To use these keys to control the direction of the cursor, press the Num Lock key (Num Lock lamp goes off).

To return to numeric keypad mode, press the Num Lock key.

**KEYS**  
Use these keys like typewriter keys.

**FUNCTION KEYS**  
Use these keys for functions specific to your particular software.

**COMFORT SUPPORTS**  
Open these hinged supports to adjust the angle of the keyboard to suit your needs.







---

# Your First Program

---

After setting up the PowerMate Portable, you must prepare the system for use. The MS-DOS™ System Diskette that is supplied contains the necessary software to boot-up and ready the system. Follow these steps to get started.

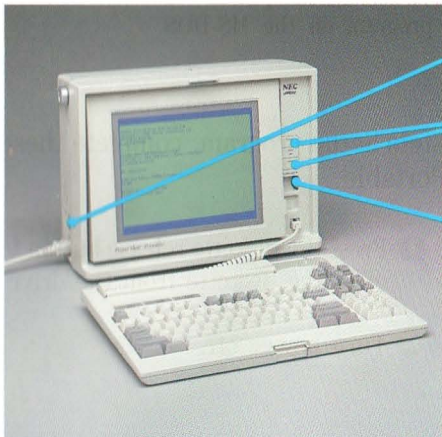

- 1 Turn on power.

The **POWER** lamp and the 10-MHz lamp light.

The power on screen appears.

- 2 Adjust the contrast dial to achieve the desired screen brightness.

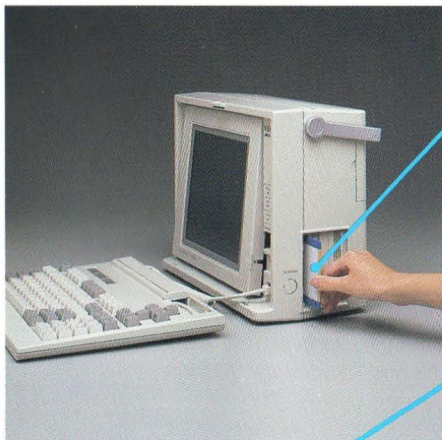

- 3 Insert the MS-DOS System Diskette, label side facing left, into the diskette drive.

Be sure to insert the diskette into the drive fully. The diskette release button pops out when the diskette is fully inserted.

- 4 Press **F1** to load the program into memory. The busy lamp on the front of the drive will light.

The drive makes a clicking sound while the program loads. Program loading takes about 10 seconds. One or two beeps indicate that the program is loaded.



The program's Entry menu appears, indicating the completion of the booting routine.



---

If anything does not work as described, see “If You Have a Problem.” After boot-up, go to your *MS-DOS for the APC IV Series Guide* for instructions on how to run the program.

**NOTE** Whenever you install or remove an option, you must run the System Setup program on the MS-DOS System Diskette.

When you are finished running the System Setup program, complete these steps to shut down the PowerMate Portable.

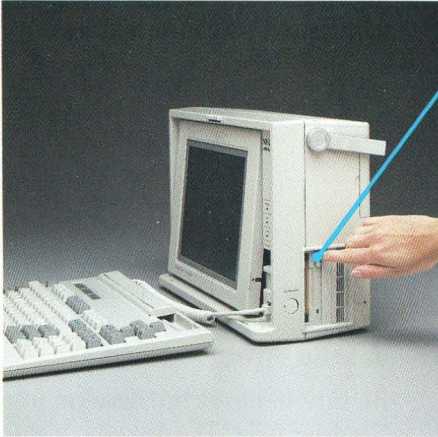

- 1 Press the diskette release button to eject the diskette from the drive.
- 2 Turn power off.

**CAUTION** To avoid diskette damage, never remove a diskette from the drive when the busy lamp is on. Always remove the diskette before turning power off.

---

# Microdiskettes and Microdiskette Care

---

The PowerMate Portable uses NEC 3½-inch double-sided microdiskettes.

Each microdiskette is housed in a hard plastic jacket. The diskette surface is protected from fingerprints and dust by an automatic shutter. When the diskette is ejected from the drive, the shutter slides over the exposed read/write area of the diskette.

Each double-sided microdiskette stores up to 720 KB, equivalent to about 360 pages of text. You must format blank diskettes to prepare them to store information. Refer to the *MS-DOS for the APC IV Series Guide* for formatting instructions.

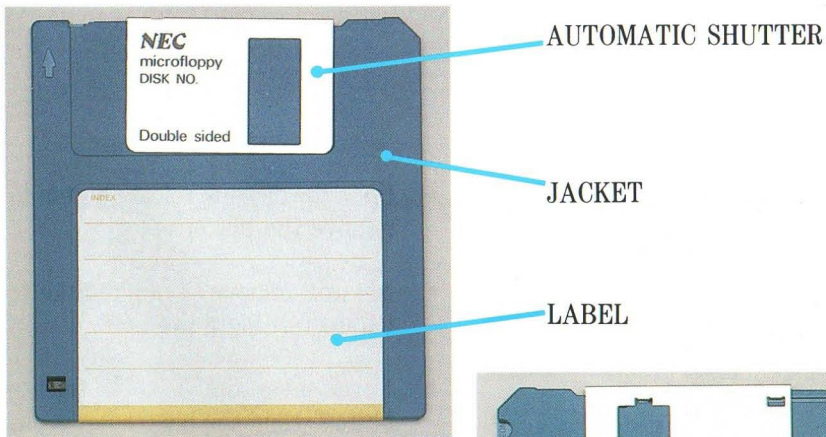

Front of Microdiskette

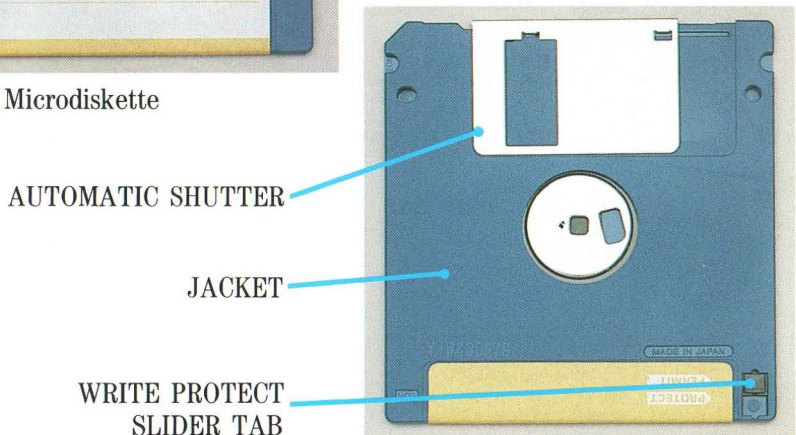

Back of Microdiskette

---

## INSERTING AND REMOVING A MICRODISKETTE

To correctly insert and remove a microdiskette, follow these guidelines.

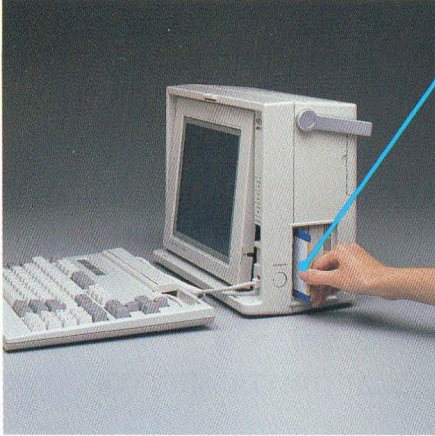

- Hold the microdiskette and insert it, label side facing left, into the drive.
- Be sure to insert the microdiskette into the drive fully. The diskette release button pops out when the microdiskette is fully inserted.
- Never insert a microdiskette before turning on power, even if your software instructions say to do so.

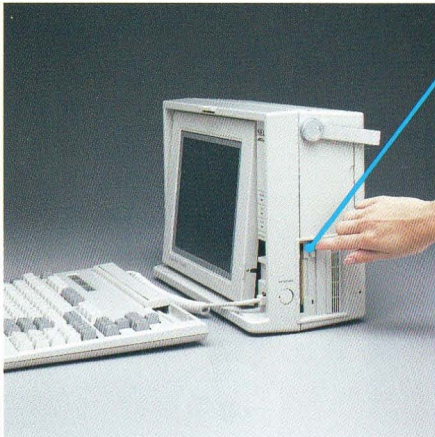

- Press the diskette release button to remove the diskette.
- Always remove a microdiskette before turning power off.
- Never press the diskette release button when the busy lamp is on.



---

## WRITE PROTECTION

You can write protect your microdiskette to ensure that you do not accidentally overwrite information.

When a diskette is write protected, you cannot store (write) information on it until you remove the write protection.



To write protect a 3½-inch microdiskette, slide the write protect tab to uncover the square hole.

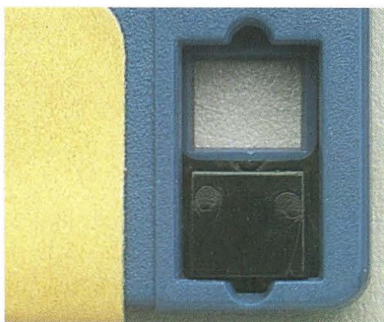

Write Protected

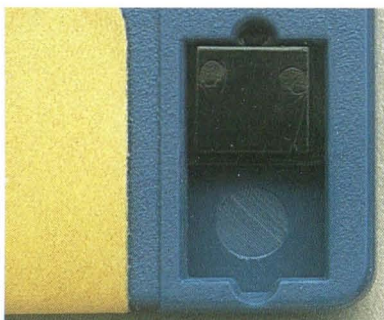

Write Enabled



---

## PRECAUTIONS

For reliability and protection from data loss, take the following precautions with your microdiskettes.



- Never bend or place heavy objects on a microdiskette. This could damage the hard plastic jacket.

- Do not pull back the shutter of a microdiskette to expose the magnetic disk.

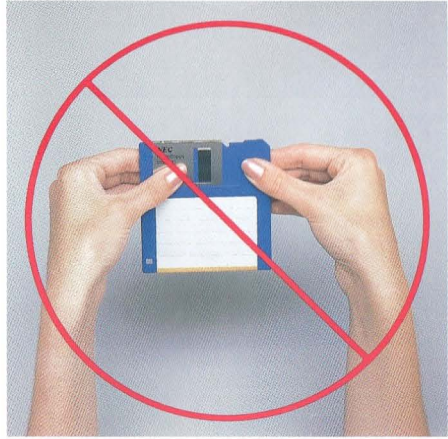

- Keep microdiskettes away from magnets or equipment that generates magnetic fields such as telephones, calculators, and dictation equipment.

---

# Moving Your Computer

---

Light weight and compact size make it easy to move your PowerMate Portable. Follow these simple steps when preparing to move your computer from one location to another.

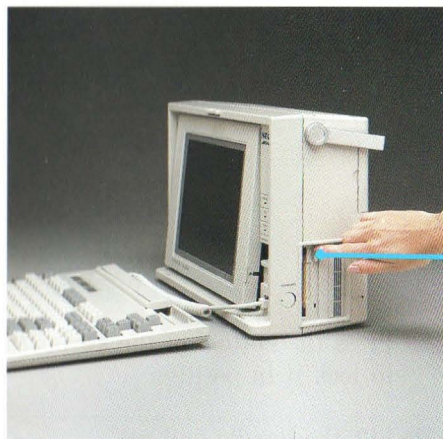

- 1 Be sure to save your files before turning power off. When power is turned off, data in random access memory (RAM) is lost.

Each application program has its own instructions for saving files.

- 2 Press the diskette release button to eject the microdiskette.
- 3 At the A> prompt, key-in **RETRACT** and press **ENTER** to retract the heads of the hard disk.

- 4 Turn power off.

- 5 Unplug the power cord from the outlet and from the unit.

Store the power cord in a safe place.

- 6 Disconnect and store any peripheral options.

- 7 Disconnect the keyboard and store the cable in the cable storage tray.

- 8 Push in the display to lock it in position.

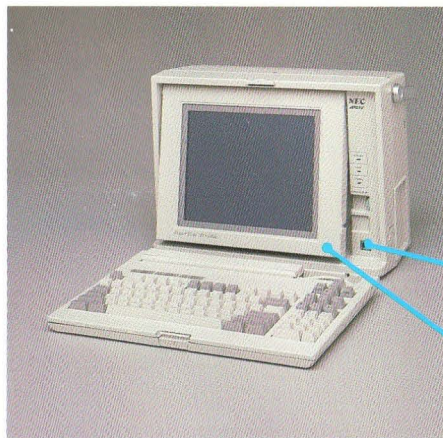

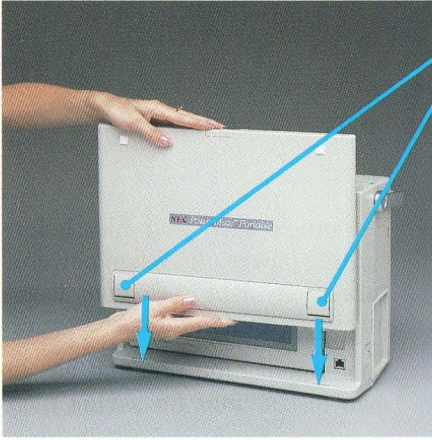

- 9 Lift the keyboard and fold the comfort supports inward. Lower the tabs into the holes in front of the display.

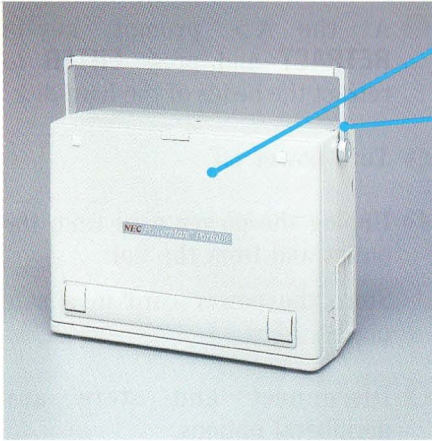

- 10 Press the bottom of the keyboard to lock it in position.
- 11 Lift the handle and go!



---

# PowerMate Portable Care

---



For safety always unplug the PowerMate Portable before cleaning it. Periodically clean the outside of the unit with a soft cloth. Remove stubborn stains with a cloth slightly dampened with a mild detergent. Never use strong cleaners or solvents on any part of the PowerMate Portable.



---

# Options

---

The following paragraphs describe NEC options for the PowerMate Portable. Installation instructions come with each option.

## DISPLAY

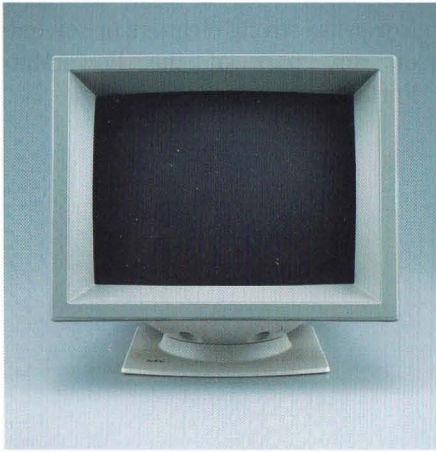

Advanced Color Display

### **Advanced Color Display APC-H431**

The Advanced Color Display automatically adjusts to display board frequencies from 15.75 KHz to 35 KHz for compatibility with many color graphics boards.

This high-resolution display can be used with the PowerMate Portable as well as systems containing the APC-H444 Advanced Graphics Board Plus, the APC-H440 Color Graphics Board, or the APC-H441 Advanced Graphics Board.

## KEYBOARD



Enhanced Keyboard

### **Enhanced Keyboard APC-H410E**

This industry-standard, enhanced 101-key keyboard is compatible with the PowerMate Portable, all other models in the APC IV series of personal computers, and the PowerMate 386.

---

## BOARDS AND CHIPS

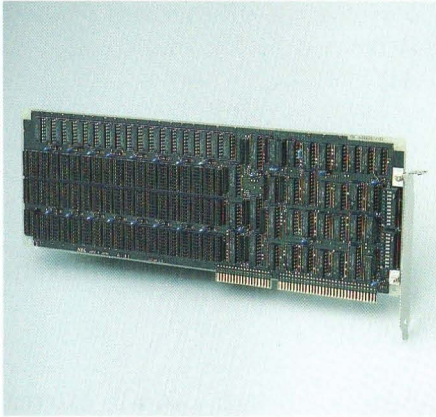

512-KB 16-Bit Memory  
Expansion Board

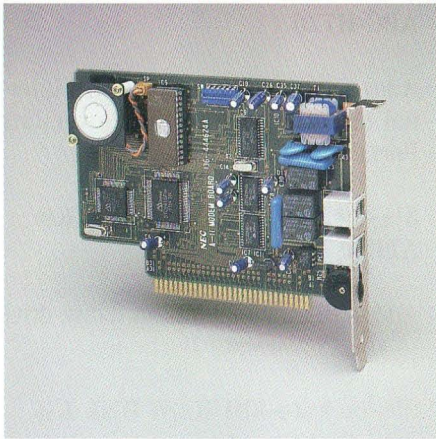

Internal Modem Board

### **512-KB 16-Bit Memory Expansion Board APC-H450**

Increases the system memory by 512 KB and has sockets on the board for installing up to three APC-H451 Memory Expansion Kits. The board has a total memory capacity of 2 MB. Up to two memory boards can be installed in the PowerMate Portable.

### **512-KB Memory Expansion Kit APC-H451**

This 18-chip kit adds 512 KB to the APC-H450 Memory Expansion Board.

### **80287 Math Coprocessor APC-H552**

Adds an additional microprocessor, thus increasing the PowerMate Portable's processing speed for "number crunching" applications such as complex scientific and mathematical tasks.

### **Internal Modem Board APC-H750**

This intelligent modem board permits full-duplex transmission at 300/1200 bits per second (bps) via a dedicated slot in the PowerMate Portable.

---

## DRIVES

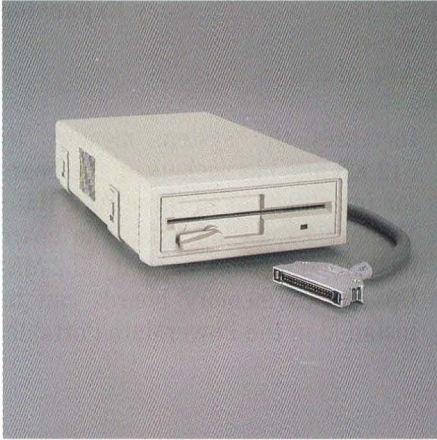

### **5¼-inch 1.2-MB External Diskette Drive APC-H723**

Adds a 5¼-inch 1.2-MB external diskette drive to the PowerMate Portable.

### **5¼-inch 360-KB External Diskette Drive APC-H724**

Adds a 5¼-inch 360-KB external diskette drive to the PowerMate Portable.

### **3½-inch 720-KB Diskette Drive Kit APC-H720**

Adds a second 3½-inch 720-KB internal diskette drive to the PowerMate Portable.

### **3½-inch 20-MB Hard Disk Kit APC-H721**

Adds a 3½-inch 20-MB hard disk drive to the PowerMate Portable.

### **3½-inch 40-MB Hard Disk Kit APC-H722**

Adds a 3½-inch 40-MB hard disk drive to the PowerMate Portable.



---

## ACCESSORIES

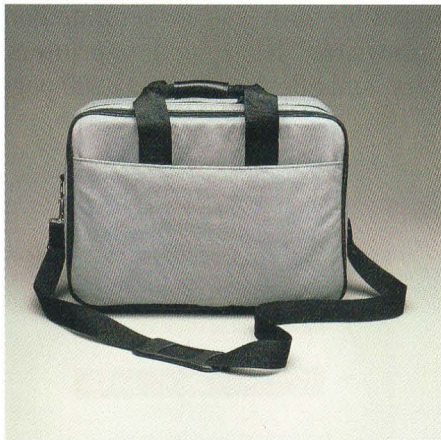

**Carrying Case  
APC-H760**

This carrying case is designed specifically for transporting the PowerMate Portable comfortably.



**Printer Cable  
APC-H490**

**RS-232C Cable  
APC-H491**

Printer Cable



---

## NEC PRINTERS FOR THE POWERMATE PORTABLE

NEC makes several printers that are compatible with your PowerMate Portable. These include the following Spinwriter® letter-quality printers, Pinwriter™ multimode dot matrix printers, and Silentwriter™ LC-800 page printers.

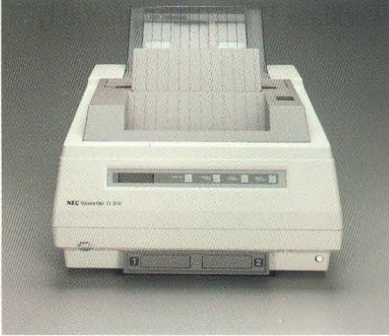

Silentwriter LC-800



3550 Spinwriter



8850 Spinwriter



Pinwriter P6



Pinwriter P7



Pinwriter P9XL

---

# If You Have a Problem

---

The PowerMate Portable has a built-in checking program that automatically tests its components when you turn on power. If there is a problem in the system, intermittent beeping occurs. If this happens repeatedly when you turn on power, turn power off and call your NEC dealer.

If you encounter a problem with the PowerMate Portable and beeping does not occur, the problem is usually a simple one that you can solve yourself. First check the items in the following checklist.

- The power switch is on.
- All cables and power cords are tightly connected.
- The power cord is plugged into a working outlet. Test the outlet by plugging in a lamp or other electrical device.
- The 115/230-V power supply switch is set correctly.
- The display contrast dial is adjusted properly.
- Any option that you have installed is designed for the PowerMate Portable and is set up correctly.

If these items do not help, see the following “Solving Problems” table. If you still can’t determine the problem, call your PowerMate Portable dealer.

---

## SOLVING PROBLEMS

Problems and Symptoms	Corrective Actions
<p><b>A diskette won't load.</b></p> <ul style="list-style-type: none"><li>• POWER lamp is on.</li><li>• Diskette drive busy lamp doesn't come on when you insert the diskette.</li><li>• Power-on screen appears on the display.</li></ul>	<p>Check that the diskette is inserted correctly.</p> <p>If so, try a different diskette. If this loads, the problem is in your software. Call your software dealer.</p> <p>If this won't load, call your PowerMate Portable dealer.</p>
<p><b>The screen stays dark.</b></p> <ul style="list-style-type: none"><li>• POWER lamp is on.</li><li>• All cable connections are tight.</li><li>• The display contrast dial is adjusted correctly.</li></ul>	<p>Call your hardware dealer.</p>
<p><b>The display's power-on self-test remains on the screen.</b></p>	<p>Press F1. If the power-on screen is still displayed, load a different diskette. Press F1. If the diskette loads, you have a software problem. Call your software dealer.</p> <p>If the power-on screen is still displayed, call your PowerMate Portable dealer.</p>
<p><b>A distorted image appears on the display screen.</b></p>	<p>Adjust the display contrast dial. If that doesn't help, turn the unit off for a few seconds and then turn it back on. If the problem persists, call your hardware dealer.</p>



---

## SOLVING PROBLEMS (CONT'D)

Problems and Symptoms	Corrective Actions
<b>Keyboard seems “dead.”</b>	Be sure that the keyboard connection is tight. If so, call your PowerMate Portable dealer.
<b>Graphics characters or “garbage” appear on the screen when you use the keyboard.</b>	Run a different program. If this runs properly, you have a software problem. If it doesn't, call your PowerMate Portable dealer.
<b>Constant screen movement.</b>	Magnetic field is affecting your display. If you have another display close by, or other device with a motor generating a magnetic field (for example, a fan), move the display or device away from the affected display.

---

# System Board Switch Settings

---

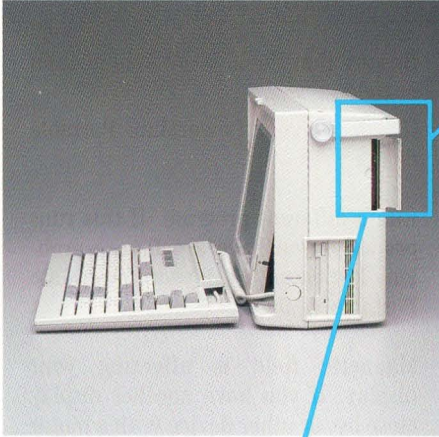

These are the factory switch settings for the PowerMate Portable. The switches are located under the switch cover on the outside of the system unit.

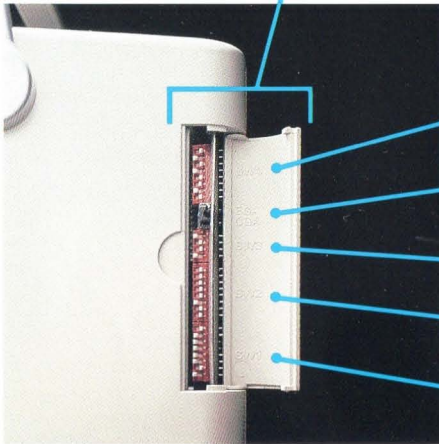

SW4

EGA  
CGA

SW3

SW2

SW1

---

## CHECKING SWITCH SETTINGS

The following pages describe the switch setting functions.

If you need to change any settings for your particular application, follow these guidelines.

**WARNING** Always turn power off before changing any switch setting.

- To change the toggle switch setting, simply flip the switch up or down.
- Use a pointed instrument such as the tip of a ballpoint pen to change any of the other settings. The ON setting is to the right. The OFF setting is to the left.





Switch 4

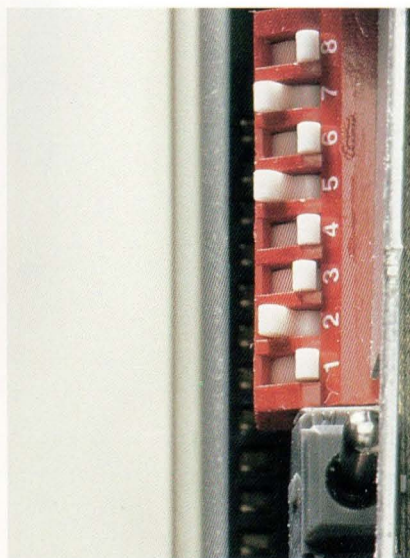

SW4-8  
SW4-7  
SW4-6  
SW4-5  
SW4-4  
SW4-3  
SW4-2  
SW4-1

TOGGLE SWITCH

DISKETTE DRIVE DESIGNATION

SW4-1	SW4-2	Diskette Drive Designation
On	On	Drive A — First internal Drive B — Second internal
Off	On	Drive B — First internal Drive A — Second internal
On	Off	Drive A — First internal Drive B — External (5¼-inch)
Off	Off	Drive B — First internal Drive A — External (5¼-inch)

DISPLAY TYPE  
SW4-8  
ON: Color display  
OFF: Monochrome display

DISKETTE DRIVE CONTROLLER I/O ADDRESS  
SW4-7  
ON: Second (370 hex — 377 hex) valid  
OFF: First (3F0 hex — 3F7 hex) valid

DISKETTE DRIVE CONTROLLER  
SW4-6  
ON: Enables diskette drive controller  
OFF: Disables diskette drive controller

SERIAL PORT CHANNEL 2 (COM)  
SW4-5  
ON: Enables serial port channel 2  
OFF: Disables serial port channel 2

SERIAL PORT CHANNEL 1 (COM)  
SW4-4  
ON: Enables serial port channel 1  
OFF: Disables serial port channel 1

PARALLEL PORT  
SW4-3  
ON: Enables parallel port  
OFF: Disables parallel port

TOGGLE SWITCH — OPTIONAL  
DISPLAY TYPE SELECT

**NOTE** This switch setting only applies when an optional display is connected to the built-in Advanced Graphics Board (AGB). The setting has no effect on the PowerMate Portable display.

UP: APC IV Advanced Color Display (APC-H431) or other similar enhanced color display  
DOWN: Other color or monochrome display





Switch 3

← OFF  
ON →  
ON →  
← OFF

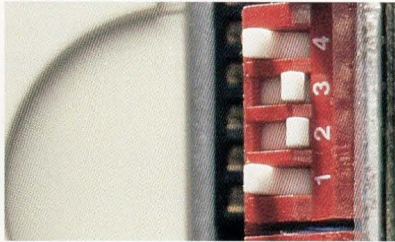

SW3-4  
SW3-3  
SW3-2  
SW3-1

SWITCH SETTINGS FOR AGB AS SECONDARY DISPLAY CONTROLLER BOARD

Switches				Configuration		
SW3-1	SW3-2	SW3-3	SW3-4	Advanced Graphics Board	Monochrome Board	Color/ Graphics Board
On	On	On	On	Color Display 40×25	Primary	—
Off	On	On	On	Color Display 80×25	Primary	—
On	Off	On	On	Enhanced Display Emulation Mode	Primary	—
Off	Off	On	On	Enhanced Display High Resolution Mode	Primary	—
On	On	Off	On	Monochrome	—	Primary 40×25
Off	On	Off	On	Monochrome	—	Primary 80×25

SWITCH SETTINGS FOR AGB AS PRIMARY DISPLAY CONTROLLER BOARD

Switches				Configuration		
SW3-1	SW3-2	SW3-3	SW3-4	Advanced Graphics Board	Monochrome Board	Color/ Graphics Board
On	Off	Off	On	Color Display 40×25	Secondary	—
Off	Off	Off	On	Color Display 80×25	Secondary	—
On	On	On	Off	Enhanced Display Emulation Mode	Secondary	—
Off	On	On	Off	Enhanced Display High Resolution Mode	Secondary	—
On	Off	On	Off	Monochrome	—	Secondary 40×25
Off	Off	On	Off	Monochrome	—	Secondary 80×25

**NOTE** These switch settings determine the function of the built-in AGB when it is acting as a secondary controller board. The primary board must be a monochrome or color/graphics board. You cannot install a second AGB in the PowerMate Portable.

**NOTE** These switch settings determine the function of the built-in AGB. If an optional monochrome or color/graphics board is also installed, the secondary board will function as described here. You cannot install a second AGB in the PowerMate Portable.

---

## Switch 2

The PowerMate Portable has a liquid crystal display (LCD) that displays black and white. It does not display colors or shades of gray. However, the LCD is designed to be used with software that does display colors. Switches 2-1 through 2-4 determine which colors will or will not be “translated” for black and white display on the LCD.

The factory settings for switches 2-1 through 2-4 allow all colors, except black, to display. All colors display on a black background. These settings accommodate most software applications.

To select a background color other than black, set switches 2-1 through 2-4 to indicate that your color choice is not displayed. This will create a contrast between the background color and the other foreground color(s) that you select for display. For example, if you have a software application that displays white characters on a blue background, set switch 2-1 to OFF and switches 2-2 through 2-4 to ON. These settings indicate that white is displayed and blue is not displayed.

If you forget to set your background color to “not displayed,” other foreground colors will not be visible on the LCD. They will appear to be the same color as the background.

**Switch 2**

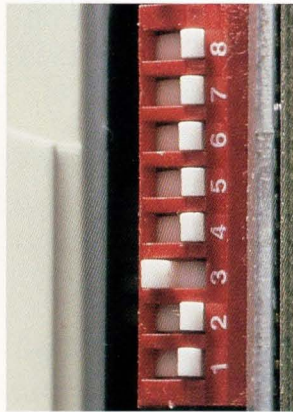

400-LINE MONITOR SELECT  
(EGA PLUS FUNCTIONS)  
SW2-8

ON: 200 line (normal) mode  
OFF: 400 line mode

EMULATION ENABLE/DISABLE  
(EGA PLUS FUNCTIONS)\*  
SW2-7

ON: Disable  
OFF: Enable

\* FOR CONTROLLER BOARDS SUCH AS  
COLOR GRAPHICS (CGA), MONOCHROME  
DISPLAY (MDA), AND HERCULES.

SW2-8

SW2-7

SW2-6

SW2-5

SW2-4

SW2-3

SW2-2

SW2-1

NORMAL/REVERSE DISPLAY SELECT  
SW2-6

ON: Selects normal display  
(black text on white background)  
OFF: Selects reverse display

DATA SAMPLING TIMING  
SW2-5

ON: At rising edge of DOCLK  
OFF: At falling edge of DOCLK

RGB DATA SELECT  
SW2-1

ON: Factory setting. See switch 2-4.  
OFF: See switch 2-4.

RGB DATA SELECT  
SW2-2

ON: Factory setting. See switch 2-4.  
OFF: See switch 2-4.

RGB DATA SELECT  
SW2-3

ON: See switch 2-4.  
OFF: Factory setting. See switch 2-4.

DISPLAY CONDITION  
SW2-4

ON: Refer to the table "Colors Displayed When Switch 2-4 Is On."

**COLORS DISPLAYED WHEN SWITCH 2-4 IS ON**

Colors Displayed	Switches 2-1, 2-2, 2-3 (0 = On, 1 = Off)							
	0,0,0	0,0,1	1,0,0	1,0,1	0,1,0	0,1,1	1,1,0	1,1,1
Black	Yes	No	No	No	No	No	No	No
Blue	Yes	Yes	No	No	No	No	No	No
Red	Yes	Yes	Yes	No	No	No	No	No
Magenta	Yes	Yes	Yes	Yes	No	No	No	No
Green	Yes	Yes	Yes	Yes	Yes	No	No	No
Cyan	Yes	Yes	Yes	Yes	Yes	Yes	No	No
Yellow	Yes	Yes	Yes	Yes	Yes	Yes	Yes	No
White	Yes	Yes	Yes	Yes	Yes	Yes	Yes	Yes

OFF: Refer to the table "Colors Displayed When Switch 2-4 Is Off."

**COLORS DISPLAYED WHEN SWITCH 2-4 IS OFF**

Colors Displayed	Switches 2-1, 2-2, 2-3 (0 = On, 1 = Off)							
	0,0,0	0,0,1	1,0,0	1,0,1	0,1,0	0,1,1	1,1,0	1,1,1
Black	Yes	No	No	No	No	No	No	No
Blue	No	Yes	No	No	No	No	No	No
Red	No	No	Yes	No	No	No	No	No
Magenta	No	No	No	Yes	No	No	No	No
Green	No	No	No	No	Yes	No	No	No
Cyan	No	No	No	No	No	Yes	No	No
Yellow	No	No	No	No	No	No	Yes	No
White	No	No	No	No	No	No	No	Yes



---

---

## CHANGE NOTICE

**DATE:** January 1988

**CHANGE NOTICE NUMBER:** 819-180001-000 Rev. 00  
**AFFECTED EQUIPMENT:** APC IV PowerMate Portable  
**AFFECTED DOCUMENT:** PowerMate Portable Owner's Guide  
(819-150785-000 Rev. 00)

Save this Change Notice page as a means of maintaining an up-to-date record of changes to the manual.

**COMMENTS:** To update your owner's guide, make the change to page 45 in the section "System Board Switch Settings."

**CHANGE NOTICE INSTRUCTIONS:** Changes are printed on adhesive paper. Peel the change page from its backing. Attach the change page over the original page by aligning the top line of text and the page number over the original ones.

All changes are indicated by vertical change bars in the outside margin opposite the affected information.

**DISPLAY CONDITION**

SW2-4

ON: Refer to the table "Colors Displayed When Switch 2-4 Is On."

**COLORS DISPLAYED WHEN SWITCH 2-4 IS ON**

Colors Displayed	Switches 2-1, 2-2, 2-3 (0 = On, 1 = Off)							
	0,0,0	0,0,1	0,1,0	0,1,1	1,0,0	1,0,1	1,1,0	1,1,1
Black	Yes	No	No	No	No	No	No	No
Blue	Yes	Yes	No	No	No	No	No	No
Green	Yes	Yes	Yes	No	No	No	No	No
Cyan	Yes	Yes	Yes	Yes	No	No	No	No
Red	Yes	Yes	Yes	Yes	Yes	No	No	No
Magenta	Yes	Yes	Yes	Yes	Yes	Yes	No	No
Yellow	Yes	Yes	Yes	Yes	Yes	Yes	Yes	No
White	Yes	Yes	Yes	Yes	Yes	Yes	Yes	Yes

OFF: Refer to the table "Colors Displayed When Switch 2-4 Is Off."

**COLORS DISPLAYED WHEN SWITCH 2-4 IS OFF**

Colors Displayed	Switches 2-1, 2-2, 2-3 (0 = On, 1 = Off)							
	0,0,0	0,0,1	0,1,0	0,1,1	1,0,0	1,0,1	1,1,0	1,1,1
Black	Yes	No	No	No	No	No	No	No
Blue	No	Yes	No	No	No	No	No	No
Green	No	No	Yes	No	No	No	No	No
Cyan	No	No	No	Yes	No	No	No	No
Red	No	No	No	No	Yes	No	No	No
Magenta	No	No	No	No	No	Yes	No	No
Yellow	No	No	No	No	No	No	Yes	No
White	No	No	No	No	No	No	No	Yes

## Switch 1

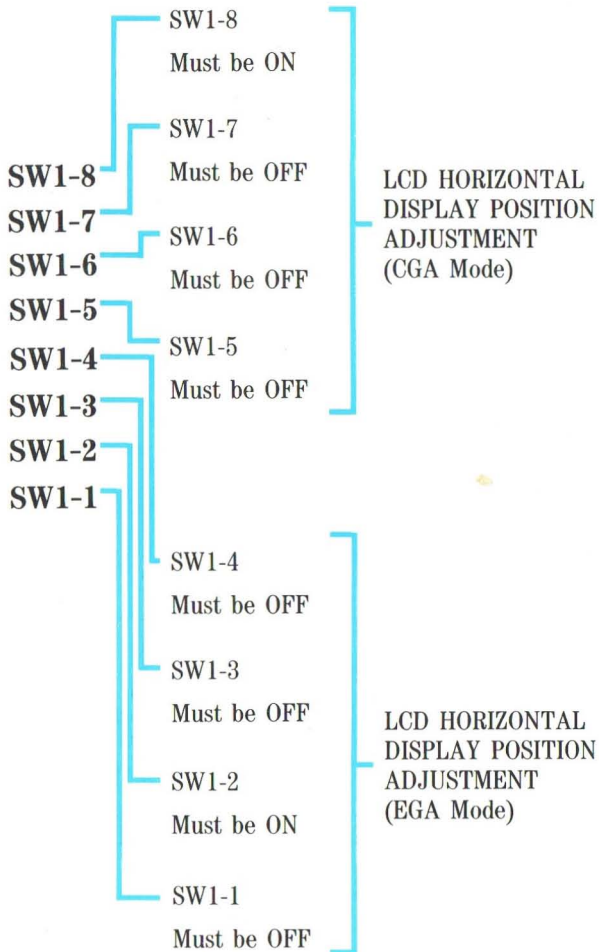
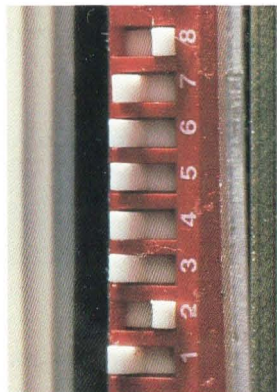

---

# Specifications

---

The following specifications are standard except where noted.

## **System Processor**

Intel  $\mu$ PD80286-10

Word length — 16 bits

Clock rate — 8/10 MHz, changeable through keyboard input as well as software selectable

## **Random-Access Memory (RAM)**

Standard size — 640 KB

Optional — two option slots available, total memory capacity expands to 4.6 MB

## **Read-Only Memory**

64 KB

## **Calendar Clock**

Year/month/day/hour/minute/second/0.01 second, battery-backed

Battery type — lithium, non-rechargeable

## **Input/Output (I/O) Facilities**

Parallel — one integrated port

RS-232C — one integrated serial port, asynchronous communication, up to 9600 bps

## **Option Slots**

Two slots — 8/16-bit full-size slots

One dedicated slot for the APC-H750 Internal Modem Board



---

## Display

High contrast, wide view, liquid crystal display

Screen size — 640 × 400 dots

Dot pitch — 0.323 mm × 0.42 mm

Dot size — 0.293 mm × 0.39 mm

Effective area — 217 mm × 173 mm

Dimensions — 270 mm × 210 mm × 13.5 mm

Electroluminescence (EL) backlight

## Keyboard

Design based on industry-standard keyboard

Total number of keys — 93

Special function keys — 12 keys, capable of up to 48 function selections

Status lamps for capital lock, numeric lock, and scroll lock keys

Numeric keypad — standard

Separate cursor control keys — standard

Interchangeable “Ctrl” and “Caps Lock” key caps

## Diskette Drives

### Packaging

- One internal 3½-inch, 720-KB drive — standard
- External 5¼-inch, 1.2-MB (APC-H723) or 5¼-inch, 360-KB (APC-H724) — optional

### Formatted Diskette Capacity

- APC-H723 — 1.2 MB
- APC-H724 — 360 KB

### Rotation Rate

- APC-H723 — 360 rpm
- APC-H724 — 300 rpm

### Transfer Rate

- APC-H723 — 500K bit/sec
- APC-H724 — 250K bit/sec

Controller and Advanced Graphics Board — implemented on system board

---

## Hard Disk Drives

### Packaging

- One internal 3½-inch, 20-MB drive standard for APC-H701
- One internal 3½-inch, 40-MB drive standard for APC-H702

### Formatted Disk Capacity

- APC-H701 — 20 MB
- APC-H702 — 40 MB

### Internal Configuration

- APC-H701 — two disks, four heads
- APC-H702 — four disks, eight heads

Number of Cylinders — 615

Data Transfer Rate — 625 KB/second

Rotation Rate — 3,600 rpm  $\pm$  0.5%

Access Time (average) — 40 ms

Start Time — 15 sec

Stop Time — 15 sec

Recording Method — Modified Frequency Modulation (MFM)

### Recording Density

- 14,000 bits per inch
- 850 tracks per inch

---

## **Dimensions**

### **System Unit**

- Height — 11.2 in. (28.4 cm)
- Width — 15.2 in. (38.6 cm)
- Depth — 6.9 in. (17.5 cm)

### **Keyboard**

- Height — 1.2 in. (3.0 cm)
- Width — 14.7 in. (37.3 cm)
- Depth — 10.3 in. (26.1 cm)

## **Weight**

- APC-H700 — 22.3 lbs
- APC-H701 — 24.0 lbs
- APC-H702 — 24.0 lbs

## **Power**

Universal power supply, 115/230 V, switch selectable

## **Recommended Operating Environment**

Temperature — 50° to 95°F (10° to 35°C)

Relative humidity — 20% to 80%

## **Operating System**

MS-DOS

## **Supplied Software**

MS-DOS Operating System

---

# Glossary

---

**applications programs** Programs designed for a specific purpose, such as for solving a particular business or mathematical problem.

**asynchronous communications** Method of data transmission where characters are preceded by a start bit and followed by a stop bit, permitting the time between characters to vary.

**bit** Binary digit. The smallest unit of computer data.

**board** Printed circuit board. Board onto which computer components are soldered and thin wires are printed to connect the components.

**boot** To start up a computer program.

**bps** Bits per second, a unit of transmission. Also called baud rate.

**busy lamp** Indicator on the front of diskette drive that lights when the drive is writing to or reading a diskette.

**byte** Group of eight bits.

**chip** Integrated circuit. A miniature circuit made by etching electronic components on a silicon wafer.

**clock** Electronic timer used to synchronize computer operations.

**cold boot** Restarting the computer by turning it off and then on.

**cursor** An image on the display screen that indicates where the next entered data will appear.

**diskette** A thin flexible platter coated with magnetic material for storing information.

**diskette drive** A magnetic device that writes on and retrieves data from a diskette.



---

**diskette release button** Button on the front of a 3½-inch diskette drive used to eject the microdiskette.

**double-density** Refers to how information is “packed” onto a diskette. Information on double-density diskettes is packed at twice the density of that on a single-density diskette.

**formatting** Preparing of a diskette to accept data.

**full-duplex transmission** Simultaneous two-way independent transmission.

**hard disk** A rigid magnetic storage device that provides fast access to stored data.

**hardware** The electronics and mechanical parts that a computer is made of.

**high capacity** Refers to the storage capacity of a diskette or diskette drive that uses high capacity diskettes.

**Hz** Hertz. A unit of frequency equal to one cycle per second.

**interface** A connection that enables two devices to communicate.

**KB** Kilobyte. 1024 bytes.

**LCD** Liquid crystal display.

**load** To enter a program into the computer’s memory from a storage device.

**MB** Megabyte. 1024 kilobytes; 1,048,576 bytes.

**memory** An electronic part of a computer that stores information.

**menu** A video display of programs or tasks.

---

**microdiskette** A 3½-inch diskette.

**microprocessor** A central processing unit (CPU) often contained on a single chip. One of the principal components of a microcomputer.

**modem** MODulator-DEModulator. A device that links computers over a telephone.

**monochrome** A video display that features different shades of a single color.

**option** Add-on hardware that expands the PowerMate Portable power and versatility.

**option slot** Location inside the system unit for the connection of an optional printed circuit board. There are three option slots available in the PowerMate Portable to expand the computer's capabilities.

**overwrite** Storing information at a location where information is already stored, thus destroying the original information.

**parallel interface** Interface that communicates eight bits at a time.

**parallel printer** A printer with a parallel interface.

**peripheral** Input or output device not under direct computer control.

**pixels** Picture elements. Tiny dots that make up a screen image.

**port** Place on a computer where a peripheral can be plugged in.

**processor** A computer on a chip.

**RAM** Random access memory. Temporary read/write memory that stores information only when the computer is on.

---

**read** To extract data from a storage device such as a diskette or memory.

**ROM** Read-only memory. Permanent computer memory that cannot be written to.

**RS-232C** Standard interface for serial devices.

**serial interface** An interface that communicates information one bit at a time.

**serial printer** A printer with a serial interface.

**software** Computer programs.

**synchronous communication** Method of data transmission where transmission is regulated by a clock.

**system board** The main printed circuit board inside the system unit into which other boards are connected.

**system unit** The PowerMate Portable component that contains the computer parts, disk drives, and option boards.

**VRAM** Video random access memory.

**write** To record or store information in a storage device.

**write protecting** Allows reading from a diskette but prevents writing to the diskette.

**writer protect tab** Sliding tab that allows a 3½-inch microdiskette to be write protected or write enabled.

---

# Index

---

## A

AC input, 17  
Accessories, 33  
Advanced Color Display, 30, 41  
Advanced Graphics Board, 41, 43  
Alt key, 15  
Automatic shutter, 23

## B

Beeping, 21, 35  
Boards, 31  
Boot-up, 21  
Busy lamp, 21

## C

Cable, 13, 33  
Cable channel, 19  
Cable storage tray, 6, 19  
Calendar clock, 47  
Caps Lock key, 19  
Care, 23, 29  
Carrying case, 33  
Clock speed, 15  
Chips, 31  
Color Graphics Adapter (CGA), 38, 45  
Color/graphics board, 43  
COM port, 17  
Comfort supports, 5, 19, 28  
Components, 2  
Connector cover, 12  
Contrast dial, 15, 21  
Controller, 43, 48  
Ctrl key, 19  
Cursor control keys, 19

## D

Dedicated slot, 18, 47  
Dimensions, 50  
Disk busy lamp, 15  
Diskette damage, 26  
Diskette drive busy lamp, 16  
Diskette drive controller, 41  
Diskette drive designation, 41  
Diskette drives, 32, 48  
Diskette release button, 16  
Display, 2, 15, 30  
Drives, 3, 32, 41

## E

Eject, 22  
Enhanced Graphics  
  Adapter (EGA), 38, 45  
Enhanced keyboard, 11, 12, 30  
Entry menu, 21  
Expansion slot cover, 17  
External diskette drive, 3, 32, 48

## F

FDD port, 11  
files, 27  
function keys, 19

## G

Graphics characters, 37

## H

Hard disk, 27  
Hard disk drives, 32, 49  
Hard disk kit, 32



---

## I

Input/output facilities, 47  
Inserting a microdiskette, 24  
Interchangeable keys, 19  
Internal configuration, 49  
Internal drives, 49  
Internal modem board, 31

## J

Jacket, 23

## K

Keyboard  
  Enhanced, 11, 12, 30  
  connector, 12, 16

## L

LCD, 44, 48

## M

Math coprocessor, 31  
Memory expansion board, 31  
Memory expansion kit, 31  
Microdiskettes  
  formatting, 23  
  inserting, 24  
  precautions, 26  
  release button, 16  
  removing, 24  
  write protecting, 25  
Models, 3  
Monochrome board, 43  
Monochrome display, 2, 15  
Movable handle, 18  
Moving, 27  
MS-DOS system diskette, 21

## N

Numeric keypad, 19  
Num Lock key, 19  
Num Lock lamp, 19

## O

Operating environment, 4  
Operating system, 50  
Option slots, 17, 18, 47

## P

Peripheral options, 11  
Power cord, 9  
Power lamp, 15  
Power on screen, 21  
Power supply switch, 9  
Power switch, 9, 17  
Precautions, 26  
Printer cable, 13, 33  
PRINTER port, 17  
Problem solving, 36  
Processor, 47

## R

Random-access memory, 27, 47  
Read-only memory, 47  
Recommended operating  
  environment, 50  
Removing a microdiskette, 24  
RESET button, 16  
Reverse display select, 45  
RGB data select, 45  
RGB port, 17  
RS-232C cable, 33  
RS-232C connector, 17

---

## **S**

Serial port, 17

Specifications, 47

Status lamps, 19

Supplied software, 50

Switch cover, 38

Switch settings, 39

System processor, 47

System setup program, 22

System unit, 2

## **T**

Toggle switch, 41

Top option slot cover, 18

## **U**

Universal power supply, 50

## **W**

Weight, 50

Write protection, 25



**USER'S COMMENTS FORM****Document:** APC IV PowerMate Portable Owner's Guide**Document No.:** 819-150785-000 Rev. 00

Please suggest improvements to this manual.

---

---

---

---

---

---

---

---

---

---

Please list any errors in this manual. Specify by page.

---

---

---

---

---

---

---

---

---

---

**From:**

Name \_\_\_\_\_

Title \_\_\_\_\_

Company \_\_\_\_\_

Address \_\_\_\_\_

Date: \_\_\_\_\_



Seal or tape all edges for mailing – do not use staples

FOLD HERE



NO POSTAGE  
NECESSARY  
IF MAILED  
IN THE  
UNITED STATES

**BUSINESS REPLY CARD**

FIRST CLASS PERMIT NO. 105 BOXBOROUGH, MA

*POSTAGE WILL BE PAID BY ADDRESSEE*

**NEC Information Systems, Inc.**

Dept: Publications

1414 Mass. Ave.

Boxborough, MA 01719



FOLD HERE

Seal or tape all edges for mailing – do not use staples



**C&C**  
Computers and Communications

819-150785-000 Rev. 00  
Copyright 11-87 Printed in U.S.A.

**NEC**

NEC Information Systems, Inc.  
1414 Massachusetts Avenue, Boxborough, MA 01719

## FCC INFORMATION TO USER

To ensure compliance of this unit to the Class B limits of the FCC Rules; Part 15, Subpart J, the enclosed ferrite core kit has been provided.

It is to be used when non-NEC keyboards or video cables are used with this unit.

Please refer to the instructions on this sheet for proper installation of this kit.

Additional FCC information may be found in the radio frequency interference statement located in the owners guide.

## INSTALLATION INSTRUCTIONS

1. Place both halves of the ferrite core over the cable as close as possible to the connector that goes to the computer.

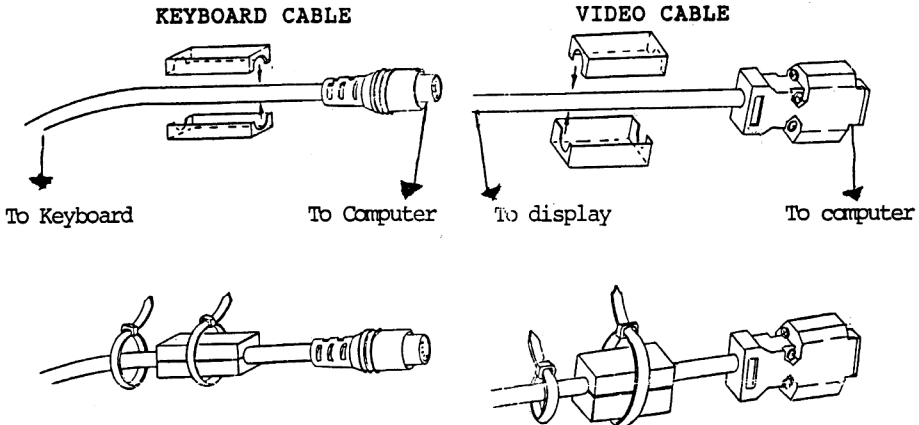

2. Secure the halves of the ferrite core with a tie wrap.
3. Place an additional tie wrap over the cable next to the core.
4. Draw the tie wraps tight and cut off the excess tie wrap lead.

P/N 819-150784-000