



# **IBM ThinkPad 600 User's Reference**







# **IBM ThinkPad 600 User's Reference**

IBM



**Note**

Before using this information and the product it supports, be sure to read the general information under "Safety Information" on page xiii, "Ergonomics Information" on page 40, and "Notices" on page 173.

**First Edition (January 1998)**

**The following paragraph does not apply to the United Kingdom or any country where such provisions are inconsistent with local law:**

INTERNATIONAL BUSINESS MACHINES CORPORATION PROVIDES THIS PUBLICATION "AS IS" WITHOUT ANY WARRANTY OF ANY KIND, EITHER EXPRESS OR IMPLIED, INCLUDING, BUT NOT LIMITED TO, THE LIMITED WARRANTIES OF MERCHANTABILITY OR FITNESS FOR A PARTICULAR PURPOSE. Some states do not allow disclaimers or express or implied warranties in certain transactions; therefore, this statement may not apply to you.

This publication could include technical inaccuracies or typographical errors. Changes are periodically made to the information herein; these changes will be incorporated in new editions of the publication. IBM may make improvements or changes in the products or the programs described in this publication at any time.

Requests for technical information about IBM products should be made to your IBM Authorized Dealer or your IBM Marketing Representative.

**Copyright International Business Machines Corporation 1998. All rights reserved.** Note to US Government Users – Documentation related to restricted rights – Use, duplication, or disclosure is subject to restrictions set forth in GSA ADP Schedule Contract with IBM Corp.



## ***Thank You for Selecting an IBM ThinkPad 600 Computer***

We have developed this ThinkPad computer to meet both your technical requirements and your high expectations. To help us continue to build products that address your mobile computing needs, please take a moment to complete the ThinkPad\* Registration in the *Setup Guide*.

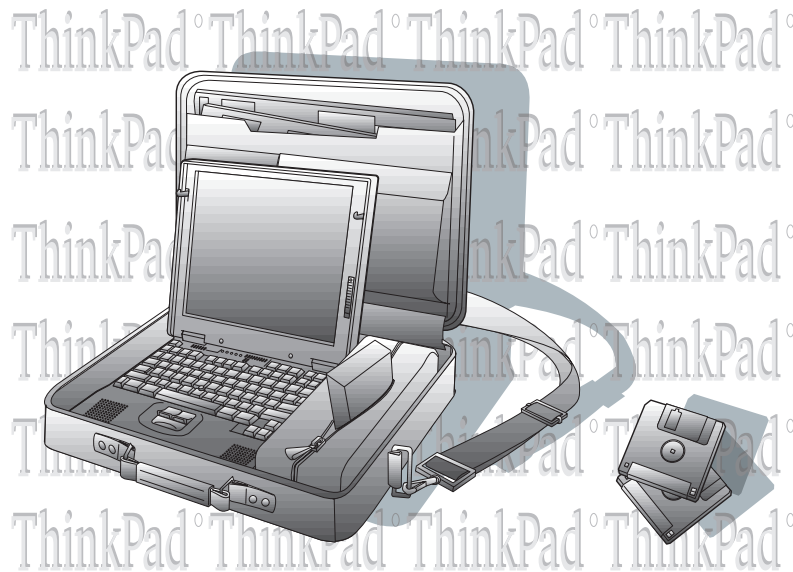

## Functional Highlights

### *Compact design with core technology*

The slim, lightweight, and portable design of the ThinkPad 600 makes traveling with your computer much easier. Your computer is available wherever and whenever you need it.

### *High-speed processor*

The Intel high-speed processor enables high-speed data processing and provides advanced performance.

### *Large-capacity hard disk drive*

The large-capacity hard disk drive can respond to a wide variety of your business demands.

### *Large color LCD*

The large TFT (thin-film transistor) or HPA (high performance addressing) display provides clear and brilliant text and graphics.

### *Lithium-ion battery pack*

The large-capacity lithium-ion battery pack extends the operating time of your computer, further enhancing to its portability.

### *Audio with 3D stereo sound*

Your computer is equipped with internal audio record and playback capabilities including 3D audio from just two speakers. When you enable the 3D stereo feature, sounds will appear to be generated all around you, even though only two speakers are used.

The audio feature supports the following:

- Wave audio recording and playback of up to 16 bits, stereo, and 44 KHz sampling.

- DOS games using the Sound Blaster Pro\*\* interface.

The model equipped with a digital signal processor (DSP), called the IBM Advanced Communication Processor, features a high-quality MIDI wave table synthesizer with 128 instruments and up to 32 voices.

To use the audio function → Online book

### *ThinkPad modem*

The ThinkPad modem enables you to send or receive data, faxes, and voice over a telephone line. This modem uses a digital signal processor (DSP), called the IBM Advanced Communication Processor, and its software can be upgraded, allowing great flexibility.

To use the ThinkPad modem function → Online book

### *TrackPoint\* with enhanced controls*

Your computer has an enhanced TrackPoint function that enables you to make selections merely by pressing on the TrackPoint. A new center button converts the TrackPoint into a scroll controlling device or a magnifying glass on the screen.

To use the TrackPoint → "TrackPoint" on page 8

### *PC Card support*

Your computer provides two PC Card slots that accept a 16-bit PC Card, CardBus Card, and Zoomed Video Card.

To install the PC Card → "Inserting a PC Card" on page 72





# Contents

Functional Highlights . . . . .	iv
About This Book . . . . .	xi
Safety Information . . . . .	xiii
Laser Compliance Statement . . . . .	xv
<b>Chapter 1. Getting Familiar with Your Computer . . . . .</b>	<b>1</b>
Identifying the Hardware Features . . . . .	2
Rear View of the Computer . . . . .	5
Bottom View of the Computer . . . . .	5
System-Status Indicators . . . . .	6
Functions of Your Computer . . . . .	8
Keyboard Functions . . . . .	8
UltraslimBay . . . . .	15
ThinkPad Utility Programs . . . . .	16
Online Book . . . . .	31
Backing Up Your System . . . . .	32
ThinkPad Customization CD . . . . .	32
Recovery CD . . . . .	32
Diskette Factory . . . . .	32
ConfigSafe . . . . .	33
ThinkPad Web Site or Bulletin Board . . . . .	33
Replacing the Battery Pack . . . . .	34
Handling Your Computer . . . . .	36
ThinkPad Don'ts . . . . .	36
ThinkPad Do's . . . . .	37
Cleaning Your Computer . . . . .	38
Carrying Your Computer . . . . .	38
Extending Your Computer's Battery Life . . . . .	39
Ruggedized Mobile Computers . . . . .	40
Ergonomics Information . . . . .	40
For More Information . . . . .	42
<b>Chapter 2. Extending the Features of Your Computer . . . . .</b>	<b>43</b>
Customizing the TrackPoint . . . . .	44
Increasing Memory . . . . .	49
Upgrading the Hard Disk Drive . . . . .	55
Replacing the UltraslimBay Device . . . . .	57
Attaching the Diskette Drive Externally . . . . .	61
Removing the Diskette Drive from the Enclosure . . . . .	62
Attaching an External Mouse, Keypad, and Keyboard . . . . .	63

Attaching an External Mouse or Numeric Keypad . . . . .	63
Attaching an External Keyboard and Mouse . . . . .	64
Disabling the TrackPoint . . . . .	66
Attaching an External Monitor . . . . .	67
Display Output Location . . . . .	68
Display Modes . . . . .	70
Inserting a PC Card . . . . .	72
Removing the PC Card . . . . .	75
Using a Docking Station . . . . .	76
<b>Chapter 3. Protecting Your Computer . . . . .</b>	<b>85</b>
Using Passwords . . . . .	86
Entering a Password . . . . .	87
Setting a Password . . . . .	88
Changing and Removing a Password . . . . .	92
Power-On Password with Supervisor Authority . . . . .	96
Using the Personalization Editor . . . . .	98
Entering Your Personal Data . . . . .	98
Deleting the Personalization Window . . . . .	101
Using Locks . . . . .	102
<b>Chapter 4. Solving Computer Problems . . . . .</b>	<b>103</b>
Frequently Asked Questions . . . . .	104
Hints, Tips, and Limitations . . . . .	111
Using the Power Management Modes . . . . .	113
Using a PC Card with the Docking Station . . . . .	113
USB Connector Considerations . . . . .	113
Using a Second CardBus Card . . . . .	114
Using an External Condenser Microphone . . . . .	114
Using the NetMeeting Software . . . . .	115
Troubleshooting Guide . . . . .	116
Troubleshooting Charts . . . . .	117
Error Codes or Messages . . . . .	118
No Error Codes or Messages . . . . .	122
Input Problems . . . . .	123
Suspend or Hibernation Problems . . . . .	124
LCD Problems . . . . .	128
An Indicator Problem . . . . .	129
Battery Problems . . . . .	129
CD-ROM Drive Problems . . . . .	130

Infrared Communication Problems	131
An Audio or a Telephony Problem	132
A Universal Serial Bus (USB) Problem	132
A Modem Problem	133
PC Card Problems	134
Docking Station Problems	137
A Printer Problem	138
External Monitor Problems	139
Port Replicator Problems	140
Other Option Problems	141
Software Problems	142
Other Problems	142
Testing Your Computer	144
Test the SelectaDock I and II	146
Recovering Lost or Damaged Software	147
Using the Diskette Factory	148
Using the ThinkPad Customization CD	149
Using the Recovery CD	150
<b>Chapter 5. Getting Service</b>	<b>153</b>
Information on Your Computer	154
Option List	154
Identification Numbers	154
Problem Recording Sheet	155
Customer Support and Service	156
Help by Telephone	156
ThinkPad EasyServ	157
Getting Help around the World	157
Fax Information	157
Electronic Support Services	158
Purchasing Additional Services	160
Enhanced PC Support Line	160
Client Support Line	160
Network and Server Support Line	161
Ordering Support Line Services	162
Warranty and Repair Services	163
Obtaining IBM Operating System Updates	164
Getting Update Diskettes	164
Ordering Publications	164

<b>Appendix A. Features and Specifications</b> . . . . .	165
Features . . . . .	165
Specifications . . . . .	167
IBM Power Cords . . . . .	168
<b>Appendix B. Product Warranties and Notices</b> . . . . .	169
Notices . . . . .	173
Trademarks . . . . .	173
Electronic Emission Notice . . . . .	174
Telecommunication Notice . . . . .	176
Industry Canada Requirements . . . . .	178
<b>Glossary</b> . . . . .	181
<b>Index</b> . . . . .	185

## About This Book

This book contains information that will help you operate the IBM ThinkPad 600 computer. Be sure to read the *ThinkPad Setup Guide* and Chapter 1 of this book before using the computer.

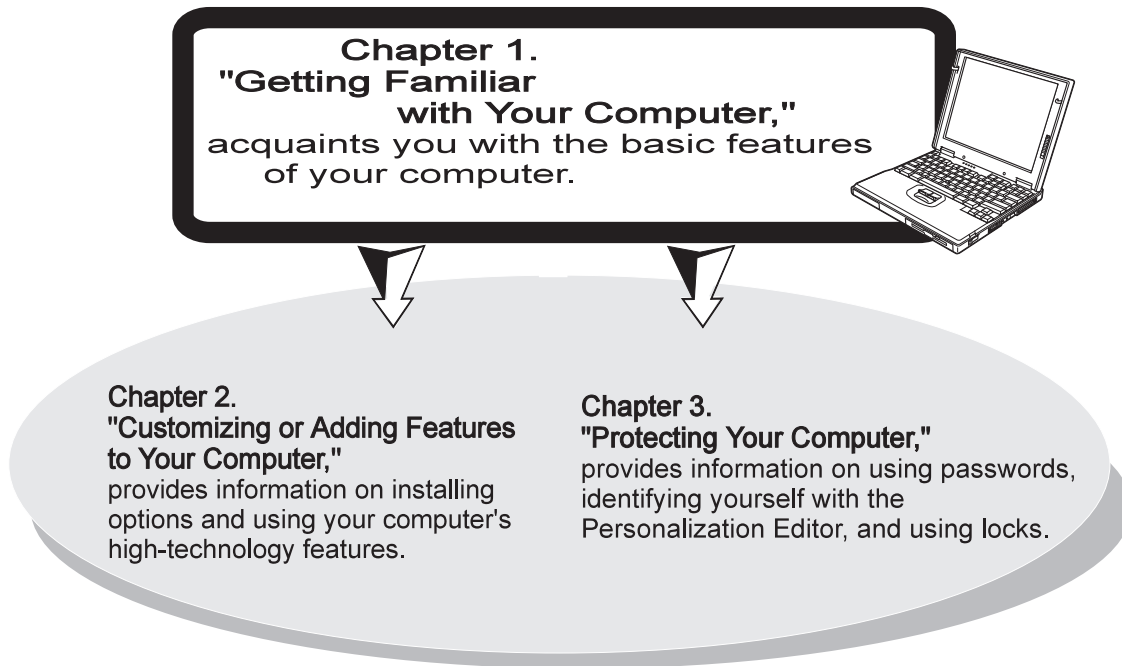

**Chapter 4. "Solving Computer Problems,"**  
describes what to do when you have a computer problem. The chapter includes a troubleshooting guide and information on how to recover lost or damaged software.

**Chapter 5. "Getting Service,"**  
describes various options of IBM's support and service.

**Appendix A, "Features and Specifications,"** describes the features and specifications associated with your computer, including information on power cords.

**Appendix B, "Product Warranties and Notices,"** contains the warranty statements for your computer and notices for this book.

The **glossary** defines terms appearing in this book. The book concludes with an **index**.



### Icons Used in This Book

For procedures or information unique to the operating system installed in your computer:



Information for IBM OS/2 users.



Information for IBM DOS users.



Information for Microsoft Windows 3.11 users.



Information for Microsoft Windows NT users.



Information for Microsoft Windows 95 users.



# Safety Information

## Electrical Safety Notice

**Note:** In the U.K., by law:

The telephone line cable must be connected after the power cord.  
The power cord must be disconnected after the telephone line cable.



**Electrical current from power, telephone, and communication cable is hazardous. To avoid shock hazard, connect and disconnect cables as shown below when installing, moving, or opening the covers of this product or attached devices. The 3-pin power cord must be used with a properly grounded outlet.**

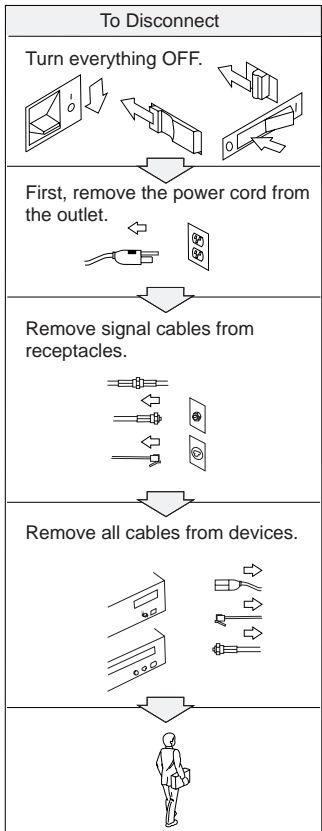
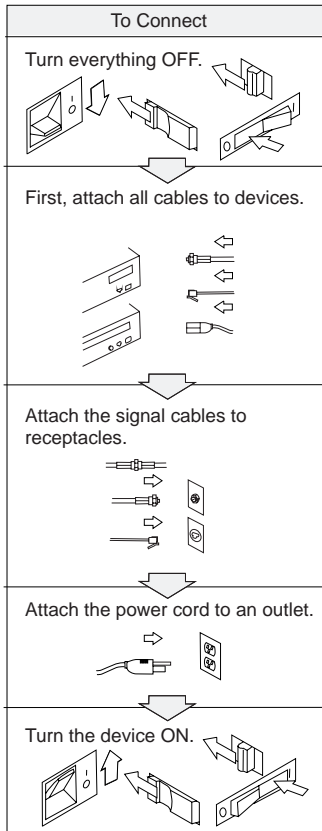

 **DANGER**

**Do not disassemble, incinerate, or short-circuit the rechargeable battery pack. Do not put it in trash that is disposed of in landfills. Dispose of it as required by local ordinances or regulations. In the United States, call IBM at 1-800-IBM-4333 for information on disposal.**

**CAUTION:**

The lithium battery (IBM P/N 02K6502 UL-recognized component—File No. MH12210) can be replaced only by your dealer or an IBM service representative. It contains lithium and can explode if not properly used, handled, or disposed of. Do not: (1) throw or immerse into water, (2) heat to more than 100°C (212°F), or (3) attempt to repair or disassemble. Dispose of it as required by local ordinances or regulations.

**CAUTION:**

The fluorescent lamp in the liquid crystal display (LCD) contains mercury. Do not put it in trash that is disposed of in landfills. Dispose of it as required by local ordinances or regulations.

The LCD is made of glass, and rough handling or dropping the computer can cause the LCD to break. If the LCD breaks and the internal fluid gets into your eyes or on your hands, immediately wash the affected areas with water for at least 15 minutes; then get medical care if any symptoms are present after washing.



## Laser Compliance Statement

The CD-ROM drive of the IBM ThinkPad 600 computer is a laser product. The CD-ROM drive's classification label (shown below) is located on the top of the drive.

CLASS 1 LASER PRODUCT  
LASER KLASSE 1  
LUOKAN 1 LASERLAITE  
APPAREIL A LASER DE CLASSE 1  
KLASS 1 LASER APPARAT

The CD-ROM drive is certified in the U.S. to conform to the requirements of the Department of Health and Human Services 21 Code of Federal Regulations (DHHS 21 CFR) Subchapter J for Class I laser products.

In other countries, the drive is certified to conform to the requirements of EN60825.



### **CAUTION:**

**Do not open the CD-ROM drive; no user adjustments or serviceable parts are inside.**

**Use of controls, adjustments, or the performance of procedures other than those specified may result in hazardous radiation exposure.**

Class I laser products are not considered to be hazardous. The CD-ROM drive has an internal, Class I, 0.5-milliwatt, aluminum gallium-arsenide laser that operates at a wavelength of 760 to 810 nanometers. The design of the laser system and the CD-ROM drive ensures that there is no exposure to laser radiation above a Class I level during normal operation, user maintenance, or servicing conditions.



# Chapter 1. Getting Familiar with Your Computer

---

This chapter provides basic information about your computer.

Identifying the Hardware Features . . . . .	2
Rear View of the Computer . . . . .	5
Bottom View of the Computer . . . . .	5
System-Status Indicators . . . . .	6
Functions of Your Computer . . . . .	8
Keyboard Functions . . . . .	8
TrackPoint . . . . .	8
Fn Key . . . . .	11
Numeric Keypad . . . . .	13
UltraslimBay . . . . .	15
ThinkPad Utility Programs . . . . .	16
Easy-Setup . . . . .	16
ThinkPad Configuration Program . . . . .	24
Online Book . . . . .	31
Backing Up Your System . . . . .	32
ThinkPad Customization CD . . . . .	32
Recovery CD . . . . .	32
Diskette Factory . . . . .	32
ConfigSafe . . . . .	33
ThinkPad Web Site or Bulletin Board . . . . .	33
Replacing the Battery Pack . . . . .	34
Handling Your Computer . . . . .	36
ThinkPad Don'ts . . . . .	36
ThinkPad Do's . . . . .	37
Cleaning Your Computer . . . . .	38
Carrying Your Computer . . . . .	38
Extending Your Computer's Battery Life . . . . .	39
Ruggedized Mobile Computers . . . . .	40
Ergonomics Information . . . . .	40
For More Information . . . . .	42

## Identifying the Hardware Features

# Identifying the Hardware Features

### Front View of the Computer

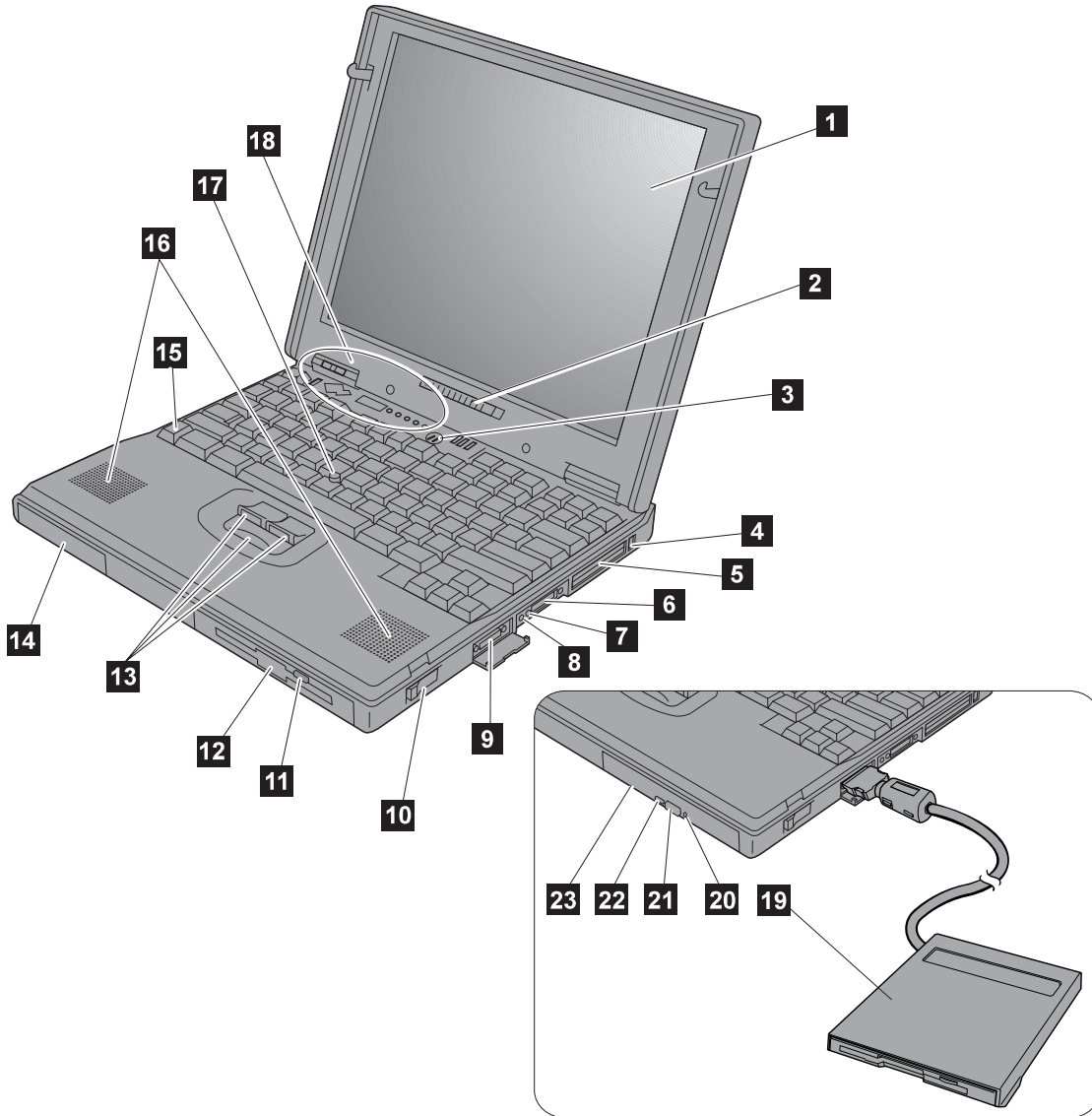

## Identifying the Hardware Features

- 1 The **color LCD screen** displays computer output.
- 2 The **brightness control (for TFT)** adjusts the brightness of the display.  
The **contrast control (for HPA)** adjusts the contrast of the display.
- 3 The **built-in microphone** captures sound and voice when it is used with an application program capable of handling audio.
- 4 The **PC Card eject buttons** eject the PC Card from the PC Card slot.
- 5 The **PC Card slots** accept PC Cards.
- 6  The **infrared port** allows the computer to communicate with other devices that have infrared data-transfer capability.
- 7 The **headphone jack**, a  $\frac{1}{4}$ -inch (3.5-mm) diameter jack, is where you connect a stereo headphone or external speakers.
- 8 The **microphone/line-in jack**, a  $\frac{1}{4}$ -inch (3.5-mm) diameter jack, is where you connect a stereo microphone or an external audio device.
- 9 The **external diskette drive connector** is where you connect the cable of the external diskette drive.
- 10 The **LCD latch** opens the LCD when pressed.
- 11 The **diskette-eject button** ejects the diskette from the diskette drive.
- 12 The **diskette-drive** is the drive for the UltraslimBay.
- 13 The **TrackPoint buttons** work with the TrackPoint stick 17 and provide a function similar to that of a mouse button.
- 14 The **hard disk drive** is the built-in hard disk drive of the computer.
- 15 The **Fn key** is used with the function keys to activate the **Fn key** functions.
- 16 The left and right **internal speakers** generate stereo sound.
- 17 The **TrackPoint stick** is a built-in pointing device that provides a function similar to that of a mouse.
- 18 The **system-status indicators** consist indicators and their associated symbols.
- 19 You can attach the diskette drive as an **external diskette drive** if another device is in the UltraslimBay.
  - 20 The **emergency hole** is used to eject the CD-ROM tray if it does not open with the eject button.
- 21 The **CD-ROM eject button** ejects the CD-ROM tray.
- 22 The **CD-ROM access indicator** is on when data is read from a CD-ROM in the CD-ROM drive.
- 23 The **CD-ROM drive** is the drive for the UltraslimBay.

## Identifying the Hardware Features



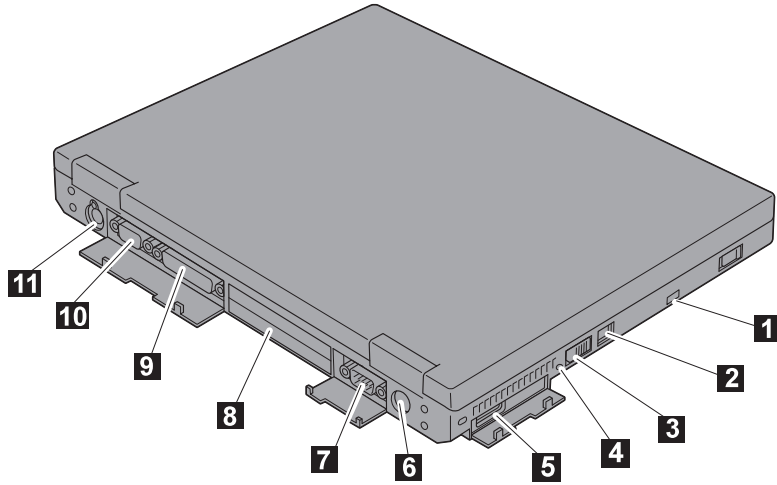



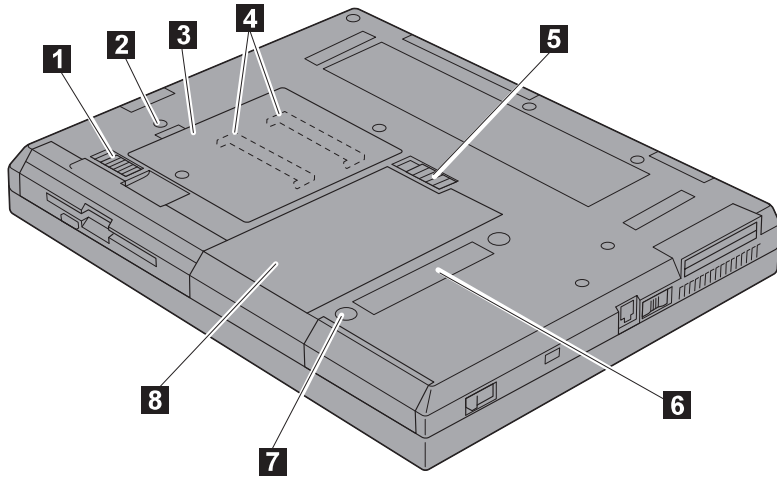

### Rear View of the Computer



### Bottom View of the Computer



## Rear View of the Computer

- 1  The **security keyhole** is used with a mechanical lock.
- 2  The **modem connector** is used for connecting your computer to a telephone line.
- 3 The **power switch** turns the computer on and off.
- 4 The **reset switch** is used to turn the computer off if an application hangs or if the computer will not accept any input. Use the tip of a pen to press this switch.
- 5  The **universal serial bus (USB) connector** allows you to connect any device that conforms to this new interface. Many recent digital devices comply to this new standard.
- 6  The **power jack** is where the AC Adapter cable is connected.
- 7  The **serial connector** is where you connect a 9-pin, serial-device cable.
- 8  The **system-expansion connector** (240-pin) allows you to connect the port replicator or docking station.
- 9  The **parallel connector** is where you connect a parallel-printer signal cable.
- 1  The **external-monitor connector** is where you attach the external monitor.
- 11  The **external-input-device connector** is used to attach a mouse, external keyboard, or external numeric keypad to the computer.

## Bottom View of the Computer

- 1 The **UltraslimBay device lock** is a lock for the device in the UltraslimBay.
- 2 When the **bay LED** is on, the system is in use. Do not remove a bay device.
- 3 The **memory-slot cover** covers the memory slot.
- 4 The **memory slot** accepts an SDRAM dual inline memory module (DIMM) option.
- 5 The **battery-pack latch** locks or releases the battery pack.
- 6 Put your name plate here.
- 7 To remove the hard disk, loosen this **hard disk screw**. You can use the security screw shipped with your computer as a hard disk screw.
- 8 The **battery pack** is a built-in power source for the computer.



## System-Status Indicators





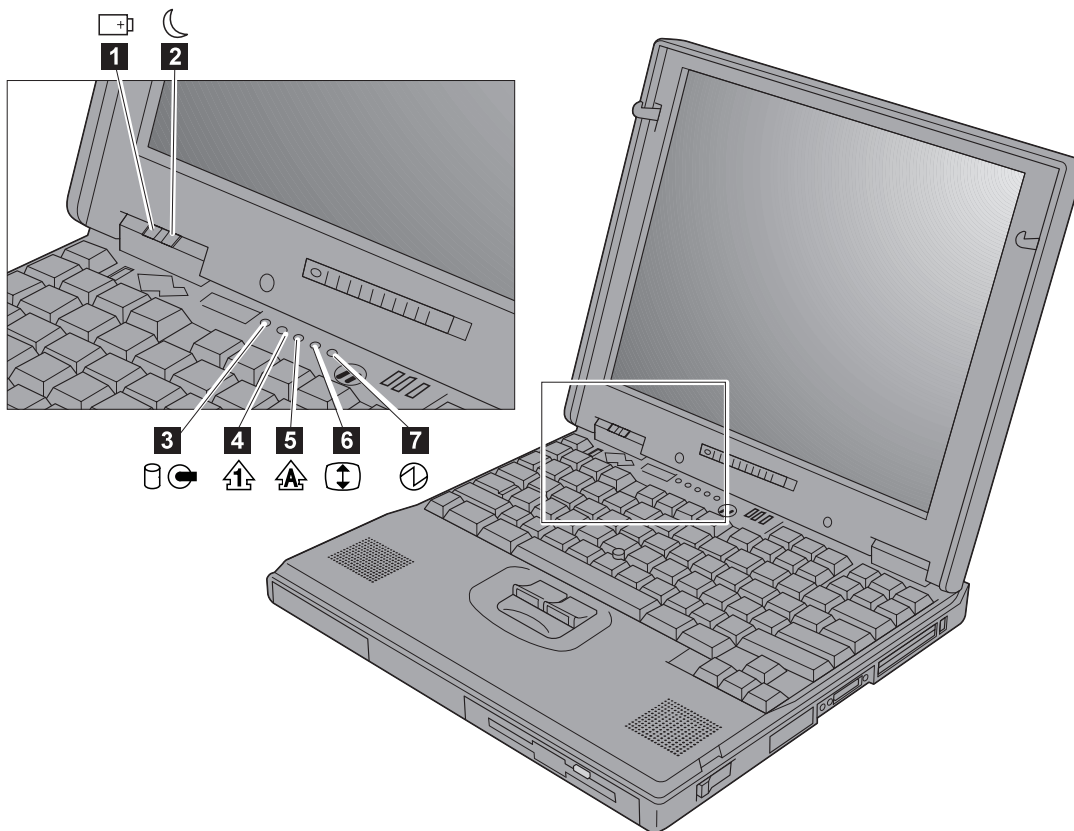

# System-Status Indicators

The system-status indicators on the computer show the current status of your computer by their on or off states and colors (green and orange). Each indicator is identified with a symbol. The following shows the location and the meaning of each icon:





## System-Status Indicators

Symbol	Color	Meaning
1 Battery status 	Green	Enough battery power remains for operation.
	Blinking orange	The battery pack needs to be charged.
	Orange	The battery pack is being charged.
2 Suspend mode 	Green	The computer is in suspend mode.
	Blinking green	The computer is entering suspend or hibernation mode or is resuming normal operation.
3 Hard disk in use 	Orange	Data is being read from or written to the hard disk. Do not enter the computer suspend mode or power off the computer when this indicator is on.
4 Numeric lock 	Green	The numeric keypad on the keyboard is enabled. You enable or disable the keypad by pressing and holding the <b>Shift</b> key, and pressing the <b>NumLk</b> key. For details, see “Numeric Keypad” on page 13.
5 Caps lock 	Green	Caps Lock mode is enabled. All alphabetic characters (A–Z) are entered in capital letters without the <b>Shift</b> key being pressed. You enable or disable Caps Lock mode by pressing the <b>Caps Lock</b> key.
6 Scroll lock 	Green	Scroll Lock mode is enabled. The <b>Arrow</b> keys can be used as screen-scroll function keys. The cursor cannot be moved with the <b>Arrow</b> keys. <i>Not all application programs support this function.</i> You enable or disable Scroll Lock mode by pressing the <b>ScrLk</b> key.
7 Power on 	Green	The computer is operational. This indicator is on when the computer is on and not in suspend mode.

## *Distinctive Functions of Your Computer*

# Functions of Your Computer

This section includes the following topics:

- Keyboard functions
- UltraslimBay
- ThinkPad utilities
- Online book

## Keyboard Functions

Your computer's keyboard has the following functions:

- TrackPoint
- Fn key
- Numeric keypad

### *TrackPoint*

The keyboard contains a unique cursor-pointing device called the *TrackPoint*. Pointing, selecting, and dragging all become part of a single process you can perform without moving your fingers from their typing position.

**Note:** The TrackPoint driver is required for the unique TrackPoint functions such as Press-to-Select, Scrolling, or the Magnifying Glass.

## Distinctive Functions of Your Computer

The TrackPoint pointing device consists of a **stick** on the keyboard and three **click buttons** below the keyboard. Movement of the cursor on the screen is controlled by the amount of pressure that you apply to the nonslip cap on the stick in any direction parallel to the keyboard; the stick itself does *not* move. The speed at which the cursor moves corresponds to the pressure you apply to the stick. The function of the click buttons depends on the software you are using.

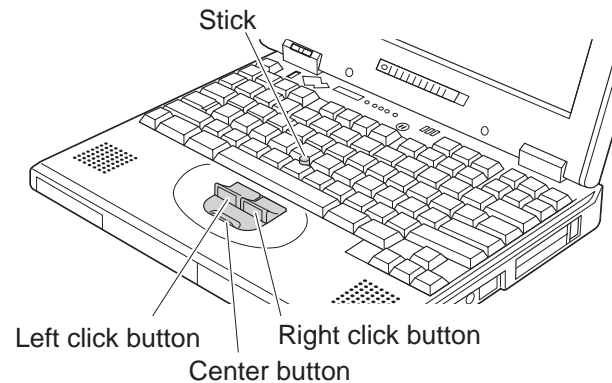

If you are not familiar with using the TrackPoint, these instructions will help you get started:

- 1** Place your hands in the typing position and press gently with either index finger on the stick in the direction you want the cursor to move.

Pressing the stick away from you moves the cursor up the screen; pressing it toward you moves the cursor down the screen. You can also move the cursor side to side by pressing sideways.

**Note:** The cursor may drift. This is not a defect. Do not use the TrackPoint until the cursor stops moving.

## Distinctive Functions of Your Computer

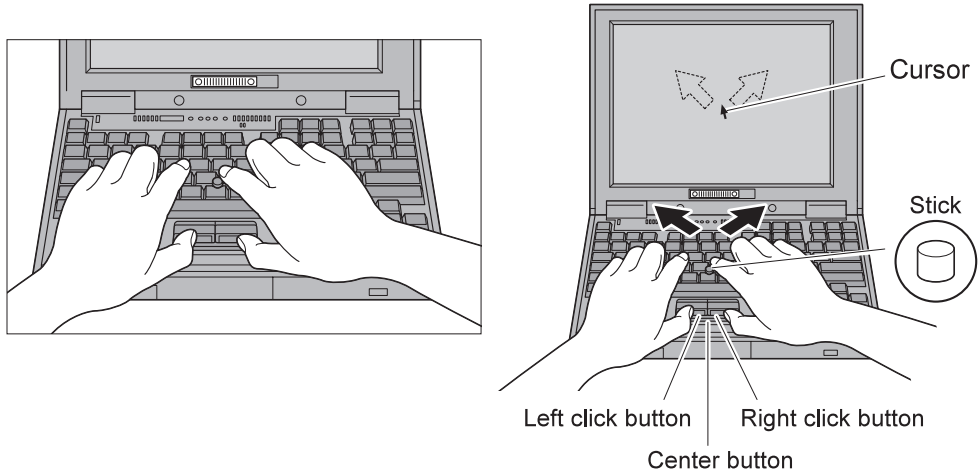

- 2 Press the click buttons with either thumb to select and drag as required by your software.

### Changing the Cap

The cap 1 on the end of the TrackPoint is removable. You can replace it with one of the spares shipped with your computer.

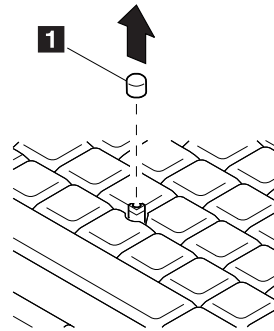

For customizing the TrackPoint → “Customizing the TrackPoint” on page 44 .

## *Fn Key*

The **Fn** key function allows you to change operational features instantly. When you use the following functions, press and hold the **Fn** key <sup>1</sup>; then press the appropriate function key <sup>2</sup> (**F1** to **F12**, **PgUp**, **PgDn**, or **BackSpace**.)

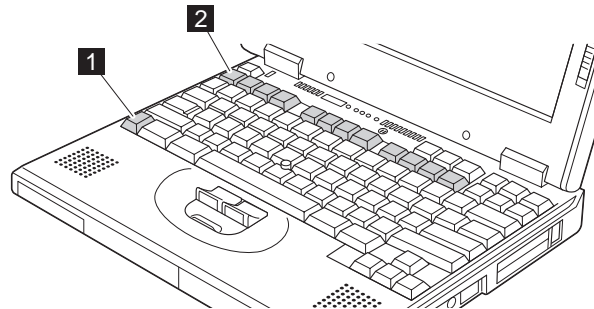

### **The Fn Key Lock Function**

The following setup gives you the same effect as when you press and hold the **Fn** key and then press an appropriate function key:









Start the ThinkPad Configuration program, (See “ThinkPad Configuration Program” on page 24.) click on **Accessibility** (  ) button, and click on **Enable** for **Fn key lock**. You can also set up by typing `PS2 FNS E` at the command prompt.

After you enable the **Fn** key lock and press **Fn** *once*, press one of the function keys. The computer works the same as when you press **Fn** + the function key.

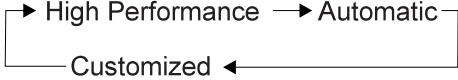

If you press **Fn** *twice* after enabling the lock, pressing a function key alone is recognized as a combination of **Fn** + that function key. To stop this function, press **Fn** again.

## Distinctive Functions of Your Computer

The following table shows the function of the **Fn** key combined with keys:

Feature and icon	Key Combination	Meaning
<b>Power Mode Functions</b>		
Fuel-Gauge display on or off 	<b>Fn</b> + <b>F2</b> (Only for OS/2 or Windows users)	If you press this key combination, the window for the battery status appears or disappears. You can set parameters for battery status in the window.  <b>Note:</b> The Fuel-Gauge program must be activated before you can use this key combination.  To activate the Fuel-Gauge program, do the following: <ol style="list-style-type: none"> <li>1. Click on <b>Start</b>.</li> <li>2. Move the cursor to <b>Programs, ThinkPad</b>, and then click on <b>Fuel</b>.</li> </ol>
Power mode switching 	<b>Fn</b> + <b>F11</b>	During battery-power operation, the power mode changes as follows: 
<b>Power Conservation Functions for Battery Power</b>		
Standby mode 	<b>Fn</b> + <b>F3</b>	The computer enters standby mode. For more information about this mode → Online book
Suspend mode 	<b>Fn</b> + <b>F4</b>	The computer enters suspend mode. For more information about this mode → Online book
Hibernation mode 	<b>Fn</b> + <b>F12</b>	The computer enters hibernation mode. For more information about this mode → Online book
<b>Other Functions</b>		
Switching between the LCD and the external monitor 	<b>Fn</b> + <b>F7</b>	Computer output is displayed in the following order when an external monitor is attached. 

## Distinctive Functions of Your Computer

Feature and icon	Key Combination	Meaning
Volume up 	<b>Fn</b> + <b>PgUp</b>	Increase the volume.
Volume down 	<b>Fn</b> + <b>PgDn</b>	Decrease the volume.
Mute 	<b>Fn</b> + <b>BackSpace</b>	Turn off sound. <b>Note:</b> To turn on the the sound, press <b>Fn + PgUp</b> or <b>Fn + PgDn</b> .

### Numeric Keypad

The keyboard has some keys that, when enabled, work as if they were on a 10-key numeric keypad. (The numeric keypad on the keyboard is not active when the external keyboard or the external numeric keypad is attached to the computer.)

To enable or disable the numeric keypad, press and hold **Shift** and then press **NumLk**.

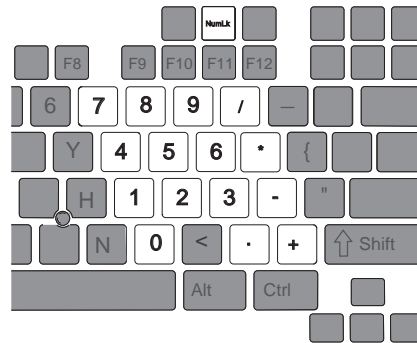

## ***Distinctive Functions of Your Computer***

If the numeric keypad is enabled, press and hold **Shift** to temporarily use the cursor- and screen-control keys.

**Note:**

The functions of the cursor- and screen-control keys are not printed on the keys.

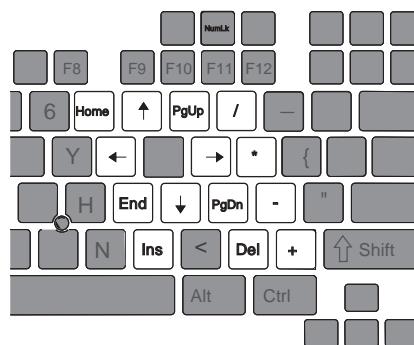



## UltralimBay

Your ThinkPad 600 computer has an UltralimBay.

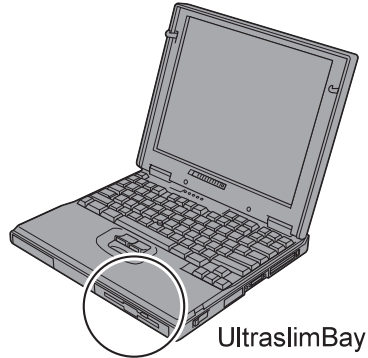

You can install the following drives or bezel in the UltralimBay

Diskette drive

CD-ROM drive

Weight-saver bezel

**Notes:**

1. You can put the diskette drive in a separate enclosure and attach it externally to your computer through the external diskette-drive connector. Then you can use both the CD-ROM drive and the diskette drive at the same time.
2. If your ThinkPad computer is not a CD-ROM model, you can buy the CD-ROM drive as an option.

For how to replace the UltralimBay device → "Replacing the UltralimBay Device" on page 57 .

## Distinctive Functions of Your Computer

### ThinkPad Utility Programs

Your ThinkPad computer has the following utility programs for easy configuration:

- Easy-Setup
- ThinkPad Configuration program

This section summarizes these utility programs.

#### Easy-Setup

Your computer provides a user-friendly program called *Easy-Setup*, which allows you to select various setup parameters:

- Config:** Set the configuration of your computer.
- Date/Time:** Set date and time.
- Password:** Set a password.
- Start up:** Set the startup device.
- Test:** Test the system.
- Restart:** Restart the system.

To start the Easy-Setup, do as follows:

- 1 Turn off the computer, and remove any diskette from the diskette drive.
- 2 Press and hold **F1**; then turn on the computer. Hold **F1** until the "Easy-Setup" menu appears:

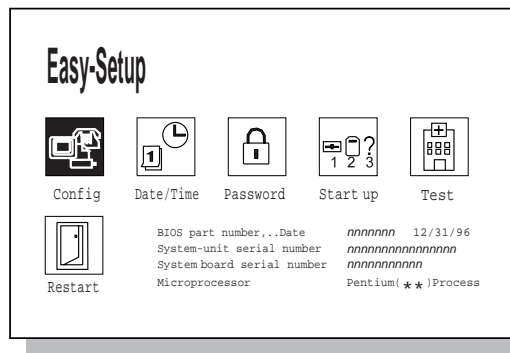

- 3 Move to an icon you want to change, using the arrow keys or the TrackPoint, and click on the icon.

## Distinctive Functions of Your Computer

A submenu is displayed.

**4** Change the items you wish to change.

**5** Click on **Exit** to exit from the submenu.

**6** Click on **Restart** to exit from the “Easy-Setup” menu.

Your computer restarts.

### Changing the Screen Color

You can change the color of the “Easy-Setup” menu by pressing the **Ctrl+PgUp** keys or by pressing the **Ctrl+PgDn** keys.

To return to the original color, press the **Ctrl+Home** keys.

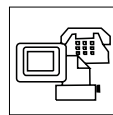

Config

Clicking on the **Config** button displays the following “Config” submenu.

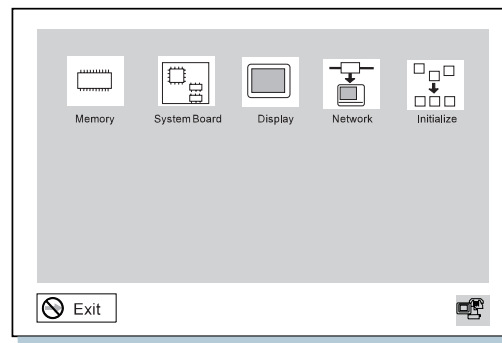

The **Memory** button shows the amount of memory installed and available.



The **System Board** button provides information on the system board installed.



The **Display** button sets the screen output to be displayed on either a **single** screen or on **multiple** screens.



## Distinctive Functions of Your Computer



The **Network** button enables or disables the Wake-On-LAN and Flash-Over-LAN function.



The **Initialize** button sets all device settings to the default values.

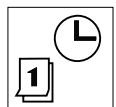

Date/Time

Clicking on the **Date/Time** button displays the following “Date and Time” submenu. It is used to set the current date and time.

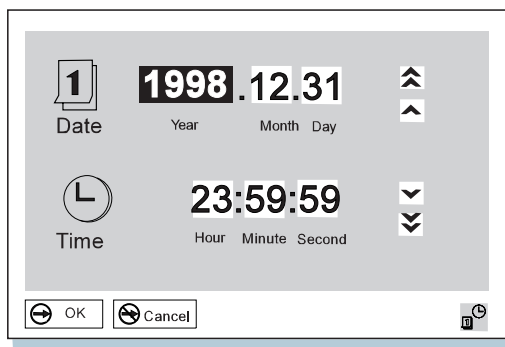

To change the date and time, do the following:

- 1 Move the cursor to any field (Year, Month, Day, Hour, Minute, Second); then type the date and time.

**Note:** Instead of typing, you can place the pointer on any of the arrow icons (⬆, ▲, ▼, or ⬇) to adjust the date and time.

Clicking on the double-arrow icon scrolls the numbers faster.

- 2 Click on **OK** to save the changes or on **Cancel** to cancel them.

**Note:** You can also set the current date and time with the application of the operating system installed in your computer.



## Distinctive Functions of Your Computer



Password

Clicking on the **Password** button displays the “Password” submenu. It is used to set the power-on password, hard disk password, and supervisor password. For more information, go to “Using Passwords” on page 86.

**Note:** An open lock icon shows that a password has not been set yet.

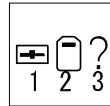

Start up

Clicking on the **Start up** button displays the “Start up” submenu, which you can use to change the startup or boot sequence of the drives in your computer.

For example, if you have different operating systems on different replaceable hard disk drives or PC Cards, you can have the system boot up from one of these devices.

### Attention

You must be extremely careful not to specify a wrong device during a copy, save, or a format operation after you change your startup sequence. If you specify a wrong device, your data and programs might be erased or overwritten.



## ***Distinctive Functions of Your Computer***



To change the startup sequence, do the following:

- 1 Click on **Start up** in the “Easy-Setup” menu. The “Startup” submenu appears:

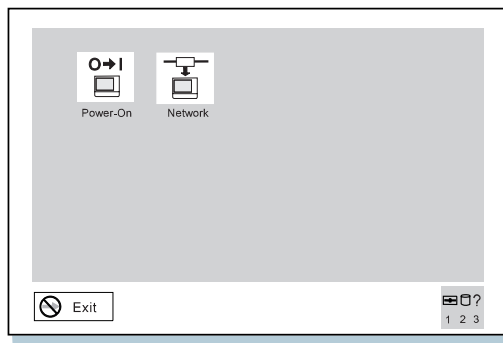

### **Note:**



The **Power-On** button sets the startup sequence when the power switch is set to ON.



The **Network** button sets the startup sequence when Wake-On-LAN is started. Wake-On-LAN is typically used by LAN administrators in corporate networks to access your computer remotely.

For more information on this function, refer to the chapter on “System Management” in the online book.



## Distinctive Functions of Your Computer

### 2 Click on **Power-On** in the submenu.

The “Power-On” submenu appears:

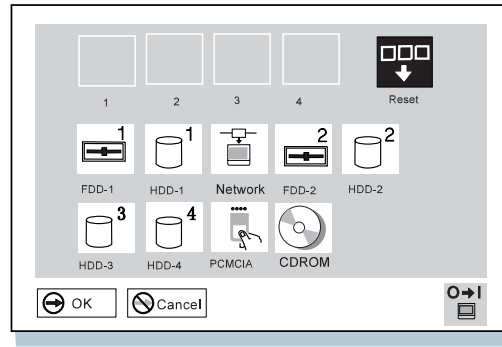

The **FDD-1** icon is the diskette drive in the computer, if you have one. If you don't have a diskette drive in the computer but you have one in the docking station, that diskette drive becomes **FDD-1**. If you have an additional diskette drive, that drive becomes **FDD-2**. See the table at the end of this procedure for details on page 23.

The hard disk drive in your computer is **HDD-1**. A hard disk drive in the docking station is **HDD-2**.

### 3 Move the cursor to the **Reset** icon, and click on it.

### 4 Select the first device you want for the startup sequence; then click on it.

The device moves up to box 1. You cannot set a hard disk drive before a PC Card (PCMCIA).

## ***Distinctive Functions of Your Computer***

If you are using a ***startable CD-ROM***, select **CDROM** as the startup device.

If you are using a ***remote program loading (RPL) system*** through a token-ring card or some other network card, do the following:

**a** Select **Network** and click on it. The “Speed” menu appears.

**b** If you are using a token-ring card, select the speed you want (**4** or **16**), and click on it; then press **Enter**.

If you are using a network card other than a token-ring card, such as an Ethernet card, you need not specify the RPL speed. Press **Esc** to exit this menu.

**5** Repeat these steps for the other devices. You can set up to four devices.

**6** Click on **OK** or press **Enter** to save the changes.



*Distinctive Functions of Your Computer*

**Note:** The following table shows the diskette drives that correspond to FDD-1 or FDD-2:

Case	Diskette Drive in the UltralimBay	Diskette Drive in the Port Replicator	Diskette Drive in the Docking Station	External Diskette Drive
Case 1	<b>FDD-1</b>	None	None	None
Case 2	None	None	None	<b>FDD-1</b>
Case 3	None	<b>FDD-1</b>	None	None
Case 4	None	None	<b>FDD-1</b>	None
Case 5	<b>FDD-1</b>	None	None	<b>FDD-2</b>
Case 6	<b>FDD-1</b>	<b>FDD-2</b>	None	None
Case 7	<b>FDD-1</b>	None	<b>FDD-2</b>	None

**Note:** The external diskette drive, the diskette drive in the port replicator, and the diskette drive in the docking station use a common port. You cannot use more than two diskette drives among the three locations at the same time. You can use the diskette drive in the UltralimBay without any restriction, because the port is independent.

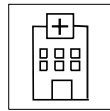

Test

Clicking on the **Test** button displays the “Test” submenu. It is used to run diagnostic tests on your computer to check for hardware errors. For more information, go to “Testing Your Computer” on page 144.

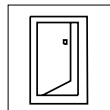

Restart

Clicking on the **Restart** button ends the Easy-Setup program and restarts the computer.

## ***Distinctive Functions of Your Computer***

### ***ThinkPad Configuration Program***

The ThinkPad Configuration program allows you to set up and customize the computer's built-in devices to your needs. For example, you can enable or disable a port, switch between your computer's LCD and an external monitor, and set the power management mode.

This section describes how to start the ThinkPad Configuration program.



#### **For Windows 95:**

To start the **ThinkPad Configuration** program for Windows 95, find the ThinkPad icon on the right side of the taskbar; then double-click on the icon.

**Note:** You can also start the ThinkPad Configuration program as follows:

- 1** Click on **Start**.
- 2** Move the cursor to **Programs** and **ThinkPad**; then click on **ThinkPad Configuration**.

The following window appears:

## Distinctive Functions of Your Computer

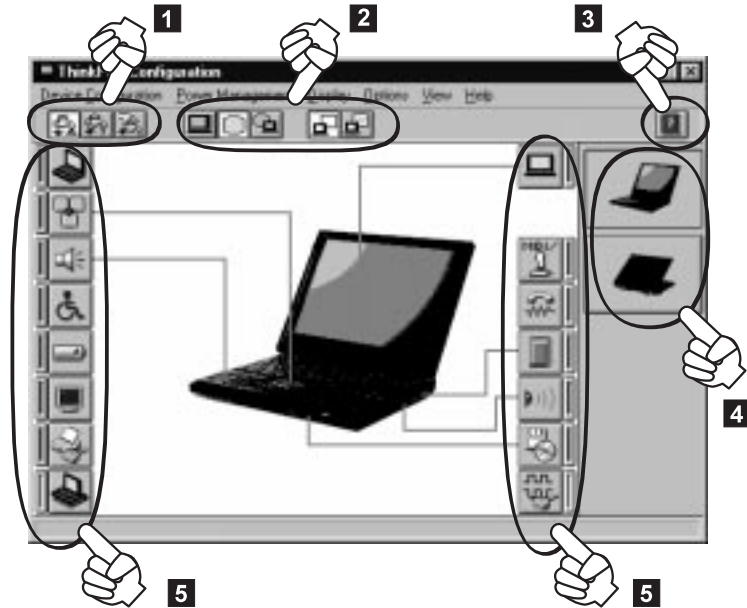

- 1 The **Power Mode** buttons  
Click on one of these buttons to set the power mode to high-performance mode, automatic mode, or customized mode.
- 2 The **Display Device** buttons  
Click on one of these buttons to set the display output type to the LCD, external monitor, or both. If making a presentation, you can click on the presentation button to disable any system timers, such as the LCD turnoff timer or the power management mode timers.
- 3 The **Help** button displays online help.
- 4 The **View Angle** buttons  
Click on the front view or rear view buttons to display the hardware feature locations.
- 5 The **Device** buttons  
Click on the button of your choice from the window. If the device is enabled, the red indicator next to the button is lit. Otherwise, it stays off.



## ***Distinctive Functions of Your Computer***



To start the **ThinkPad Configuration** program for Windows NT, Windows 3.1, or OS/2, do as follows. The ThinkPad Configuration window on the next page appears.



### **For Windows NT:**

- 1** Click on **Start**.
- 2** Move the cursor on **Programs** and **ThinkPad**; then click on **ThinkPad Configuration**.



### **For Windows 3.1:**

Double-click on the **ThinkPad Configuration** icon.



### **For OS/2:**

- 1** Double-click on the **ThinkPad Configuration** folder.
- 2** Double-click on **ThinkPad Configuration**.



## Distinctive Functions of Your Computer

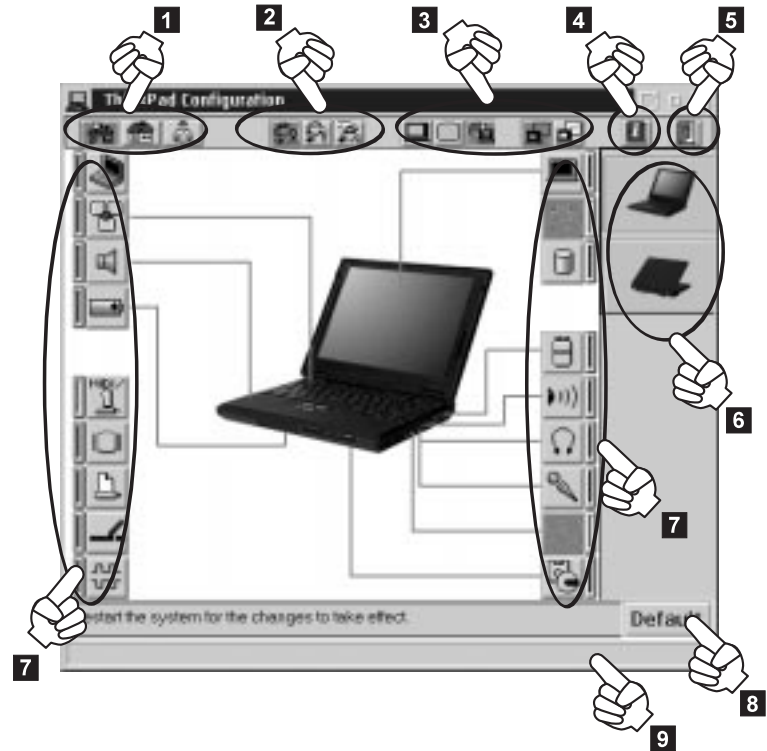

- 1 The **One-Touch Setup** buttons  
Click on one of these buttons to set the system configuration.
- 2 The **Power Mode** buttons  
Click on one of these buttons to set the power mode to high-performance mode, automatic mode, or customized mode.
- 3 The **Display Device** buttons  
Click on one of these buttons to set the display output type to the LCD, external monitor, or both. When making a presentation, you can click on the presentation button to disable any system timers, such as the LCD turnoff timer or the power management mode timers.
- 4 The **Help** button displays online help.
- 5 The **Exit** button  
Click on this button to save the changes made and to exit from the ThinkPad Configuration window.



## ***Distinctive Functions of Your Computer***



- 6 The **View Angle** buttons  
Click on the front view or rear view buttons to display the hardware feature locations.
- 7 The **Device** buttons  
Click on the button of your choice from the window; then set the options for that device from the window that appears. If the device is enabled, the red indicator next to the button is lit. Otherwise, it stays off.
- 8 The **Default** button  
Click on this button to set the default values for each option and to cancel the changes you just made.
- 9 The **Status** bar  
The device name and its status appears in the status bar when you place the cursor on a device button.

Only the top portion of the window is displayed when you click on the triangular minimize button in the top-right corner.



**DOS****For DOS:**

You can use the ThinkPad Configuration program from the DOS prompt. To start the program, do the following:

**1** Click on **Start**; then the **DOS Prompt** icon.

The DOS prompt window appears.

**2** Type **PS2 ?** at the **C:** prompt.

The “ThinkPad Configuration” online help window appears:

```
C:\>PS2 ?
```

```
(C) Copyright IBM Corp. 1993,1998. All rights reserved.  
US Government Users Restricted Rights - Use, duplication  
or disclosure restricted by GSA ADP Schedule Contract  
with IBM Corp.
```

```
Command Syntax: PS2 [Parameter1] [Parameter2] [Parameter3]
```

```
Following are available [Parameter1].  
For the complete command syntax,  
type 'PS2 ? [Parameter]'.
```

```
1.Power Management related
```

## *Distinctive Functions of Your Computer*

- 3** Select an item from the menu and follow the instructions on the screen to set the features.

You can also create a batch file (\*.BAT) like the one shown to match your operating environment. The following sample batch file sets a longer battery operating time.

```
@Echo Off

Rem SAMPLE:Set the parameters to provide maximum power utilization.

Rem =====

PS2 PMode Custom DC           > Nul
PS2 Lcd 3                     > Nul
PS2 DISK 3                    > Nul
PS2 POver 5                   > Nul
PS2 SSpeed Fixed Slow        > Nul
PS2 IR Disable                > Nul
PS2 SSerial OFF               > Nul
```



## Online Book

Your ThinkPad computer features an online book, so that you will always have key information at your fingertips even if you are traveling. It contains the following information:

### Basic:

- Using your computer outside your country
- Using the audio, infrared, and modem features
- Using your computer with a battery pack
- Using your computer with a PC Card

### Advanced:

- Installing software
- Using system management

### Trouble:

- Resolving system resource conflicts
- Solving computer problems

To start the online book, click on **Start**, move the cursor to **Programs** and **ThinkPad 600**; then click on **ThinkPad 600 User's Guide**.

The online book appears. Go to the section you want, and make a printout if necessary.

**Note:** You can start the online book from the ThinkPad Customization CD as follows:

1. From the ThinkPad Customization Center main menu, click on **Online Library**.
2. Click on **Click here to launch the online User's Guide**.

## ***Backing Up Your System***

# **Backing Up Your System**

To back up your system or reinstall the operating system, your ThinkPad computer has the following features.

**Note:** These features are for Windows 95 and Windows NT. If you are using a different operating system, get the hardware device driver from the ThinkPad Web site (see "ThinkPad Web Site or Bulletin Board" on the next page).

- The ThinkPad Customization CD
- The Recovery CD
- The Diskette Factory program
- ConfigSafe
- ThinkPad Web site or bulletin board

For more information about recovering lost or damaged software → "Recovering Lost or Damaged Software" on page 147 .

## **ThinkPad Customization CD**

You can customize your system using this CD. It contains all the software applications and hardware device drivers for your computer in the Windows 95 or Windows NT environment. It features the ThinkPad Customization Center, which protects your data. (To use the ThinkPad Customization CD → "Using the ThinkPad Customization CD" on page 149 .)

## **Recovery CD**

If you accidentally erase your hard disk, you can use the Recovery CD to restore the contents of the preinstalled hard disk to what it was at the time of purchase. (To use the Recovery CD → "Using the Recovery CD" on page 150 .)

## **Diskette Factory**

The Diskette Factory program contains all the hardware device drivers for your computer in the Windows 95 and Windows NT environment.

Also, you can recover a device driver if you do not have a CD-ROM drive and cannot use the ThinkPad Customization CD. With this program, you can create the utility and device driver diskettes for Windows 95 or Windows NT. (To use the Diskette Factory → “Using the Diskette Factory” on page 148 .)

For more information about installing a new operating system and device drivers → “Advanced” in the online book.

## ConfigSafe

ConfigSafe is an application program for Windows 95 or Windows NT that periodically takes *snapshots* of your system files. If your computer does not operate properly after you install a new device driver or software, use ConfigSafe to restore the last working version of your system files. Although it might not make your new hardware or software work, it will set your computer. This application protects your data.

## ThinkPad Web Site or Bulletin Board

IBM supplies all of the latest hardware device drivers and system BIOS for your computer on the ThinkPad Web site:  
**<http://www.pc.ibm.com/thinkpad>**

You can also use the IBM bulletin board service.

For more information about electronic service and support → Chapter 5, “Getting Service” on page 153 .

For Web browser links to the IBM Web site → “Find Information” in the online book.



## Replacing the Battery Pack



# Replacing the Battery Pack

To replace the battery pack, do as follows:

- 1** Power off your computer.
- 2** Disconnect the AC Adapter and cables.
- 3** Close the LCD and turn the computer over.
- 4** Slide the battery pack latch to unlocked position **1** ; then remove the battery pack **2** .

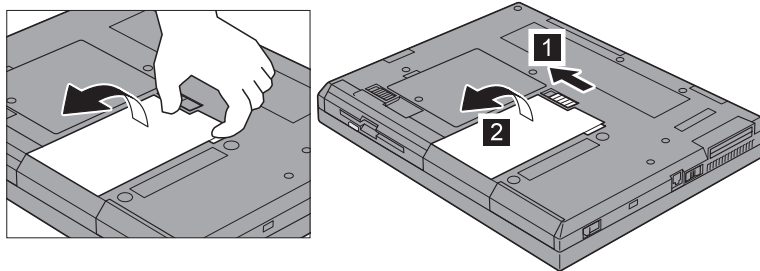

- 5** To install the new battery pack, align the front of the battery pack with the front side of the battery space in the computer **1** ; then put the battery pack in place **2** .

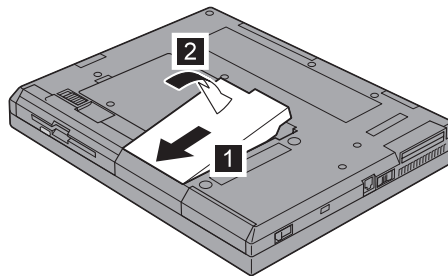

## Replacing the Battery Pack

- 6** Gently push the battery pack back into the space; then slide the battery pack latch to the locked position.

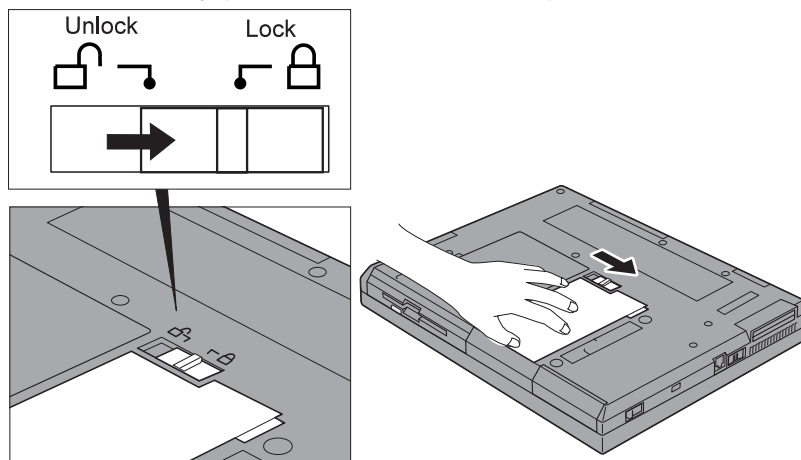

You have finished replacing the battery pack.

**Note:** You can replace the battery when the computer is in hibernation mode or when it is powered off. If you are using a PC Card, the computer might not be able to enter hibernation mode. If this happens, power off the computer.

## Handling Your Computer

# Handling Your Computer

By using common sense and by following these handling tips, you will get the most use and enjoyment out of your ThinkPad computer for a long time to come.

Notebook computers are precision machines that require a bit of careful handling. Though the IBM ThinkPad computer is designed and tested to be a durable notebook computer that functions reliably in normal work environments, you need to use some common sense in handling it.

### Note

If you power off the computer, wait at least 5 seconds before you power it on again.

## ThinkPad Don'ts

Do not subject your computer to physical punishment, such as dropping or bumping.

Do not place heavy objects on your computer.

Do not spill liquids into your computer.

Do not use your computer in or near water (to avoid the danger of electrical shock).

Do not pack your computer in a tightly packed suitcase or bag. The compression might cause internal damage.

Do not disassemble your computer. Only an authorized IBM ThinkPad repair technician should disassemble and repair your computer.

Do not scratch, twist, hit, or push the surface of your computer display.

Do not place any objects between the display and keyboard.

Do not pick up or hold your computer by the display. When picking up your open computer, hold it by the bottom (keyboard) half.

Do not modify or tape the latches to keep the display open or closed.

Do not turn your computer over while the AC Adapter is plugged in. This could break the adapter plug.

Do not use or store your computer where the temperature is below 5° C or above 35° C (41° F and 95° F).

Do not place your computer closer than 13 cm (5 in.) from any electrical appliance that generates a strong magnetic field, such as a motor, a magnet, a TV, a refrigerator, or large audio speakers.

Do not hard-mount your computer in a vehicle or anywhere that it is subject to strong vibration. See "Ruggedized Mobile Computers" on page 40 for information on a more appropriate model for demanding applications.

Do not crush or drop the external or removable hard disk, diskette, or CD-ROM drive when it is outside your computer.

Do not press on the middle part of the diskette drive or CD-ROM drive.

Do not insert a diskette at an angle. Not inserting the diskette straight into the drive can damage the drive.

Do not place more than one label on a diskette. Multiple or loose labels can detach or tear and then lodge in the drive.

Do not touch the lens on the CD-ROM tray.

Do not touch the surface of a compact disc; handle the compact disc only by its edges.

Do not connect the modem to a PBX (private branch exchange) or other digital telephone extension line. **Your computer can use only a public-switched telephone network (PSTN).** Use of a phone line other than PSTN can damage your modem. If you are not sure which kind of phone line you are using, contact your telephone company. Many hotels or office buildings use digital telephone extension lines, so check before connecting the telephone cable in such places.

Do not leave the base of your computer in contact with your lap or any part of your body for an extended period when the computer is functioning or when the battery is charging. Your computer dissipates some heat during normal operation. This heat is a function of the level of system activity and battery charge level.

## ThinkPad Do's

Store your CD-ROM drive in the CD carrying case and the diskette drive in its enclosure.

## Handling Your Computer

When installing your hard disk, diskette, or CD-ROM drive, follow the instructions in this book and apply pressure only where needed on the device.

Treat your computer like a precision piece of electronic machinery.

Retain and store packing materials safely out of reach of children to prevent the risk of suffocation from plastic bags.

Register your ThinkPad products with IBM (refer to the *Setup Guide*). This can help authorities return your computer to you if it is lost or stolen. Registering your computer also enables IBM to notify you about possible upgrades.

Check the IBM Web pages at [www.pc.ibm.com](http://www.pc.ibm.com) periodically to get current information about your computer.

## Cleaning Your Computer

Occasionally clean your computer as follows:

Use a soft cloth moistened with nonalkaline detergent to wipe the exterior of the computer.

Don't spray cleaner directly on the display or keyboard.

Gently wipe the LCD with a dry, soft cloth.

## Carrying Your Computer

When carrying your computer, follow these instructions to prevent possible damage to your computer and data:

- 1** Remove any media from the CD-ROM drive or diskette drive.
- 2** Turn off all attached devices.
- 3** Turn off the computer and close the LCD.
- 4** Unplug all external cables and cords connected to your computer.
- 5** Make sure all computer doors and covers are closed.
- 6** Use a quality carrying case that provides adequate cushion and protection.



## Extending Your Computer's Battery Life

The amount of battery power consumed by your computer depends on such conditions as the usage frequency, the operating temperature, and the period in storage (if unused). The following tips can help you to extend the life of your battery:

If your battery is brand new and you are charging it for the first time, it might not become fully charged due to the characteristics of the chemicals in the cell. To maximize performance, ensure that all chemicals in the battery are fully activated by cycling the battery (fully charge, then fully discharge) three times. Also, follow this procedure if you stored the battery for a few months.

Do not charge the battery pack until all of its power is used. Recharging a battery pack that is not completely discharged can shorten battery life.

Once you start charging the battery pack, do not use it until it is fully charged.

Whenever possible, use the ThinkPad battery power-saving modes:

- **Standby:** The LCD and the hard disk drive are turned off.
- **Suspend:** All tasks are stopped and stored in memory to save power.
- **Hibernation:** All tasks are stopped. The memory data and the current status of the computer are stored on the hard disk; then the power is turned off.

Decrease the LCD brightness.

Use Advanced Power Management (APM). Each operating system comes with its own APM.

Stop the supply of power to the internal serial devices, including the modem, the serial port, and the infrared port, if they are not in use.

Remove the battery pack and keep it in a cool place if you will not be using the computer for a long period.

## ***Handling Your Computer***

### **Ruggedized Mobile Computers**

Some professionals work in environments that may require special ruggedized features to protect their computers from extreme temperature, humidity, and physical punishment. Construction, public service, distribution, repair service, and utilities are some of the environmentally demanding professions that may require rugged mobile computers that can withstand stresses. For these applications, IBM offers such computers (not Thinkpad systems), especially designed for mobile professionals who need a system for managing and communicating information from the field.

For more information on these computers, consult your IBM Business Partner or visit our Web site at:

**[www.networking.ibm.com/wireless](http://www.networking.ibm.com/wireless)**.

### **Ergonomics Information**

This is important information you should read before using your portable ThinkPad notebook computer in your “virtual office.”

Working in the virtual office might mean adapting to frequent changes in your environment. Following some simple “rules of the road” will make things easier and bring you the maximum benefits of your ThinkPad computer. Keeping in mind such basics as good lighting and proper seating, for example, can go a long way in helping you enhance your performance and achieve greater comfort wherever you are.

#### ***What if you are traveling?***

It may not be possible to observe the best ergonomics practices when you are using your ThinkPad computer while on the move or in a “casual” setting. Regardless of the setting, try to observe as many of the tips for proper usage as possible. Sitting properly and using adequate lighting, for example, will help you maintain desirable comfort and performance levels.

#### ***Questions about vision?***

IBM's visual display screens are designed to meet the highest standards and to provide you with clear, crisp images and large, bright displays that are easy to see, yet easy on the eyes. Of

## Handling Your Computer

course, any concentrated and sustained visual activity can be tiring. If you have questions on eye fatigue or visual discomfort, consult a vision care specialist for advice.

**Note:** The example shown here is of someone in a traditional setting. Even when not in such a setting, you can follow many of these tips. Develop good habits, and they will serve you well.

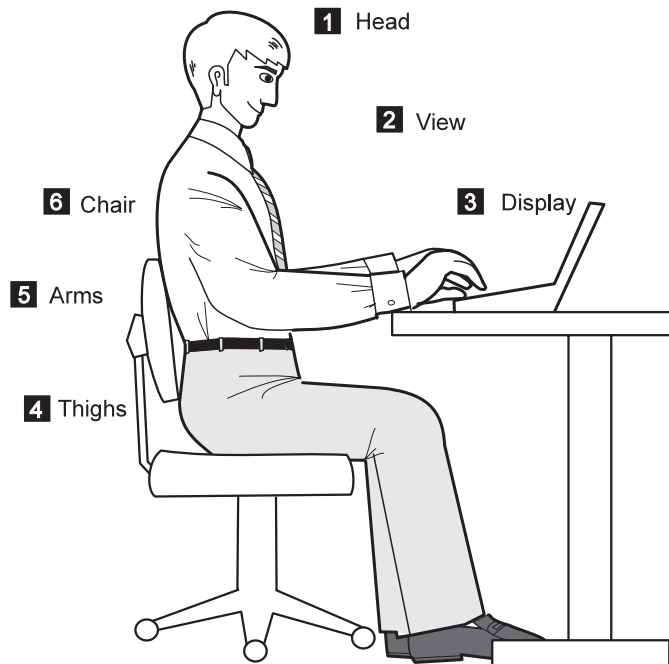

## Handling Your Computer

- 1 **Head**  
Keep your head in a comfortable and vertical position.
- 2 **View**  
Maintain a comfortable viewing distance of 510–760 mm (20–30 in.).
- 3 **Display**  
Position the display to avoid glare or reflections from overhead lighting or outside sources of light.  
  
Keep the display screen clean and set the contrast and brightness to levels that allow you to see the screen clearly.
- 4 **Thighs**  
Keep your thighs parallel to the floor and your feet flat on the floor or on a footrest.
- 5 **Arms**  
Keep your forearms, wrists, and hands in a relaxed and neutral position. Don't pound the keys; type with a soft touch.
- 6 **Chair**  
Use a chair that gives you good back support.

## For More Information

For information from the World Wide Web	<a href="http://www.pc.ibm.com/us">www.pc.ibm.com/us</a> <a href="http://www.networking.ibm.com/wireless">www.networking.ibm.com/wireless</a>
For product and dealer location information	1 800 426-2968
To access the IBM PC Company Bulletin Board	1 919 517-0001
For product information sent directly to your fax machine	1 800 IBM-3395 (1 800 426-3395)
IBM PC Product Guide Directory	Select FaxDoc #12745 (to specific product sections)
IBM ThinkPad Information Directory	Select FaxDoc #11078



## Chapter 2. Extending the Features of Your Computer



This chapter provides information about how to customize and extend the ThinkPad features. You can use your computer with external devices and increase its memory.

Customizing the TrackPoint . . . . .	44
Increasing Memory . . . . .	49
Upgrading the Hard Disk Drive . . . . .	55
Replacing the UltralimBay Device . . . . .	57
Attaching the Diskette Drive Externally . . . . .	61
Removing the Diskette Drive from the Enclosure . . . . .	62
Attaching an External Mouse, Keypad, and Keyboard . . . . .	63
Attaching an External Mouse or Numeric Keypad . . . . .	63
Attaching an External Keyboard and Mouse . . . . .	64
Disabling the TrackPoint . . . . .	66
Attaching an External Monitor . . . . .	67
Display Output Location . . . . .	68
Display Modes . . . . .	70
Inserting a PC Card . . . . .	72
Installing the PC Card Driver . . . . .	74
Removing the PC Card . . . . .	75
Using a Docking Station . . . . .	76
Docking with Your Computer Powered Off (Cold Docking) . . . . .	77
Undocking When Your Computer is Powered On or in Suspend Mode (Hot or Warm Undocking) . . . . .	79
Presetting a Device to Avoid a Resource Conflict . . . . .	80
Enabling the IDE Drive on the Docking Station . . . . .	81





## Customizing the TrackPoint



# Customizing the TrackPoint

You can customize the TrackPoint by doing the following:

- 1 Open the ThinkPad Configuration program.
- 2 Click on the **TrackPoint** button ()
- 3 Click on **Properties...**

The "TrackPoint Properties" window appears:

You can set the following features in this window:

- Press-to-Select
- Sensitivity
- Scrolling or Magnifying Glass

## Using the Press-to-Select Page



If you enable Press-to-Select by putting a check mark in the **Enable Press-to-Select** box, you can make the TrackPoint stick function the same as the left or right click button on the keyboard.



## *Customizing the TrackPoint*

If you check **Enable dragging**, you can drag the icon that you select with the TrackPoint stick by putting light pressure on the stick.

If you check **Enable Release-to-Select**, you can click simply by lifting your finger quickly off the TrackPoint. Moving the cursor onto an icon and then lifting your finger off the TrackPoint works like clicking. Pressing the TrackPoint again works like double-clicking.

Click on one of the **Press means** radio buttons to select which button the stick will simulate: either the left or the right button. For example, if you select **Left Click**, you can start a program with the TrackPoint by putting the pointer on the program's icon and applying light pressure on the stick.

To adjust the pressing timing of the stick, set **Click Pace**.

**Note:** If you set the pace too slow, you might notice unintended clicks, a pointer delay, or a dragging delay. However, if you set the pace too fast, you might find Press-to-Select hard to use.



## Customizing the TrackPoint



### Using the Sensitivity Page

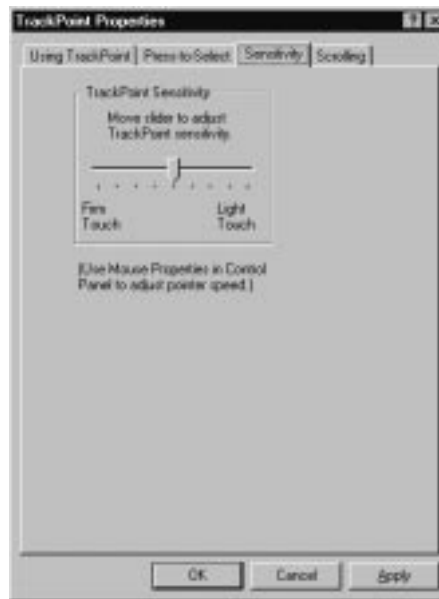

This function adjusts the force required for both cursor movement and Press-to-Select. Slide toward **Firm Touch** to increase the force needed to move the pointer and to activate Press-to-Select. Slide toward **Light Touch** to decrease the force needed to move the pointer and to activate Press-to-Select.





## Using the Scrolling Page



By clicking on the **Scrolling** tab, you can set the scrolling properties of your TrackPoint.

### **Choose Scrolling or the Magnifying Glass Function**

Select one of the following radio buttons.

- **Scrolling**

This function enables you to navigate easily through long documents or large spreadsheets with the press of a button. To scroll, press the center button and then use the TrackPoint instead of the scroll bars in any program.

- **Magnifying Glass**

This function enables you to enlarge a movable area of your display. You can click on objects “through” the magnifying glass. The right button changes the size of the magnifying glass, and the left mouse button changes its magnifying power. Move the magnified area the same way as you use the scrolling function; in other words, press the center button and then use the TrackPoint to move the magnified area.

## Customizing the TrackPoint

- **Neither**

This function disables the scrolling and magnifying glass functions.

### Choose Scrolling Method

Select one of the following radio buttons.

- **Press Center Button, then use TrackPoint**

Holding down the center button on the keyboard allows the TrackPoint to control the scrolling or the magnifying glass. The TrackPoint operates normally (controls the mouse cursor) when the center button is not pressed.

- **Use External Mouse**

This option sets an externally attached mouse to scroll (or move the magnifying glass) horizontally or vertically. Use the TrackPoint as a pointer.

- **Use TrackPoint**

This option sets the TrackPoint to scroll horizontally or vertically. Use an externally attached mouse as a pointer. Use the setting if you have a mouse attached.

You can still use the TrackPoint to control the mouse pointer by pressing the center button.

**Note:** The **Use External Mouse** and the **Use TrackPoint** radio buttons are enabled only if a mouse is attached.

## Increasing Memory

Increasing memory capacity is an effective way to make programs run faster. You can increase the amount of memory in your computer by installing a dual inline memory module (DIMM), available as an option.

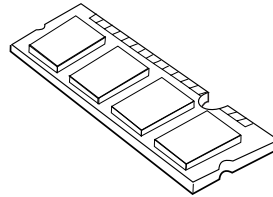

Different capacities of DIMM are available. You can install a DIMM directly in the memory slot on the bottom of the computer. Your computer memory capacity can be expanded up to 160 MB (32 MB base memory and two 64 MB DIMM options).

### Attention

The ThinkPad 600 computer supports the static dynamic random access memory (SDRAM) card only. It does not support the enhanced data output dynamic random access memory (EDO DRAM) card. If you install a DIMM that is not supported by your computer, a 225 error code might appear when the system starts. The appropriate memory option can be purchased through your IBM reseller or IBM marketing representative.

To install the DIMM, do the following:

- 1** Power off the computer; then disconnect the AC Adapter and all cables from the computer.
- 2** Close the LCD, turn the computer over again and then remove the battery pack.



## Increasing Memory



- 3 Loosen the screw on the memory slot cover; then remove the cover.

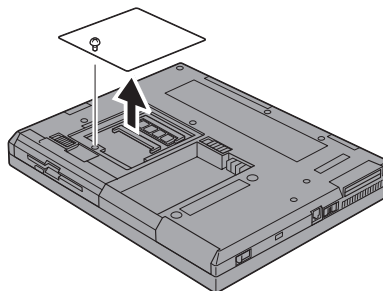

- 4 Install the DIMM into the memory slot.

**Attention**

To avoid damaging the DIMM, do not touch its contact edge.

- a Find the notch on the side of the DIMM.
  - b With the notched end of the DIMM toward the right side of the socket, insert the DIMM, at an angle of approximately 20°, into the socket; then press it firmly 1 .
  - c Pivot the DIMM until it snaps into place 2 .
- If you want to install two DIMMs, repeat these steps.



## Increasing Memory

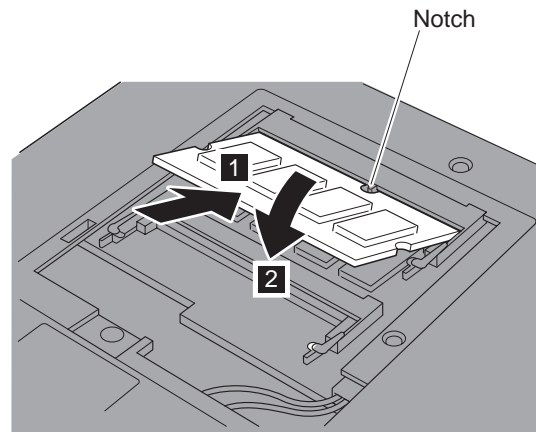

Side view

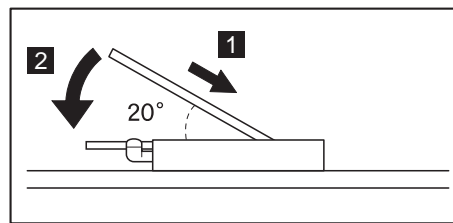

- 5 Replace the memory slot cover over the memory slot, aligning the back side of the cover first as shown; then tighten the screw.

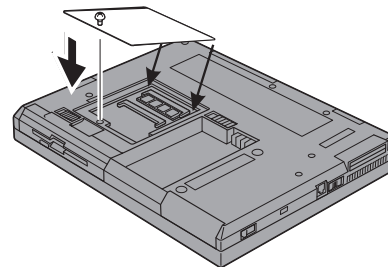

## Increasing Memory

**6** Replace the battery pack.

**7** Turn the computer over again, power on the computer; then confirm that the new memory size appears at the upper left corner of the screen.

For example, if you install the 32-MB DIMM you should see the following: See the next page for how to calculate the total memory size.

```
6496 KB OK
```

You have finished installing the DIMM. Reconnect all cables.

### Notes:

1. For the following status, power off the computer and go to page 50 to reinstall the DIMM and do the memory test with Easy-Setup (see "Testing Your Computer" on page 144).

If a 2 1 error code appears under the memory count.

```
48576 KB OK  
2 1
```

If the total memory size is not the same as the value you calculated.

If the 225 error code appears, the memory you are installing is not supported by your computer.

2. If you changed the memory installed in the computer, you need to create a new hibernation file. To create the hibernation file → "Basic" in the online book.

### **How to Calculate Total Memory Size**

Calculate your total memory size in kilobytes (KB) by adding the DIMM memory size to the base memory size (32192 KB).

**Note:** 576 KB is reserved by the system.

For example, if you installed a 32 MB DIMM, you should have about 64 MB. If you installed two 32 MB DIMMs, you should have about 96 MB.

Your computer might display memory size in kilobytes. For example, 64 MB=64960 KB.

## Increasing Memory

### Removing the DIMM

1. Power off the computer and disconnect the AC Adapter and all cables from the computer.
2. Close the LCD, turn the computer over, and then remove the battery pack.
3. Loosen the screw and remove the memory slot cover.
4. Press out on the latches on both edges of the socket at the same time.

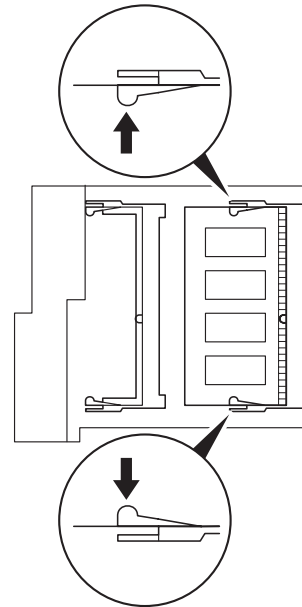

5. Remove the DIMM.  
Be sure to save the DIMM for future use.
6. Replace the memory slot cover; then tighten the screw.
7. Replace the battery pack.
8. Turn the computer over again; then connect the AC Adapter and all the cables you disconnected.



## Upgrading the Hard Disk Drive

You can increase the storage capacity of your computer by replacing the original, built-in hard disk drive with an optional one. You can purchase the option from your IBM reseller or IBM marketing representative.

**Note:** Replace the hard disk drive only if you upgrade it or have it repaired. You should not replace it often.

### Attention

**Do not drop or apply any shock to the hard disk drive.** The drive is sensitive to physical shock. Incorrect handling can cause damage and permanent loss of data on the hard disk. Before removing the hard disk drive, make a backup copy of all the information on the hard disk. Never remove the drive while the system is operating or in suspend mode.

To replace the hard disk drive, do the following:

- 1** Power off the computer; then disconnect the AC Adapter and all cables from the computer, and turn the computer upside down.
- 2** Remove the coin screw by rotating it counterclockwise with a coin, as shown 1; then remove the hard disk drive cover 2.

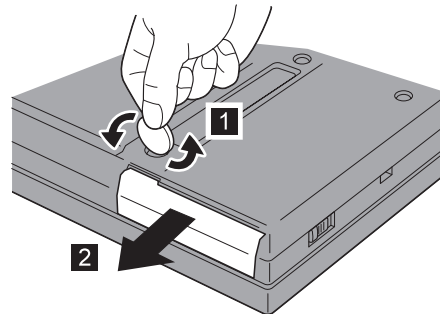

**Note:** You can replace the coin screw with the security screw shipped with your computer. With the security screw installed, the hard disk drive in your computer cannot be



## Upgrading the Hard Disk Drive



removed easily. To remove or tighten the security screw, use a 2.5-mm Allen wrench.

### 3 Pull the strap of the hard disk drive to remove the drive.

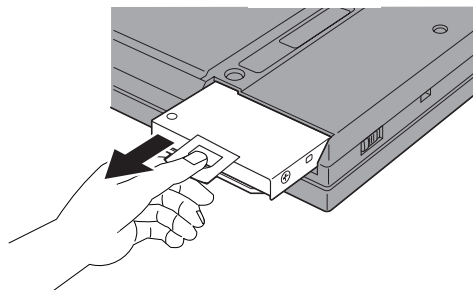

### 4 To install the new hard disk drive, do the following:

**Note:** If the hard disk drive that you will be installing has spacer on it, remove the spacer using something like a small screwdriver.

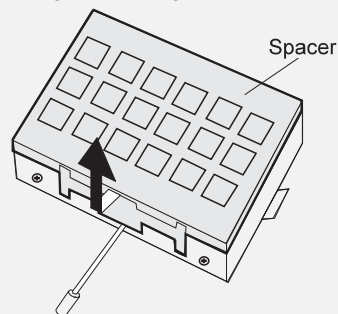

- a** Insert the new hard disk drive into the bay. Make sure you connect the drive firmly.
- b** Replace the hard disk drive cover, and reinstall the screw.
- c** Turn the computer right-side up, and power it on.



## Replacing the UltralimBay Device

You can install the following drives or bezel in the UltralimBay

Diskette drive

CD-ROM drive

Weight-saver bezel

### Warm Swap

Warm swap means to remove or reconnect a device when the computer is in suspend mode.

The diskette drive is a warm-swappable device in the UltralimBay as a default at the time of shipping, but you can change this setting by changing the configuration.

If you restart or turn on the computer with the diskette drive attached to the external diskette-drive connector, the diskette drive is recognized as a warm swappable device on the external diskette-drive connector.

You can always warm-swap the diskette drive to the same port that it was connected to when the computer was restarted or turned on.

**Note:** You can also change this setting with the ThinkPad Configuration program.

The diskette drive is not supported as a warm-swappable device *between* the UltralimBay and the external diskette-drive connector. To remove the diskette drive from the UltralimBay and attach it to the external diskette-drive connector or vice versa, you need to first turn off the computer.

## Replacing the UltralimBay Device

Warm swap is enabled as a default. To check whether warm swap is enabled, do as follows:

- 1** Start the ThinkPad Configuration program.  
See "ThinkPad Configuration Program" on page 24.
- 2** Click on **UltraBay** (  ).
- 3** Make sure that there is a check mark in the **Enable IDE device Hot/Warm Swap** check box.  
If there is no check mark, add a check mark in the box and restart your computer to make the change effective.

### Attention

Make sure that the bay LED is off. Never remove the UltralimBay device when the bay LED is on.

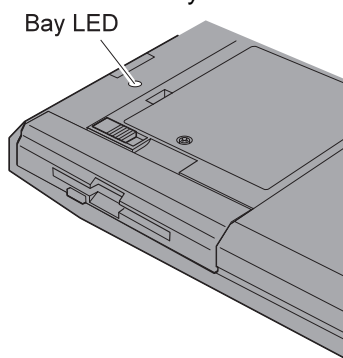

(Bottom view)

## Replacing the UltralimBay Device

The following table shows what you do if you want to replace the device in the UltralimBay or attach the diskette externally:

If the computer power is on and...	You want to...	You need to...
The CD-ROM drive is in the UltralimBay	install the diskette drive in the bay	enter your computer suspend mode or power off your computer; then swap the device.
	attach the diskette drive externally	power off your computer; then attach the diskette drive.
The diskette drive is in the UltralimBay	install the CD-ROM drive in the bay	enter your computer suspend mode or power off your computer; then swap the device.
	install the CD-ROM drive in the bay and attach the diskette drive externally	power off your computer; then swap and attach the devices.

If you install the CD-ROM drive in the UltralimBay, you can connect the diskette drive to the external diskette-drive connector and use it as an external diskette drive.

This procedure describes how to replace the diskette drive with the CD-ROM drive; follow the same procedure if you install the diskette drive or weight-saver bezel in the UltralimBay.

- 1** Power off the computer, and remove the AC adapter and cables; then turn the computer upside down.

## Replacing the UltralimBay Device

- 2 With releasing the UltralimBay device lock to the unlocked position 1 ; then remove the diskette drive 2 .

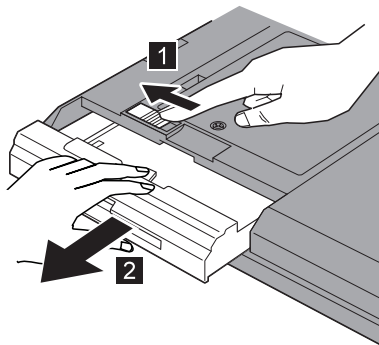

- 3 Insert the CD-ROM drive.

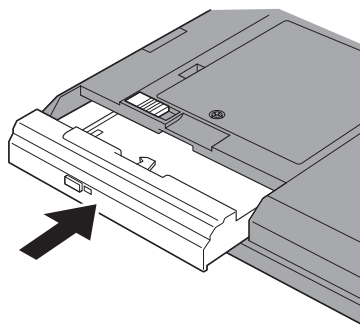

## Attaching the Diskette Drive Externally

Your ThinkPad computer might have been shipped with an external diskette drive enclosure. Using this enclosure, you can attach the internal diskette drive externally. To attach the internal diskette drive externally, do the following:

- 1** Insert the diskette drive in the enclosure and connect it firmly.

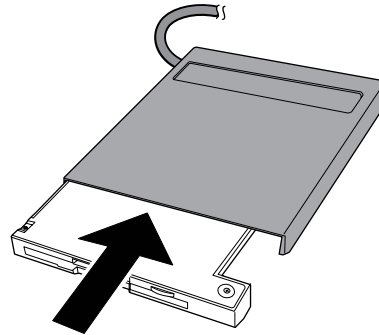

- 2** Connect the cable to the external diskette-drive connector.

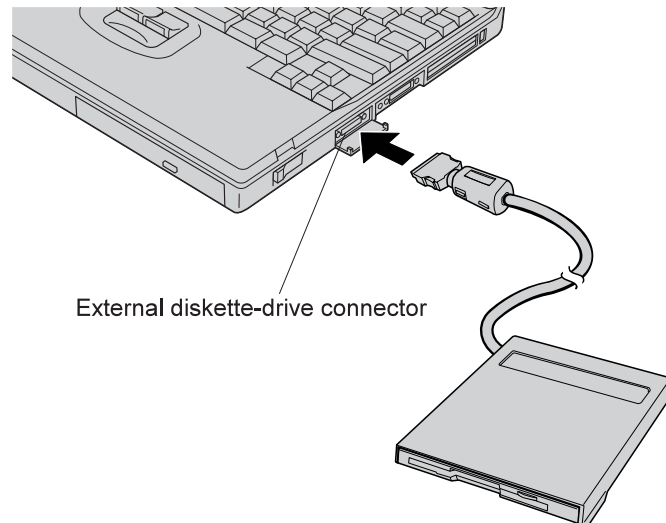



## ***Attaching the Diskette Drive Externally***



### **Removing the Diskette Drive from the Enclosure**

The diskette drive enclosure has a lock on the bottom. To remove the diskette drive from the enclosure, hold the lock in the unlocked position and remove the drive.

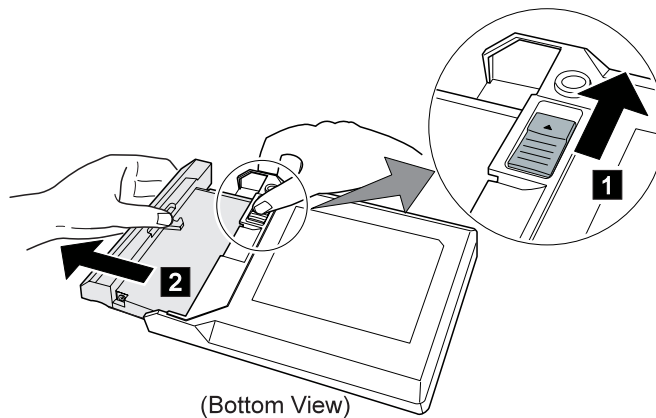



## Attaching an External Mouse, Keypad, and Keyboard

This section explains how to attach an external mouse, external numeric keypad, and external keyboard to your computer.

### Attaching an External Mouse or Numeric Keypad

You can attach an external mouse or numeric keypad to the external-input-device connector (  ) on the rear of the computer.

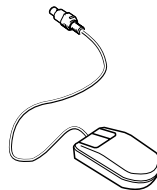

Mouse



External keypad

If you want to attach the mouse, attach it directly to the external-input-device connector as shown:

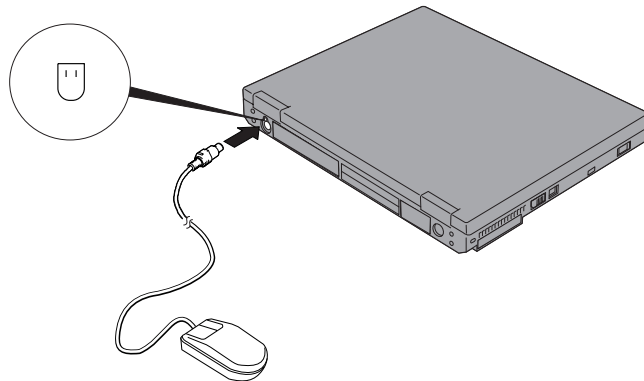

#### Attention

You can use both the IBM PS/2 Miniature Mouse and TrackPoint as an input device. If you are connecting a mouse other than an IBM PS/2 Miniature Mouse, turn off the computer. Then go to “Disabling the TrackPoint” on page 66.

## Attaching External Mouse, Keypad, and Keyboard

If you want to use both the external numeric keypad and mouse at the same time, first connect the keypad cable to the computer; then connect the mouse cable 1 to the connector at the rear of the keypad.

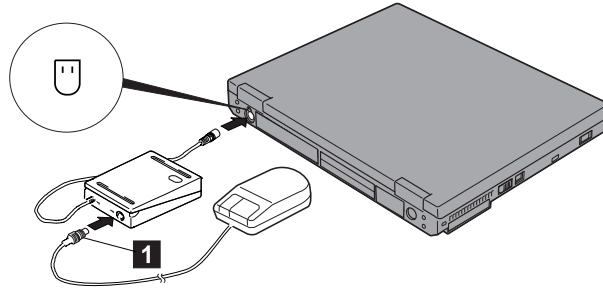

**Note:** You can remove the keypad cover and use it as a stand for the keypad.

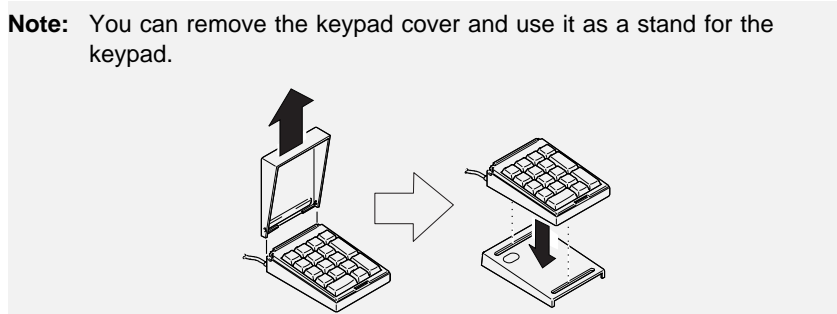

## Attaching an External Keyboard and Mouse



Mouse

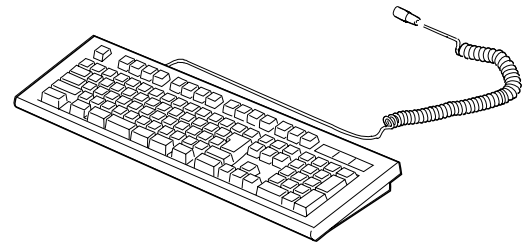

External keyboard

You can connect an external keyboard to your computer through the keyboard/mouse cable (available separately as an option). **The external keyboard will not work if it is connected directly to the computer.**

## Attaching External Mouse, Keypad, and Keyboard

When the external keyboard is attached, the following keys are not available:

- Numeric keypad on the computer keyboard
- External numeric keypad

Instead, use the numeric keypad on the external keyboard.

To attach the external keyboard, turn off the computer, attach the keyboard to the keyboard connector of the keyboard/mouse cable

1 , and then attach the keyboard/mouse cable to the computer 2 .

You can attach a mouse to the mouse connector of the keyboard/mouse cable.

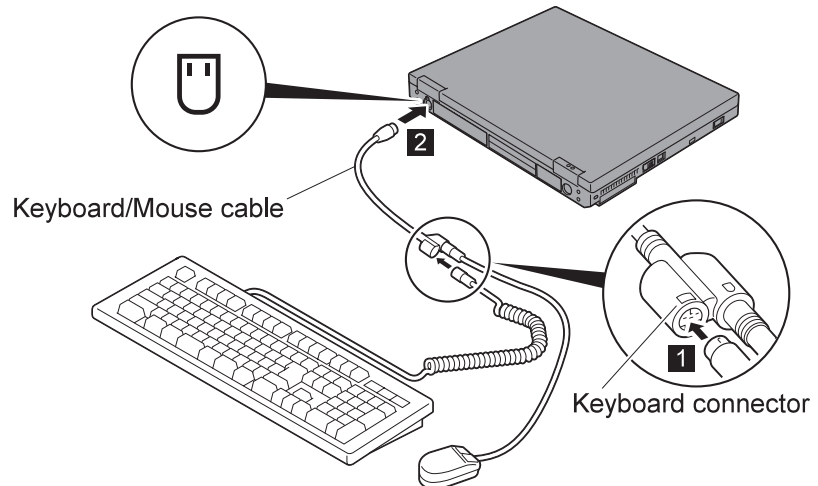

### Using the IBM ThinkPad Space Saver Keyboard

When using the IBM ThinkPad Space Saver Keyboard, **do not** install the device driver supplied with the Space Saver Keyboard. When the Space Saver Keyboard is used, the device driver on the computer's utility diskette automatically enables or disables the TrackPoint of the computer when power is turned on.



## Attaching External Mouse, Keypad, and Keyboard



### Disabling the TrackPoint

A mouse other than an IBM PS/2 Miniature mouse require the TrackPoint to be disabled before you can use them.

To disable the TrackPoint:



#### For Windows 95:

**1** Start the ThinkPad Configuration program.

See "ThinkPad Configuration Program" on page 24.

**2** Click on the **TrackPoint** () button.

**3** Click on **Disable** for the TrackPoint.

These changes become effective when computer power is turned off and then on again.



#### For Windows NT, Windows 3.1, and OS/2:

**1** Start the ThinkPad Configuration program.

**2** Click on the **Keyboard/Pointing Device** () button.

**3** Click on **Disable** for the TrackPoint.

These changes become effective when computer power is turned off and then on again.





## Attaching an External Monitor

This section provides information about using the computer LCD and an external monitor. It also provides considerations when using DOS applications.

The LCD of your computer uses thin-film transfer (*TFT*) technology or high performance addressing (*HPA*) technology. Both types of LCDs display output with XGA (1024x768 resolution) video mode and 64K colors.

If you are attaching an external monitor that supports a resolution higher than VGA mode, you can achieve a maximum of 1024x768 video resolution.

To attach an external monitor, do the following:

- 1** Turn off the computer.
- 2** Connect the external monitor to the external-monitor connector () at the rear of the computer; then connect the monitor to an electrical outlet.
- 3** Turn on the monitor and the computer.
- 4** Start the ThinkPad Configuration program.  
See "ThinkPad Configuration Program" on page 24.
- 5** Change the display output location by clicking on the **Both** () button or the **External Display** () button.



### Notes:

1. If you select the **Both** button, do not attach an external monitor that supports only VGA mode (640x480 resolution). Otherwise, the external monitor screen is scrambled and output is not displayed, or the screen might be damaged. Use **External Display** instead.
2. You can change the display output location by pressing **Fn+F7**.

## Attaching an External Monitor

### 6 Set your monitor type and display device driver as follows.

If you are attaching an SVGA monitor, refer to page 70 for information on the supported color depth or resolution.

**a)** Click on the **LCD** or **External Display** ( or ) button.

**b)** Click on the **Advanced Properties..** button.

You can select your monitor type from the monitor list, or click on a new resolution or refresh rate.

**Note:** Refer to the specifications for your external monitor to determine its supported resolutions and refresh rates.

### 7 Restart the computer to make the changes effective.

#### Attention

Do not change the display output location while a moving picture is being drawn—for example, while playing a movie or a game. Stop the application before changing the display output location.

## Display Output Location

You can change the display output location with the ThinkPad Configuration program. Select one of the following display output locations:

**LCD** (): The computer output is displayed only on the LCD of the computer.

**External Display** (): The computer output is displayed only on the attached external monitor.

If no external monitor is attached to the computer and the display output location is set to *External Display*, the output is displayed on the LCD.

**Both** (): The computer output is displayed on both the LCD and the external monitor.

## Attaching an External Monitor

You can also change the display output location as follows:

Using the **Fn** key function:

Press and hold the **Fn** key; then press the **F7** key. The output is displayed sequentially as follows:

External      Both  
Display

LCD

Using PS2 Command:

For DOS, use the PS2 command to change the display output location.

- Type `PS2 SC BOTH` to display information on both the LCD and external monitor.
- Type `PS2 SC CRT` to display information only on the external monitor.
- Type `PS2 SC LCD` to display information only on the LCD.

### Important

If you are using OS/2 Warp, do not use **System** in the System Setup folder to change the resolution or color depth. Use the ThinkPad Configuration program to configure the monitor.

**Do not disconnect the external monitor while the computer is in suspend mode or hibernation mode. If no external monitor is attached when the computer resumes, the LCD remains blank and output is not displayed. This restriction does not depend on the resolution value.**

## Attaching an External Monitor

### The DOS Screen Image on the LCD

If you use a DOS application that supports only VGA mode (640x480 resolution) with your computer, the screen image might appear smaller than the display size, as shown:

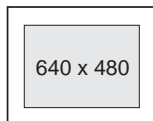

This is to maintain compatibility with DOS applications. To expand the screen image to the same size as the actual screen, you can use the *screen expansion* function. You can expand the screen image by clicking on the **LCD** button (  ) in the ThinkPad Configuration program or by entering the `PS2 HVEXP ON` command. However, the image might look slightly distorted.

## Display Modes

The following table shows the various display modes (resolution and color depth) available with your computer or external monitor. Use this table to set the display output (**LCD**, **External Display**, or **Both**).

**Note:**

When installing an operating system, you must install the display driver supplied with the computer to use SVGA mode.

Displaying output on the LCD, or both on the LCD and external monitor (**LCD** or **Both**).

Resolution	Supported Color Depth
640x480 (VGA)	16, 256, 65 536, and 16 777 216
800x600 (SVGA)	256, 65 536, and 16 777 216
1024x768 (XGA)	256 and 65 536



## Attaching an External Monitor

Displaying output only on the external monitor (**External Display**).

Resolution	Supported Color Depth	Frame Rate
640x480 (VGA)	256	60 Hz, 75 Hz, or 85 Hz
	65 536	
	16 777 216	
800x600 (SVGA)	256	60 Hz, 75 Hz, or 85 Hz
	65 536	
	16 777 216	
1024x768 (XGA)	256	60 Hz, 70 Hz, or 75 Hz
	65 536	

**Note:** If you are using an old external monitor, the resolution and color depth might be limited.



## Inserting a PC Card



# Inserting a PC Card

This section describes how to prepare to use a PC Card.

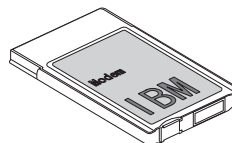

Your computer has two PC Card slots (upper slot and lower slot) and supports the following types of cards:

PC Card (Type I, Type II, and Type III)

CardBus

Zoomed Video (ZV)

**1** Find the notched edge **1** of the PC Card as shown.

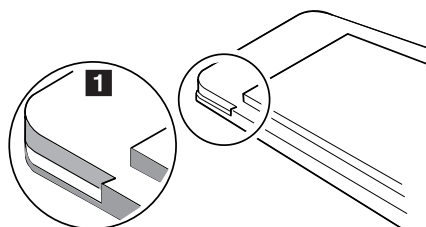

**2** Insert the PC Card into the appropriate slot according to your PC Card type.

If you are using a PC Card with an XJACK\*\* connector, insert it into the upper slot.

If you are using a Type I or Type II PC Card, insert it into either the upper slot or the lower slot.

If you are using a Type III PC Card, insert the card into the lower slot.

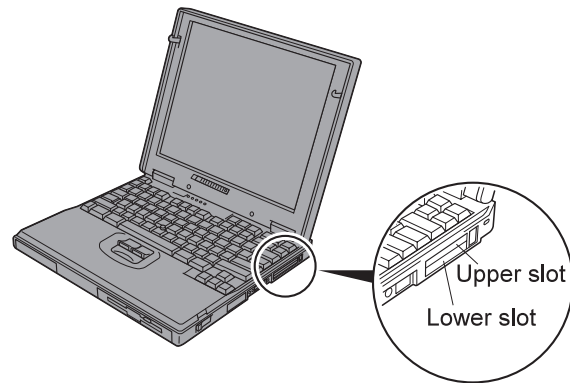

**Inserting a PC Card****3** Press the PC Card firmly into the connector.

Your ThinkPad has PC Card support software called CardWorks. You can use the PC Card as soon as you insert the card into the computer. The following window appears and informs you about the new card:

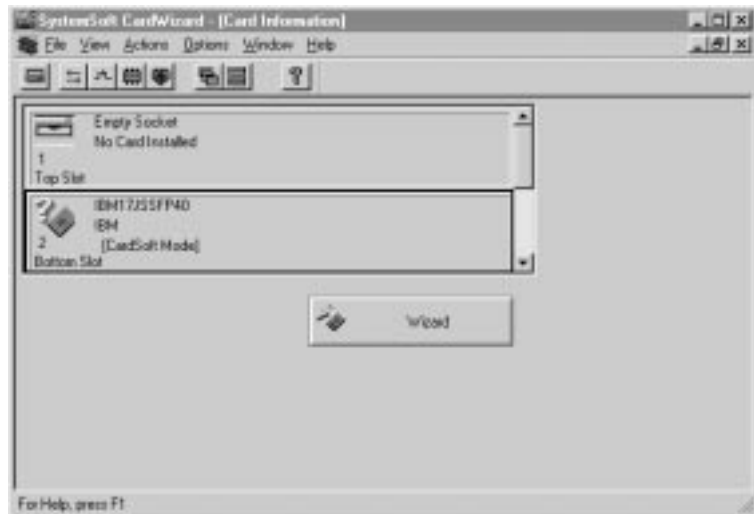

You have completed setting up the PC Card, and you can now use it. For information on how to use the PC Card Software

➔ [Online book](#)

If CardWorks does not have the device driver for the PC Card, the following “Select Installation Preference” window appears:

## Inserting a PC Card

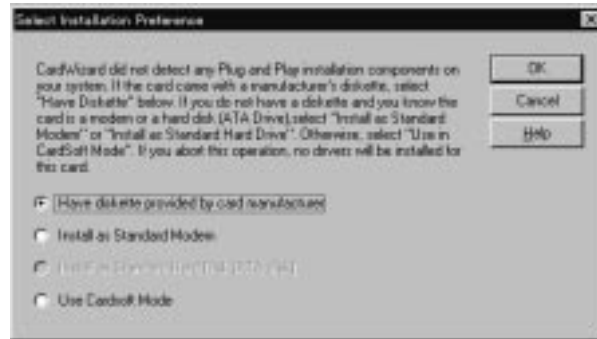

You have to install the PC Card driver. Follow the instructions on the next section.

### Installing the PC Card Driver

You are here because the CardWorks does not have the device driver of the PC Card. Install the device driver as follows:

- 1 Make sure that **Have diskette provided by card manufacturer** is selected in the “Select Installation Preference” window. Click on **OK**.

The following window appears:

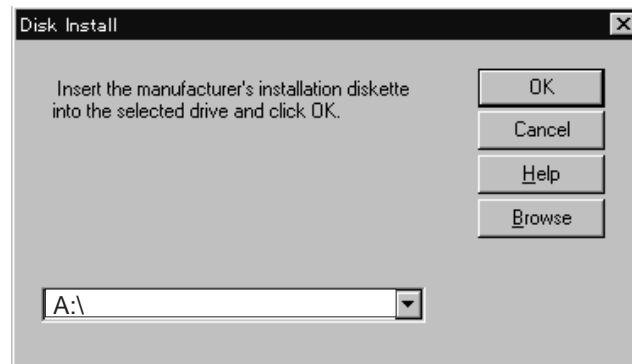

- 2 Insert the device driver (or option) diskette supplied by the PC Card manufacturer into the diskette drive.
- 3 Follow the instructions in the manual that came with the PC Card.

**Note:** If the CardWorks does not recognize your PC Card and you cannot install the PC Card driver, copy necessary INF files from the PC Card driver (or option) diskette to your `c:\WINDOWS\INF` directory prior to letting CardWorks detect the PC Card.

## Removing the PC Card

Before removing storage PC Cards, such as the hard disk PC Card, Flash memory PC Card, or SRAM PC Card, from the PC Card slot, **you must stop** the PC Card. Otherwise, data on the PC Card might be corrupted or lost.

### 1 Stop the card as follows:

**a** Click the right button on the CardWizard window.

The pop-up menu appears.

**b** Select **Stop** in the pop-up menu.

**Note:** The **Stop** option appears in gray when you are in CardSoft mode or when the card is already stopped.

**c** Click on **OK**; the following message appears:

The card has been stopped. You can safely remove the card.

**2** Press the PC Card eject button to pop out the button. Then press it again until the PC Card pops out.

**3** Remove the PC Card and store it safely for future use.

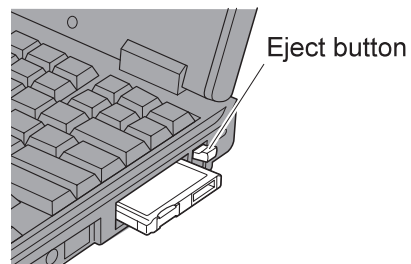

For more information for using a PC Card → [Online book](#)

## Using a Docking Station

# Using a Docking Station

You can extend the capabilities of your computer by attaching it first to the SelectaBase 600 port replicator and a docking station.

**Note:** The port replicator, available as an option, is a convenient way to attach several input devices and an external monitor. Of course you can also attach these devices directly to your computer.

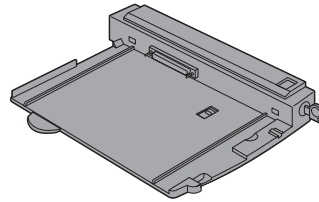

SelectaBase 600  
(Port Replicator)

Then you can attach (dock) the computer–port replicator–combination to one of the following docking stations:

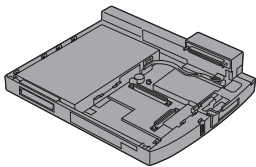

SelectaDock I

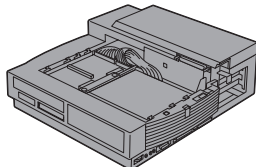

SelectaDock II

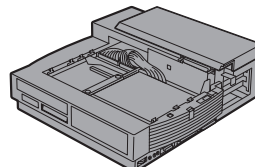

SelectaDock III

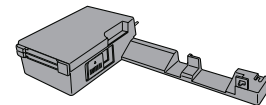

PC Card Enabler

You can dock your computer to a docking station under the following conditions:

- With your computer powered off (*cold docking*)
- With your computer in suspend mode (*warm docking*)
- With your computer operating (*hot docking*)

**Notes:**

1. Depending on the hardware configuration or the operating system, warm docking or hot docking might not be supported. Refer to the user's guide shipped with these docking stations or a port replicator for instructions on how to dock your computer to a docking station.
2. You might not be able to read the indicator panel or access the diskette drive easily on the SelectaDock I docking station after you dock it with the SelectaBase 600 port replicator.
3. In the Windows 95, Windows NT, Windows 3.1, or DOS environment, you need to install the PC Card support software *after* docking your computer to the docking station. If you have already installed the PC Card support software, uninstall it and then reinstall it after you dock your computer to the docking station.

***Docking with Your Computer Powered Off (Cold Docking)***

You should dock with both your computer and your docking station powered off if:

It is the first time you are docking your computer to the docking station.

***Or:***

You have changed the device configuration of your docking station, such as when you have installed or removed a device.

Cold docking resets the docking station's device status recorded on your computer. Thereafter, you can dock your computer with the docking station at any time.

To dock the computer for the first time, do the following:

**1** Install new devices in the docking station.

**2** Connect the power cord to the docking station.

If you use the SelectaDock I or SelectaDock II docking station, you need to connect the AC Adapter to the SelectaBase 600 port replicator.

**3** Dock your computer to the docking station.

See the user's guide shipped with the docking station for how to dock your computer to it. The  indicator appears on the



## Using a Docking Station



docking station LCD, indicating that the computer is properly docked.

### 4 Turn on the computer.

Windows 95 begins to check the status of the docking station and restarts a couple of times. Follow the instructions that appear on the screen.

During this operation, Windows 95 creates a configuration profile for the docking station with the name *Dock X*.

#### Notes:

1. *X* can be any number from 1 to 3. Your computer is capable of creating configuration information for three docking stations.
2. The message "Version Conflict" might appear on the screen. Answer **Yes** to the prompt "Do you want to keep this file?"

### 5 In Windows 95, select **My Computer, Control Panel, System**, and then the **Hardware Profile** tab.

### 6 Make sure the new profile, *Dock X*, is created. Also, select the **Device Manager** tab and make sure that the new devices are displayed in the device list.

If *Dock X* is not created, repeat from step 1.

If the symbol "!" or "x" appears next to the device symbol, a resource conflict might have occurred. Resolve the problem by referring to troubleshooting chapter in the online book.



After the new hardware profile *Dock X* is created, you can dock or undock your computer to the docking station while power is on.





## Undocking When Your Computer is Powered On or in Suspend Mode (Hot or Warm Undocking)

**Note:** If your computer does not enter suspend mode while it is docked in the docking station, do the following:

1. Start the ThinkPad Configuration program.
2. Click on the **Power Management** (  ) button.
3. Click on the **Suspend/Resume Options** (  ) button (Windows 3.1 only).
4. Click on the check box of **Suspend/hibernate while docked**.

Your computer can now enter suspend mode while docked.

To undock your computer from the docking station when the computer is operating (*hot undocking*) or when the computer is in suspend mode (*warm undocking*), do the following:

- 1** Select **Start** in Windows 95, and then **Eject PC**. The LCD on your computer turns off and on.

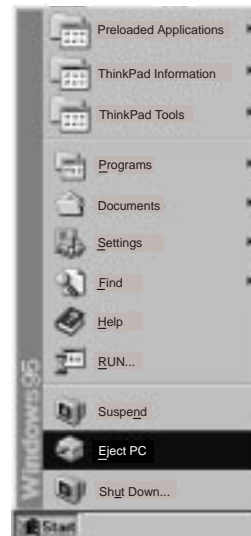

## Using a Docking Station

### Or:

Turn the security key of the docking station to the eject position and release the key.

An eject request is made to the operating system. It might take some time for this eject operation to end.

**Note:** To see if the eject operation is complete, click on **Start** again and see if the **Eject PC** icon still appears. If the icon still appears, wait until it disappears.

- 2 When you hear a beep, turn the security key to the rear again. Now you can eject your computer from the docking station.

**Note:** If the operating system rejects the eject request, a message appears on the screen. If this happens, try *cold undocking*.

### Presetting a Device to Avoid a Resource Conflict

The Windows 95 plug-and-play function enables you to use devices that you install in the docking station immediately after you power on your system. If you cannot use them, a system resource conflict might have occurred. Do the following to resolve the conflict:

For a PCI adapter or an SCSI device:

- 1 Start the ThinkPad Configuration program and click on the **Docking Station** () button.
- 2 Assign at least one IRQ value. The default setting is IRQ 11.

For an ISA adapter card:

- 1 Open Windows 95 Device Manager and check the resources available for the new card.
- 2 Set the jumper or the DIP switches on the adapter card.

For an IDE device such as a hard disk drive or a CD-ROM drive:

- 1** Start the ThinkPad Configuration program and click on the **Docking Station** () button.
- 2** Add a checkmark on **Enable IDE device in the Docking Station**, if there is none, and restart the computer.
- 3** Click on **Device Manager** and check whether there is a resource conflict between the new IDE device and the other devices in the computer. If there is a resource conflict, see the the online book.

### *Enabling the IDE Drive on the Docking Station*

If you have installed an IDE device (such as a hard disk drive or a CD-ROM drive) in the docking station, you must change the setting on your computer to enable the device. By default, your computer uses the primary IDE channel for the primary hard disk drive (Primary-Master) and the secondary IDE channel for a device in the UltraBay II (Secondary-Master). You cannot use the IDE device in the docking station in this default **2-channel default IDE mode**.

To enable an IDE device in the docking station, you must change the default setting to either of the following:

#### **3-channel IDE mode**

#### **2-channel IDE mode**

In 3-channel IDE mode, you can still use the hot and warm plug or unplug functions. An additional IRQ for the third IDE channel is required.

In 2-channel IDE mode, you do not have to assign an extra IRQ. However, you cannot use warm plug or unplug functions.

**Note:** If you change the IDE channel configuration, the drive letter assignment might be changed.



## ***Using a Docking Station***



### *Setting to 3-Channel IDE Mode*

- 1** Open the **ThinkPad Configuration** program.
- 2** Click on the **Docking Station** () button.
- 3** Change the IRQ value in **IRQ Holder for PCI Steering** to a value other than IRQ 11 or 15 (IRQ 9 is recommended).
- 4** Select **Enable IDE devices**.
- 5** Select **Third channel(IRQ 11, I/O 1E0)** in the IDE channel selection list box.
- 6** Click on **OK** to close the dialog box.
- 7** Select **OK** in the warning dialog box.  
The system restarts.

### *Setting to 2-Channel IDE Mode*

- 1** Open the **ThinkPad Configuration** program.
- 2** Click on the **Docking Station** () button.
- 3** Change the IRQ value in **IRQ Holder for PCI Steering** to a value other than IRQ 11.
- 4** Select **Enable IDE devices**.  
The third IDE is automatically selected.
- 5** Select **Secondary channel** in the IDE channel selection list box.
- 6** Click on **Disable Device** in the warning message dialog box.
- 7** Click on **OK** to close the dialog box.



**8** Select **OK** in the warning dialog box.

The system restarts. If necessary, change the IRQ value assigned to PCI to 11.

The following table shows the relationship between the devices and IRQ values:

Device	2-Channel IDE Default Mode	3-Channel IDE Mode	2-Channel IDE Mode
HDD	IRQ 14, P-M	IRQ 14, P-M	IRQ 14, P-M
UltraBay II	IRQ 15, S-M	IRQ 15, S-M	IRQ 14, P-S
Docking station	Disabled	IRQ 11, T-M and T-S	IRQ 15, S-M and S-S

**Legend:**

1. P-M: Primary-master
2. P-S: Primary-slave
3. S-M: Secondary-master
4. S-S: Secondary-slave
5. T-M: Third-master
6. T-S: Third-slave



## ***Using a Docking Station***





## Chapter 3. Protecting Your Computer

---



This chapter provides information about how to protect your computer from theft or unauthorized use. It also describes how to display your personal information, such as your name or address, on the password prompt screen.

Using Passwords . . . . .	86
Entering a Password . . . . .	87
Setting a Password . . . . .	88
Changing and Removing a Password . . . . .	92
For a Power-On Password or Hard Disk Password . . . . .	92
For a Supervisor Password . . . . .	94
Power-On Password with Supervisor Authority . . . . .	96
Using the Personalization Editor . . . . .	98
Entering Your Personal Data . . . . .	98
Deleting the Personalization Window . . . . .	101
Using Locks . . . . .	102



## Using Passwords

# Using Passwords

The password-setting feature helps to prevent your computer from being used by others. Once you set a password, a prompt appears on the screen each time you turn on the computer. You must enter your password at the prompt. You cannot use the computer unless you type the correct password. You can set the following passwords on your computer:

### Power-on password

Set the power-on password to protect your computer from use by another person. It provides the following security features:

- You need to type the power-on password at startup. Therefore, unauthorized users cannot use your computer.
- You need to type the power-on password when resuming from suspend mode. Therefore, unauthorized users cannot use your computer.

### Hard disk password

The hard disk password provides an extra measure of security. Even if you set a power-on password, another user can remove the hard disk drive in your computer and put it in a different computer to access your data. If you set a hard disk password, however, another person cannot access the data on your hard disk without knowing the password. It provides the following features:

- You need to type the hard disk password at startup.
- If the hard disk drive is moved to another computer, the hard disk password must be typed at startup. Therefore, unauthorized users cannot access your hard disk even if the drive is removed from the computer.
- The hard disk password is required when the computer resumes from suspend mode.

**Note:** The hard disk password might be disabled by your system administrator.



### **Supervisor password**

The supervisor password is a tool provided for the system administrator to control many ThinkPads computers. The supervisor password is set by the system administrator and it is not required for users. Users can start the computer without providing the supervisor password. The supervisor password is required only to access Easy-Setup. It provides the following security features:

- Only a system administrator can access Easy-Setup. If a supervisor password is set, a password prompt appears if you try to start Easy-Setup.
- You can use a power-on password to protect your data from unauthorized use, but the system administrator must set the power-on password.
- The system administrator can use the supervisor password to access the computer even if you have set a power-on password. The supervisor password overrides the power-on password.
- The supervisor password disables the hard disk password. The hard disk is protected by the supervisor password so that unauthorized users cannot access data on the hard disk. You will be unable to use your hard disk drive in a different computer that has its own supervisor password.
- The system administrator can set the same supervisor password on many ThinkPads to make administration easier.

### **Other password**

Some Microsoft operating systems provide special Windows passwords. Refer to that system's user's guide for information on how to set, change, and use these passwords.

## **Entering a Password**

Once you set a password, a password prompt appears at the top left corner of the screen. Each time you turn on your computer or when your computer returns from suspend mode to normal operation.

However, a password prompt is not displayed if the computer returns to normal operation by a preset timer or an incoming call on the modem, in which case you will have to display it by pressing a key or moving the pointing device.

## Using Passwords

To enter a password, do the following:

### 1 Type your password.

The **\*** symbol appears each time you press a key. Don't hold down a key too long, because the same character will be entered continuously.

### 2 Press the **Enter** key.

An **OK** appears if you enter the correct password, and an **X** appears if you enter the wrong password. If you fail to enter the correct password in three tries, you must turn off the computer, wait 5 seconds, and then turn it on again and retry.

## Setting a Password

To set a password, do the following:

### 1 Start Easy-Setup.

- a) Press and hold **F1**; then turn on the computer.
- b) Hold **F1** until the "Easy-Setup" menu appears.

### 2 Click on **Password** in the "Easy-Setup" menu. The "Password" submenu appears:

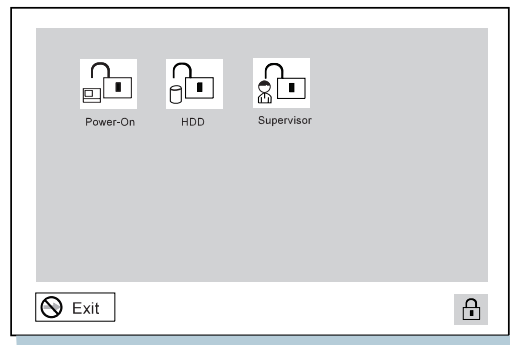

Selecting this icon displays a submenu for setting the **power-on** password.



Selecting this icon displays a submenu for setting the **hard disk drive (HDD)** password.



Selecting this icon displays a submenu for setting the **supervisor** password.

**Note:** An unlocked keylock icon indicates the password is not set.

**3** Click on the type of password you want to set:  
**Power-On, HDD, or Supervisor.**

**4** Type your desired appropriate password.

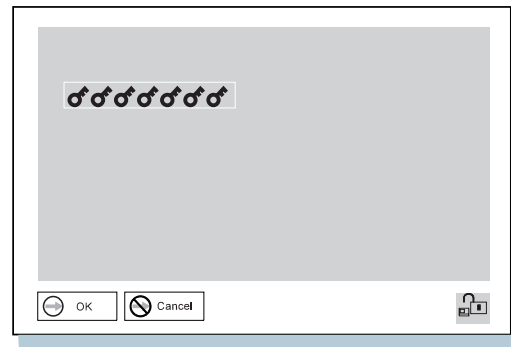

**Note:** You can type a maximum of seven random characters using a combination of letters (*A* to *Z*) and numbers (*0* to *9*). Uppercase and lowercase letters (for example, *A* and *a*) are treated as the same character.

If you type a wrong character, use the **Backspace** key to erase it and then type the correct one.



## Using Passwords



- 5** Press **Enter**. The “Password Confirmation” screen appears:

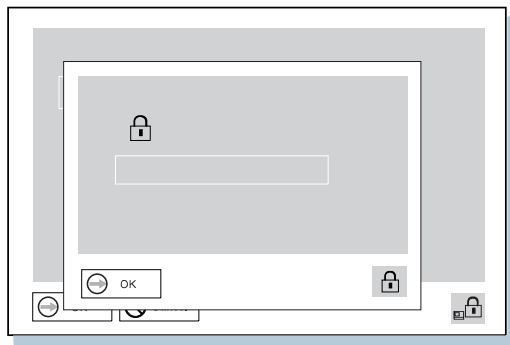

- 6** Type your password again to verify it; then press **Enter** again.

**Note:** The following screen appears if you are setting the hard disk or the supervisor password, reminding you to write down the password and keep it in a safe place.

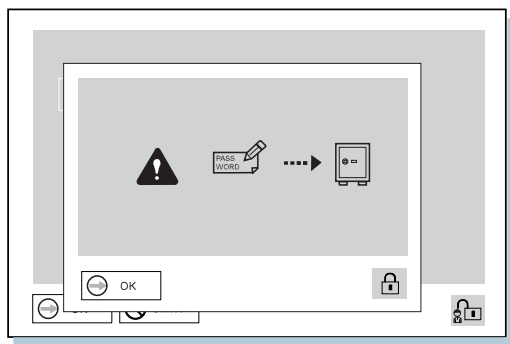

Your password is set.



**Do Not Forget Your Password**

If you forget your hard disk or supervisor password, there is **no way to reset your password or recover data from the hard disk**. You have to take your computer to an IBM reseller or an IBM marketing representative to have the hard disk or the system board replaced. Proof of purchase is required, and an additional charge might be required for the service. Neither an IBM reseller nor IBM marketing representative can make the hard disk drive usable.



## Changing and Removing a Password

This security feature prevents someone from removing a password and using your computer. To change or remove a password, do the following:

### *For a Power-On Password or Hard Disk Password*

- 1** Turn off the computer and wait at least 5 seconds; then turn on the computer.

The password prompt appears.

- 2** Type your current password.

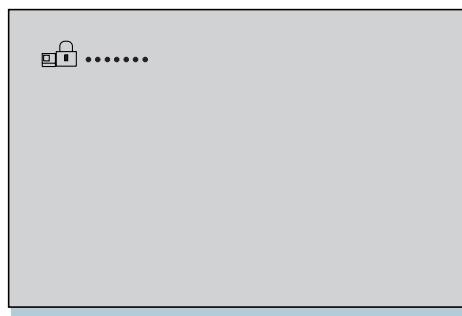

- 3** Press the **Spacebar**.

To change the password, go to step 4 on page 93 .

To remove the password, press **Enter**.

The following screen appears, and the system starts.



You have removed your password. Skip the remaining steps.





- 4** To change the password, type the new password; then press the **Spacebar**.

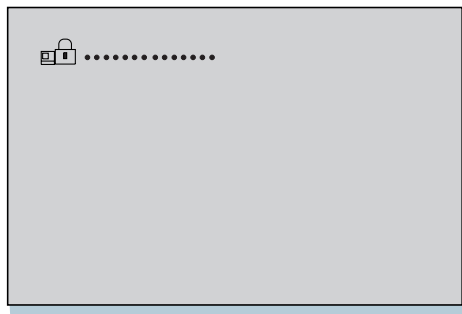

- 5** Type the new password again to verify it; then press **Enter**.

The following screen appears, and the system starts.

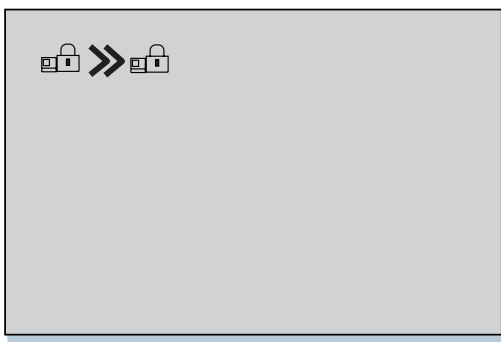

**Note:** Write down the password and keep it in a safe place. You have changed your password.





## Using Passwords



### For a Supervisor Password

#### 1 Start Easy-Setup.

- a) Press and hold **F1**; then turn on the computer.
- b) Hold **F1** until the password prompt appears.

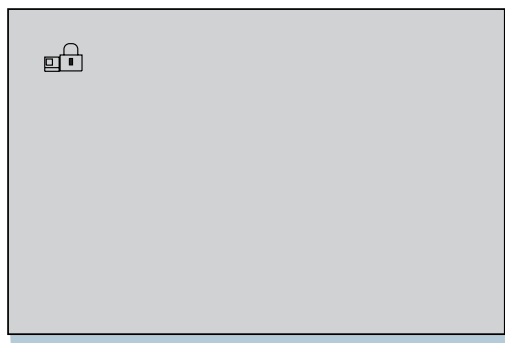

#### 2 Enter the supervisor password.

The “Easy-Setup” menu appears.

#### 3 Select **Password** on the menu.

#### 4 Select **Supervisor**.

To change the password, go to step 8 on page 95 .

#### 5 To remove the password, enter the current password and press the **Spacebar**.

#### 6 Press **Enter** twice.

#### 7 Click on **Exit**; then **Restart**.

The supervisor password has been removed. Your computer restarts. Skip the remaining steps.







**8** Enter the current password and press the **Spacebar**.



**9** Type the new password; then press **Enter**.

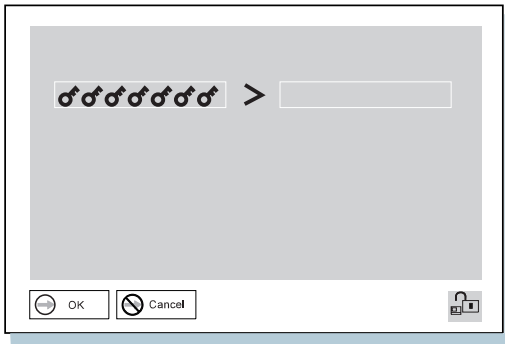



## Using Passwords



- 10 Type the new password again to verify it; then press **Enter**.

**Note:** The following screen appears, reminding you to write down the password and keep it in a safe place.

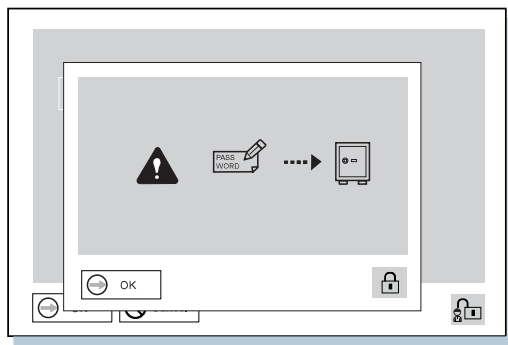

- 11 Press **Enter** again.

- 12 Click on **Exit**; then **Restart**.

The supervisor password has been changed. Your computer restarts.

## Power-On Password with Supervisor Authority

You can remove a power-on-password (even if you don't know it) if you know the supervisor password.

- 1 Power on the computer by pressing **F1**.

The password prompt appears.

- 2 Enter the supervisor password.

The "Easy-Setup" menu appears.

- 3 Select **Password** on the menu.

- 4 Select **Power on** on the menu.

- 5 Type the supervisor password; then press the **Spacebar**.



**6** Press **Enter**.

The “Password Confirmation” screen appears:

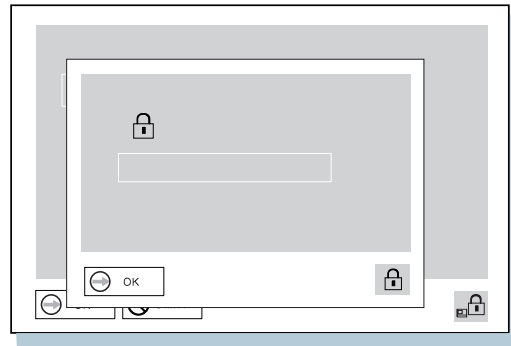

**7** Press **Enter** again.

**8** Click on **Exit**; then select **Restart**.

Your computer restarts. The power-on password has been removed.



## Using the Personalization Editor



# Using the Personalization Editor

With the Personalization Editor, you can display such personal information as your name and address on the screen each time you power on your computer. This feature helps you to identify your computer when identical computers are being used in your location, or to deter theft.

## Entering Your Personal Data

A personalized password-prompt window consists of two parts: the *personal data area* 1 and the *background bitmap area* 2 .

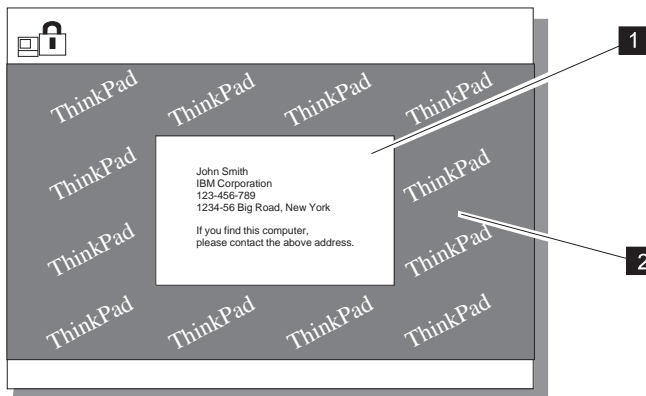

## Using the Personalization Editor

To register your name, address, and company on the Personalization Editor, do the following:

**Note:** To display this information, the power-on password must already be set.

- 1** Turn on the computer.
- 2** Make a backup copy of the *DOS, Personalization Utility Diskette* using your operating system's `diskcopy` command.
- 3** Insert the backup copy of the *DOS, Personalization Utility Diskette* into the diskette drive.
- 4** Open the **Personalization Editor**.
  - a)** Click on **Start**.
  - b)** Move the cursor to **Programs, ThinkPad**; then click on **Personalization Editor**.

The following window appears:



## Using the Personalization Editor

- 5** Click on **Personal Data** and type the necessary information into the boxes.

If you want to create the background bitmap, continue with step 6; otherwise, go to step 10.

- 6** Select **Background** in the “Personalization Editor” window.

Windows Paint automatically opens.

- 7** Draw an image or color the background.

Your bitmap size must be 160 by 100 pels. To change the size, select **Image** and then **Attribute**. Specify a **Width** of 160 and a **Height** of 100, and set **Unit** to pels.

- 8** Select **File** and **Save As** to save and name your drawing as a 16-color bitmap file on the backup copy of the *DOS, Personalization Utility Diskette*.

**Note:** To preview the actual full-size of the screen, select **Preview**.

- 9** Press **Enter** to return to the previous window.

- 10** Turn off the computer.

- 11** Insert the backup copy of the *DOS, Personalization Utility Diskette*. into the diskette drive; then turn on the computer.
- 12** Select **Update personalization data** at the menu window; then follow the instructions on the window.  
Your data is copied from the *DOS, Personalization Utility Diskette* and stored in the nonvolatile memory in the computer.
- 13** After the data is stored, turn off the computer.
- 14** Set your password if you have not yet set it.  
Click on **Help** for more information.

The information that you typed in will be displayed the next time you power on the computer.

## Deleting the Personalization Window

To delete the personalization window and revert to the default password prompt, do the following:

- 1** Turn off the computer.
- 2** Insert the backup copy of the *DOS, Personalization Utility Diskette* into the diskette drive; then turn on the computer.
- 3** Select **Delete personalization data** from the menu; then follow the instructions on the screen.
- 4** After the data is updated, restart the computer.



## Using Locks



# Using Locks

You can attach a mechanical lock to your computer, to help to prevent it from being removed without your permission.

Attach a mechanical lock to the keyhole 1 on the left side of the computer; then secure the chain on the lock to a secure stationary object.

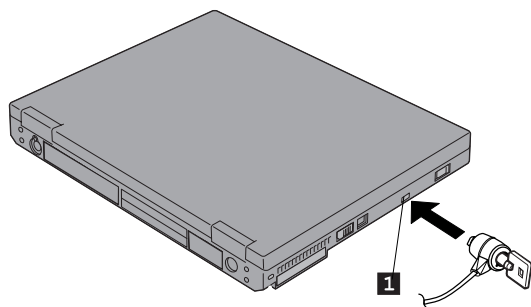

**Note:** You are responsible for evaluating, selecting, and implementing the locking devices and security features. IBM makes no comments, judgments, or warranties about the function, quality, or performance of locking devices and security features.





## Chapter 4. Solving Computer Problems

Frequently Asked Questions	104
Hints, Tips, and Limitations	111
Using the Power Management Modes	113
Using a PC Card with the Docking Station	113
USB Connector Considerations	113
For PCI Cards in the SelectaDock III Docking Station	113
For the USB Connector Setting on the SelectaDock III Docking Station	113
If a USB Device is Disabled	114
Using a Second CardBus Card	114
Using an External Condenser Microphone	114
Using the NetMeeting Software	115
Troubleshooting Guide	116
Troubleshooting Charts	117
Error Codes or Messages	118
No Error Codes or Messages	122
Input Problems	123
Suspend or Hibernation Problems	124
LCD Problems	128
An Indicator Problem	129
Battery Problems	129
CD-ROM Drive Problems	130
Infrared Communication Problems	131
An Audio or a Telephony Problem	132
A Universal Serial Bus (USB) Problem	132
A Modem Problem	133
PC Card Problems	134
Docking Station Problems	137
A Printer Problem	138
External Monitor Problems	139
Port Replicator Problems	140
Other Option Problems	141
Software Problems	142
Other Problems	142
Testing Your Computer	144
Test the SelectaDock I and II	146
Recovering Lost or Damaged Software	147
Using the Diskette Factory	148
Using the ThinkPad Customization CD	149
Using the Recovery CD	150

## *Frequently Asked Questions*

# Frequently Asked Questions

This section addresses frequently asked questions. Go to the page indicated in the following chart and do the specified action.

<b>Questions</b>	<b>Page</b>
How to stop the screen from blanking	105
How to set the infrared port	106
How to set the serial port	106
How to switch the TrackPoint and mouse	107
How to set the display resolution	108
How to set the external monitor	109
How to maximize the battery life	109
How to install the operation system	110
How to use the Recovery CD	110

## *Frequently Asked Questions*

To solve the problems discussed in this section, you need to use the ThinkPad Configuration program. To start the ThinkPad Configuration program, find the ThinkPad icon on the taskbar; then double-click on the icon.

The ThinkPad Configuration program window appears:

**Note:** You can also open the ThinkPad Configuration program as follows:

1. Click on **Start**.
2. Move the cursor on **Programs, ThinkPad**; then click on **ThinkPad Configuration**.

---

### **My screen keeps blanking when I do not want it to. How do I stop this?**

---

You can disable any system timers, such as the LCD turnoff timer or the power management mode timers with the ThinkPad Configuration program.

- 1 Start the ThinkPad Configuration program.
- 2 Click on the **Disable Screen Blanking** button.

## Frequently Asked Questions

---

### How do I use my infrared port as a communications port?

---

You can disable your computer's infrared port to free resources for another communication device, such as the serial port. If the infrared port is disabled, you must enable it before you can use it again. To enable your infrared port, do as follows:

- 1** Save your work and quit any program you are using.
- 2** Start the ThinkPad Configuration program.
- 3** Click on the **Infrared** button.
- 4** Click on **Enable**.

A "Warning" might appear that the hardware resource is being used by another communication device.

- 5** Click on **Disable Device**.

Another "Warning" window prompts you to restart your computer.

- 6** Click on **OK**. The computer restarts.

**Note:** If you check your infrared port and it is already enabled, you can use it immediately without changing any settings.

After your infrared port is enabled, you can use it as a communication port. If it does not work properly, you might have a problem with your communication software or the device that you are trying to communicate with. Check the online help system for your communication software if the other device appears to be working properly.

---

### How do I use my serial port as a communication port?

---

You can disable your computer's serial port to free resources for another communication device, such as the infrared port. If it is disabled, you must enable it before you can use it again. To enable your serial port, do as follows:

- 1** Save your work and any program you are using.
- 2** Start the ThinkPad Configuration program.

**3** Click on the **Serial Port** button.

**4** Click on **Enable**.

A “Warning” might appear that the hardware resource is being used by another communication device.

**5** Click on **Disable Device**.

Another “Warning” window prompts you to restart your computer.

**6** Click on **OK**. The computer restarts.

**Note:** If you check your serial port and it is already enabled, you can use it immediately without changing any settings.

After your serial port is enabled, you can use it as a communication port. If it does not work properly, you might have a problem with the communication software application or the cable or device attached to the serial port. Check the online help system for your communication software if the cable and attached device appear to be working properly.

---

### **How can I use an external mouse when I am at my desk, but then use the TrackPoint when I am away from my desk?**

---

The TrackPoint has an “auto/disable” setting that disables it when you power on or restart the computer with an external mouse attached. When you want to enable the TrackPoint, remove the external mouse; then restart the computer.

**Note:** You can set up the TrackPoint manually with the ThinkPad Configuration program as follows:

- 1** Start the ThinkPad Configuration program.
- 2** Click on the **TrackPoint** button.
- 3** Select **enable**, **disable**, or **auto/disable**.
- 4** Click on **OK**.

## Frequently Asked Questions

---

### Why do I not get the highest possible resolution out of my external monitor when I am using the LCD and external monitor at the same time?

---

You can set any resolution for either the ThinkPad LCD or the external monitor. When you use both at the same time, the resolution of both is the same. If you set a higher resolution for the ThinkPad LCD, you can see only part of the screen at a time. You can see other parts by moving the image with the TrackPoint or other pointing device. You can change the display output type to the LCD, external monitor, or both with the **Display Device** buttons of the ThinkPad Configuration program or with **Fn+F7**.

You can set up the external monitor as follows:

- 1** Double-click on **My Computer, Control Panel**; then **Display**.
- 2** Click on the **Properties...** button. The "Display Properties" window appears.
- 3** Click on the **Settings** tab.
- 4** Click on **Advanced Properties**.
- 5** Click on **Monitor**.
- 6** Click on the **Change** button.
- 7** Select **Show All Devices**.
- 8** Select **Manufacturers and Models** in the next window.
- 9** Click on **OK**; then **Close**.
- 10** Set **Color palette** and **Desktop area** in the "Display Properties" windows.
- 11** Click on **OK**.

---

**How can I set up the external monitor if the Windows plug-and-play feature does not detect it?**

---

Do as follows:

- 1** Double-click on **My Computer, Control Panel**; then **Display**.
- 2** Click on the **Properties...** button. The “Display Properties” window appears.
- 3** Click on the **Settings** tab.
- 4** Click on **Advanced Properties**.
- 5** Click on **Monitor**.
- 6** Make sure that **Automatically Detect Plug and Play Monitors** is checked.
- 7** If the option is checked and your monitor is still not recognized after you restart the computer, click on the **Change** button.
- 8** Select the monitor type that you have attached and then click on **OK**.
- 9** Click on **Close**.
- 10** If you are prompted to restart your computer, click on **OK**.

---

**How do I maximize battery life?**

---

To maximize battery life, do the following:

Use the battery until the charge is completely depleted (until the battery and power LEDs flash in unison).

Recharge the battery completely before using (the battery is fully charged when the AC Adapter is plugged in and the battery LED is green).

For a new battery or a battery that you have not used recently:

## **Frequently Asked Questions**

1. Use the battery until the charge is completely depleted (until the battery and power LEDs flash in unison).
2. Recharge completely before using (the battery is fully charged when the AC Adapter is plugged in and the battery LED is green).
3. Repeat these steps three times.

Always use power management features such as Advanced Power Management (APM), power modes, standby, suspend, and hibernation.

For more detailed information about power management features → [Online book](#)

---

### **How do I load a different operating system on my computer?**

–Or–

### **Where do I get ThinkPad device drivers for this operating system?**

---

See the online book for information on installing a new operating system and device drivers. You can get the ThinkPad device drivers by using the Diskette Factory. Before installing a new operating system, do the following:

Print the software installation section of the online book.

Make backup diskettes of the device drivers and applications for your new operating system with the Diskette Factory. See “Using the Diskette Factory” on page 148.

Make a DOS system diskette that has the DOS FDISK.COM and FORMAT.COM utilities and the CD-ROM device driver for DOS.

---

### **How do I use the Recovery CD to reload my factory-installed ThinkPad operating system and applications?**

---

See “Using the Recovery CD” on page 150.



## Hints, Tips, and Limitations

This section provides hints, tips, and limitations.



### For Windows 95:

If you are using the Intel USB camera and the system resumes from suspend mode, the USB camera is disabled. To enable it, unplug it and plug it in again.

Your computer might not enter suspend mode or hibernation mode after the end of a timeout period that was specified in the ThinkPad Configuration program because of the CD-ROM drive property settings. If you want to use suspend mode and hibernation mode, change the properties of the CD-ROM drive as follows:

1. Click on **Start** and move the cursor to **Settings** and **Control Panel**. Then click on **Control Panel**.
2. Double-click on **System**.
3. Click on the **Device Manager** tab and double-click on **CD-ROM**.
4. Click on the CD-ROM drive name under the **CD-ROM**; then click on the **Properties** button.
5. Click on the **Settings** tab and remove the check mark from the **Auto insert notification** check box in **Option** by clicking on it.
6. Click on **OK**, and restart the computer.

## Hints, Tips, and Limitations



### For OS/2 Warp:

If you have formatted your drive using high-performance file system (HPFS) and your system has more than 64 MB memory installed, hibernation is not supported.

If the COM port does not work even if you have set it up correctly with the ThinkPad Configuration program, do as follows:

1. Open **System Setup**.
2. Select **Hardware Manager**.
3. Select a folder from the menu.
4. Select **Properties**.
5. In the default pull-down menu, select **No Hardware Detection**. If it has already been selected, change the setting.
6. Open the ThinkPad Configuration program.
7. Set the COM port as desired.
8. Restart the system.

If you receive incoming faxes or mail under OS/2, you must set the modem settings in the fax application to one of the following:

- Hardware FIFO enabled
- Hardware Flow Control on
- UART 16550A modem

In OS/2 FaxWorks for example, select **Utilities, Settings, Modem Type**, and **Use HW FIFO (16550A)**.

If you do not set your modem to one of these settings, you will not be able to receive an incoming fax or an incoming call in suspend mode.



### For Windows NT:

For Windows NT 4.0, hibernation is not supported if the drive is formatted by NTFS.

For more information, refer to the following Web site:  
<http://www.pc.ibm.com/thinkpad>

## Using the Power Management Modes

You can select either the **Resume on incoming call** option or the **Hibernate X minutes after suspend** option but not both. If you select one option, the other option becomes gray and cannot be selected.

To enable **Resume on incoming call**, do as follows:

1. Start the ThinkPad Configuration program.
2. Click on the **Resume/Suspend options** tab.
3. Click on **Resume on incoming call**.

To enable **Hibernate X minutes after suspend**, do as follows:

1. Start the ThinkPad Configuration program.
2. Click on the **Hibernation** tab.
3. Click on **Hibernate X minutes after suspend**.

## Using a PC Card with the Docking Station

In the Windows 95, Windows NT, Windows 3.1, or DOS environment, you need to install the PC Card support software *after* docking your computer to the docking station. If you have already installed the PC Card support software, uninstall it and then reinstall it after you dock your computer to the docking station.

## USB Connector Considerations

### *For PCI Cards in the SelectaDock III Docking Station*

When the setting of the USB connector on your computer is enabled (the default setting), do not use a PCI Video Card and a PCI Network Card at the same time in the SelectaDock III docking station. Your system cannot start if both cards are inserted.

### *For the USB Connector Setting on the SelectaDock III Docking Station*

Do not disable the USB connector on the SelectaDock III. If you disable it, the system might hang during a hot- or warm-dock or undock operation. If this occurs, cold-boot the system for recovery.

## ***Hints, Tips, and Limitations***

### ***If a USB Device is Disabled***

If your computer tries to enter suspend mode and the request is rejected, the device in the USB connector might be disabled. If this occurs, do a hot-unplug and -plug operation for the USB device.

### **Using a Second CardBus Card**

If a CardBus Card is already configured in your computer or in the docking station (SelectaDock III or PC Card Enabler), you must configure the second CardBus manually by using the Device Manager. To get to the Device Manager, click on the **System** icon in the Control Panel.

### **Using an External Condenser Microphone**

If you are using a microphone with your computer, use the ThinkPad-option headset. Some microphones, such as condenser microphones, might need a battery. See the instruction which comes with the microphone.

The microphone/line-in jack supports the following type of microphones:

- A dynamic microphone
- A self-battery-powered condenser microphone

The microphone/line-in jack of your computer supports either of microphone input or line-in input but not both. You need to mute the function you don't use, as follows:

1. Click on **Start**.
2. Move the cursor to **Programs, Accessories, Multimedia**, and then **Volume Control**.
3. Put a check mark in the **Mute** check box in the column you don't use—either **LINE** or **MIC**.

## Using the NetMeeting Software

When you are hanging up a video phone call in NetMeeting, you might see a Windows exception error message; "An exception OE has occurred in VxD VWIN32( 1)...". This message appears only when you are making a video phone call directly over the telephone line and after you use such data sharing tools as the whiteboard, file transfer, chat, and application sharing. If this error occurs, shut down Windows and restart your computer. This error does not occur if you are using the Intel Video Phone for Internet Video Conferencing software.



## Troubleshooting Guide

The following chart shows how to find or solve a problem.

### **If a beep sounds, a message appears, or a function-related problem occurs:**

1. Find your symptom in the Troubleshooting Charts and try solving the problem. → "Troubleshooting Charts" on page 117
2. If you can't solve the problem, run a test and make sure the hardware and the device drivers are OK. → "Testing Your Computer" on page 144
3. Note the error code and have the computer serviced. → Chapter 5, "Getting Service" on page 153

### **If you accidentally lose or damage software in your computer:**

Recover it by using either the ThinkPad Customization CD, the Recovery CD, or the Diskette Factory.

- "Recovering Lost or Damaged Software" on page 147



## Troubleshooting Charts

If your computer has an error, it often displays a message or an error code, or a beep sounds when you power it on. Go through the charts and look for your problem. If you find the problem, go to the page indicated and do the specified action.

<b>Troubleshooting Chart</b>	<b>Page</b>
Error codes or screen messages	118
No error codes or screen messages	122
Input problems	123
Suspend or hibernation problems	124
LCD problems	128
An indicator problem	129
Battery problems	129
CD-ROM drive problems	130
Infrared communication problems	131
Audio or telephony problems	132
An universal serial bus (USB) problems	132
Modem problems	133
PC Card problems	134
Docking station problems	137
A printer problem	138
External display problems	139
Port replicator problems	140
Other option problems	141
Software problems	142
Other problems	142



## Troubleshooting Charts

### Error Codes or Messages



**Note:** In the charts, x can be any character.





Message	Action
I9990301 I9990302 I9990305  (Incorrect connection of the hard disk drive might cause these error codes to appear.)	Your computer can't find the startup drive. Do the following: <ol style="list-style-type: none"> <li>1. Turn off the computer.</li> <li>2. Press and hold <b>F1</b>; then turn on the computer to start Easy-Setup. Hold <b>F1</b> until the Easy-Setup menu appears.</li> <li>3. Select the <b>Start up</b> icon.</li> <li>4. Select <b>Power-On</b> or <b>Network</b>. If you are unable to set the startup sequence, have the computer serviced.</li> <li>5. Check the devices in the startup sequence box. Is the default drive listed in the startup sequence box?  <b>Yes</b> Exit this window, and turn off the computer.  <b>No</b> Select the <b>Reset</b> icon.</li> <li>6. Is an operating system installed?  <b>Yes</b> Go to step 8.  <b>No</b> Install the operating system in your computer.</li> <li>7. After you install the operating system, turn off the computer.</li> <li>8. Turn on the computer.</li> </ol> If the same message appears, have the computer serviced.
I99xxxxx (except the above I999030x errors)	Have the computer serviced.
111 (docking station error)	If you are using a port replicator or a docking station, disconnect it; then reconnect it.  If you still have a problem, refer to the manual shipped with your port replicator or docking station.
16x or 17x (undefined date or configuration error)	Follow the instructions on the screen.
174 (device configuration error)	Make sure that the hard disk drive is connected correctly. If the problem persists, have the computer serviced.

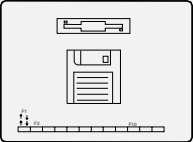

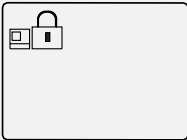
Message	Action
184 (invalid password error)	The password entered is invalid.  Turn off the computer and wait at least 5 seconds; then turn it on again and type the correct password.
190 (critical low-battery error)	The computer turned off because the battery is low.  Connect the AC Adapter to the computer and charge the battery pack, or replace the battery pack with a fully charged one.
192 (cooling fan error)	Have the computer serviced.
195 (hibernation error)	The system configuration differs between the time your computer entered hibernation mode and the time it exited this mode, and your computer cannot resume normal operation.  Change the system configuration to what it was before your computer entered hibernation mode. If the memory size was changed, re-create the hibernation file.  <b>For Windows 95:</b> <ol style="list-style-type: none"> <li>1. Start the ThinkPad Configuration program.</li> <li>2. Click on <b>Power Management</b> ().</li> <li>3. Click on the <b>Hibernation</b> tab.</li> <li>4. Make sure that hibernation mode is enabled.</li> </ol> <b>For Windows NT:</b> <ol style="list-style-type: none"> <li>1. Start the ThinkPad Configuration program.</li> <li>2. Click on <b>Power Management</b> ().</li> <li>3. Click on <b>Suspend/Resume Options</b> ().</li> <li>4. Make sure that hibernation mode is enabled.</li> <li>5. Click on <b>OK</b>.</li> </ol>
196 (hibernation error)	The computer cannot read the hibernation file.  Have the computer serviced.
225 (unsupported memory)	The installed DIMM is not supported.  <b>Note:</b> The ThinkPad 600 computer supports SDRAM only. It does not support EDO DRAM.
2xx (memory error)	Make sure that the DIMM option is correctly installed.

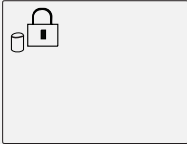
## Troubleshooting Charts

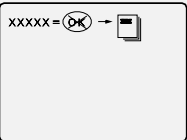
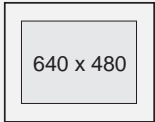
Message	Action
<p>30x (keyboard error)</p>	<p>Make sure that no object is placed on the keyboard or on the external keyboard, if you have one. Power off the computer and power off all attached devices. Power on the computer first; then power on the attached devices.</p> <p>If you still have a problem, do the following:</p> <p>If an external keyboard is connected, do the following:</p> <ul style="list-style-type: none"> <li>– Turn off the computer and disconnect the external keyboard; then turn on the computer. Make sure that your keyboard operation is correct. If it is, have the external keyboard serviced.</li> <li>– Make sure that the external keyboard is connected to the correct connector.</li> </ul> <p>Test the computer by selecting the <b>Start</b> icon in the Easy-Setup “Test” submenu.</p> <ul style="list-style-type: none"> <li>– If the computer stops during the test, have the computer serviced.</li> </ul>
<p><b>Diskette</b> and <b>F1</b> prompts</p> 	<p>Make sure that the self-starting diskette is inserted correctly (with the label facing up and metal-shutter end first) in the diskette drive.</p> <p>If it is, press <b>F1</b>. If both prompts remain, have the computer serviced.</p>
<p>A 163 error appears and then the <i>Date and Time</i> window appears.</p> 	<p>Neither the date nor the time is set in the computer.</p> <p>Set the date and time by typing or clicking on ▲ or ▼ to set the values; then click on <b>OK</b>.</p> <p>When both the power-on password and supervisor password are set, do the following:</p> <ol style="list-style-type: none"> <li>1. Power on the computer. The password prompt appears after the error code.</li> <li>2. Type the supervisor password, not the power-on password. An error window appears.</li> <li>3. Click on <b>OK</b> or press <b>Enter</b>.</li> <li>4. Set the time and date on the next window; then press <b>Enter</b>. The system restarts.</li> </ol>
<p>The power-on password prompt</p> 	<p>A power-on password or supervisor password is set. Type the correct password and press <b>Enter</b> to use the computer (see page 88).</p> <p>If the power-on password is not accepted, a supervisor password might have been set. Type the supervisor password and press <b>Enter</b>.</p> <p>If you still have a problem, have the computer serviced.</p>

Message	Action
<p>The hard disk password prompt</p> 	<p>A hard disk drive password is set. Type the correct password and press <b>Enter</b> to use the computer (see page 88).</p> <p>If you still have a problem, have the computer serviced.</p>
<p>The “Test” submenu</p> 	<p>Select the <b>Start</b> icon and follow the instructions to test your system.</p> <p>If you cannot complete the test, have the computer serviced.</p> <p>If the test does not find the problem but the problem persists, see if you can find your problem in the Troubleshooting Charts.</p> <p>If the test ends in an error, note the error code and have the computer serviced.</p>
<p>A POST error prompt</p> 	<p>An error was found during POST. Press <b>Enter</b>; then select <b>Start</b> from the “Test” submenu and run the test.</p> <p>If the test ends in an error, note the error code and have the computer serviced.</p>
<p>An error prompt</p> 	<p>Turn off the computer and start Easy-Setup; then select <b>Test</b> to test the computer.</p> <p>If the test ends in an error, note the error code and have the computer serviced.</p> <p>You can start the operating system by pressing <b>F1</b> instead, and ignore the error.</p>
<p>The DOS full-screen looks smaller.</p> 	<p>When you use a DOS application that supports only the 640x480 resolution (VGA mode), the screen image might look slightly distorted or might appear smaller than the display size. This is to maintain compatibility with other DOS applications. To expand the screen image to the same size as the actual screen, start the ThinkPad Configuration program and click on <b>LCD</b> (); then select the <b>Screen expansion</b> function. (The image might still look slightly distorted.)</p> <p><b>Note:</b> You can use the <b>Fn+F8</b> keys to do the same thing.</p>
<p>A panel or message that is not listed in the troubleshooting charts.</p>	<p>Turn off the computer and start Easy-Setup; then select <b>Test</b> to test the computer.</p> <p>If the test ends in an error, note the error code and have the computer serviced.</p> <p>If you cannot start Easy-Setup, have the computer serviced.</p>

## Troubleshooting Charts

Message	Action
xxxxx KB OK appears and the computer stops.	Have the computer serviced.

## No Error Codes or Messages

Problem	Action
<p>The screen is blank and you don't hear any beeps.</p> <p><b>Note:</b> If you are not sure whether you heard any beeps, turn the computer off; then turn it on again, and listen again.</p> <p>If you are using an external monitor, go to "External Monitor Problems" on page 139.</p>	<p>Make sure that:</p> <ul style="list-style-type: none"> <li>The battery pack is installed correctly.</li> <li>The AC Adapter is connected to the computer and the power cord is plugged into a working electrical outlet.</li> <li>The computer power is on. (Turn on the power switch again for confirmation.)</li> </ul> <p>If a power-on password is set, press any key to display the power-on password prompt, and then type the correct password and press <b>Enter</b> (see page 88).</p> <p>If the power-on password does not appear, the brightness control might be set to minimum brightness. Adjust the brightness.</p> <p>If the screen still remains blank, have the computer serviced.</p>
<p>The screen is blank and you hear a continuous beep, or two or more beeps.</p>	<p>Have the computer serviced.</p>
<p>Only the cursor appears.</p>	<p>Reinstall your operating system and turn on the computer.</p> <p>If you still have a problem, have the computer serviced.</p>

## Input Problems



Problem	Action
The cursor does not move after the computer awakens from one of the power management modes.	Make sure you followed the instructions in the online book correctly when you installed Windows with the Advanced Power Management (APM) option.
All or some keys on the keyboard do not work.	<p>If the problem occurred immediately after the computer returned from suspend mode, enter the power-on password if it is set.</p> <p>If an external keyboard is connected, the numeric keypad on your computer will not work. This is not a defect.</p> <p>If an external numeric keypad or a mouse is connected:</p> <ol style="list-style-type: none"> <li>1. Turn off the computer.</li> <li>2. Remove the external numeric keypad or the mouse.</li> <li>3. Turn on the computer and try using the keyboard again.</li> </ol> <p>If the keyboard problem is solved, check the connection of the external numeric keypad, external keyboard, or mouse.</p> <p>If you still have a problem, have the computer serviced.</p>
The cursor drifts when the computer is turned on or after it resumes normal operation.	<p>The cursor might drift when you are not using the TrackPoint during normal operation. This is a normal characteristic of the TrackPoint and is not a defect. Cursor drifting might occur for several seconds under the following conditions:</p> <ul style="list-style-type: none"> <li>When the computer is turned on.</li> <li>When the computer resumes normal operation.</li> <li>When the TrackPoint is pressed for a long time.</li> <li>When the temperature changes.</li> </ul>
The mouse or pointing device does not work.	<p>Make sure that the pointing device is enabled in the ThinkPad Configuration program.</p> <p>Make sure that the mouse or pointing-device cable is securely connected to the computer.</p> <p>Try using the TrackPoint. If the TrackPoint works, the error might be due to the mouse.</p> <p>If your mouse is incompatible with the IBM PS/2 mouse, disable the TrackPoint using the ThinkPad Configuration program.</p> <p><b>Note:</b> See the manual supplied with the mouse for more information.</p>
The mouse buttons don't work.	Reinstall the Standard PS/2 Port Mouse driver; then reinstall the PS/2 TrackPoint driver. See the online book for how to install the driver.

## Troubleshooting Charts

Problem	Action
The scrolling or Magnifying Glass function doesn't work.	See the General tab page in "Mouse Properties," and make sure that the PS/2 TrackPoint driver is loaded. <b>Note:</b> Refer to the README in the TrackPoint driver diskette for driver installation.
A number appears when you type a letter.	The numeric lock function is on. To disable it, press and hold <b>Shift</b> ; then press <b>NumLk</b> .
All or some keys on the external numeric keypad do not work.	Make sure that the external numeric keypad is correctly connected to the computer.
All or some keys on the external keyboard do not work.	To use an external keyboard, you need to attach the keyboard/mouse cable to the computer. Make sure that:  The keyboard/mouse cable is correctly connected to the computer.  The keyboard cable is connected to the correct side of the keyboard/mouse cable.  If these items are correct, disconnect the keyboard/mouse cable from the computer and make sure that the operation of the system keyboard is correct. If the system keyboard works, have the keyboard/mouse cable or the external keyboard serviced.

## Suspend or Hibernation Problems



Problem	Action
The computer enters suspend mode automatically.	The computer enters suspend mode automatically when the processor temperature reaches a certain level. This is not a defect.
Performance degrades when the computer gets hot during use.	The processor speed might decrease under the following conditions:  Use in a hot environment High-powered processing that requires high-power consumption  This is not a defect.
The computer enters suspend mode immediately after POST (the suspend indicator turns on).	Make sure that:  The battery pack is charged. The operating temperature is within the acceptable range. Refer to Appendix A, "Features and Specifications" on page 165.  If these items are correct, have the computer serviced.

Problem	Action
Error 19 appears and the computer immediately turns off.	The battery pack power is getting low. Connect the AC Adapter to the computer, or replace the battery pack with a fully charged one.
The computer does not return from suspend mode, or the suspend lamp stays on and the computer does not work.	The computer automatically enters suspend or hibernation mode when the battery power is exhausted. Do one of the following:  Replace the battery pack with a fully charged one and then press <b>Fn</b> . Connect the AC Adapter to the computer; then press <b>Fn</b> .
The LCD is blank after resuming.	Check if an external monitor was connected before the computer entered suspend mode. <b>Do not disconnect the external monitor while the computer is in suspend mode or hibernation mode. If no external monitor is attached when the computer resumes, the LCD remains blank and output is not displayed. This restriction does not depend on the resolution value.</b>
Your computer does not enter suspend or hibernation mode.	Check if the suspend or hibernation mode is disabled. If you are using the AC Adapter and your computer is connected to a network, do the following:  <b>For Windows 95:</b>  1. Start the ThinkPad Configuration program. 2. Click on <b>Power Management</b> (  ). 3. Click on <b>Hibernation</b> tab. 4. Make sure that hibernation mode is enabled.  <b>For Windows NT:</b>  1. Start the ThinkPad Configuration program. 2. Click on <b>Power Management</b> (  ). 3. Click on the <b>Suspend/Resume Options</b> (  ). 4. Make sure that hibernation mode is enabled. 5. Click on <b>OK</b> .

## Troubleshooting Charts

Problem	Action
<p>The computer does not enter suspend mode as set by the timer under Windows 95 or Windows NT.</p>	<p><b>For Windows 95:</b></p> <p>The Windows 95 generic CD-ROM driver accesses the internal CD-ROM drive every 3 seconds to see if a CD-ROM is inserted in the CD-ROM drive. This prevents your computer from entering suspended mode even after a timeout.</p> <p>To prevent this from occurring, do the following:</p> <ol style="list-style-type: none"><li>1. Double-click on <b>My Computer, Control Panel, and System.</b></li><li>2. Click on the <b>Device Manager</b> tab.</li><li>3. Click on the + mark of <b>CD-ROM.</b></li><li>4. Double-click on the CD-ROM drive name.</li><li>5. Click on the <b>Setting</b> tab.</li><li>6. Remove the check mark from <b>Auto insertion notification.</b></li></ol> <p>Windows 95 no longer detects the CD-ROM insertion automatically.</p> <p><b>For Windows NT:</b></p> <p>The computer does not enter suspend mode by the timer if you enable the CD-ROM AutoRun feature. To enable the Suspend Timer function in the registry, do the following:</p> <pre>HKEY_LOCAL_MACHINE\SYSTEM\CurrentControlSet\Services\Cdrom\ Autorun:  x1 → Autorun:</pre>



Problem	Action
<p>The computer does not enter hibernation mode with the <b>Fn+F12</b> key combination.</p>	<p>Enable hibernation mode as follows:</p> <p><b>For Windows 95:</b></p> <ol style="list-style-type: none"> <li>1. Start the ThinkPad Configuration program.</li> <li>2. Click on <b>Power Management</b> ().</li> <li>3. Click on the <b>Hibernation</b> tab.</li> <li>4. Click on <b>Enable Hibernation</b>.</li> </ol> <p><b>Note:</b> If you have already created the hibernation file, this button is displayed in gray and you cannot click on it.</p> <ol style="list-style-type: none"> <li>5. Click on <b>Create Now</b>.</li> <li>6. Click on <b>OK</b>.</li> </ol> <p>The computer cannot enter hibernation mode when you are using one of the IBM communication PC Cards.</p> <p>To enter hibernation mode, stop the communication program, and then remove the PC Card or turn off power to the PC Card slot using the <b>Control Panel</b>.</p> <p><b>For Windows NT:</b></p> <p><b>Note:</b> You must format your hard disk with the FAT format system to use hibernation mode in Windows NT. When you format your hard disk with NTFS, the Windows NT default format, you will not be able to use hibernation mode.</p> <ol style="list-style-type: none"> <li>1. Start the ThinkPad Configuration program.</li> <li>2. Click on <b>Power Management</b> ().</li> <li>3. Click on <b>Suspend/Resume Options</b> ().</li> <li>4. Click on <b>Enable Hibernation</b>.</li> <li>5. Click on <b>OK</b>.</li> </ol> <p>The computer cannot enter hibernation mode when you are using one of the IBM communication PC Cards.</p> <p>To enter hibernation mode, stop the communication program, and then remove the PC Card or turn off power to the PC Card slot using the <b>Control Panel</b>.</p>

## Troubleshooting Charts

### LCD Problems

Problem	Action
The screen is unreadable or distorted.	<p>Make sure that:</p> <p>The display device driver is installed correctly by doing the following:</p> <ol style="list-style-type: none"> <li>1. Click on <b>Start</b> and move the cursor to <b>Settings</b>, and <b>Control Panel</b>.</li> <li>2. Double-click on <b>Control Panel</b>, and then <b>Display</b>.</li> <li>3. Select the <b>Settings</b> tab.</li> <li>4. Click on <b>Advanced Properties</b>. The "Adapter/Driver Information" window appears. Make sure the display driver information in the window is correct.</li> </ol> <p>The refresh rate setting is set to your display resolution and color depth by doing the following:</p> <ol style="list-style-type: none"> <li>1. Start the ThinkPad Configuration program.</li> <li>2. Click on <b>LCD</b> (.</li> <li>3. (For Windows 95) Click on <b>Properties....</b> (For Windows NT) Click on <b>Advanced....</b></li> <li>4. Make sure that the setting in the next window is correct.</li> <li>5. Click on <b>OK</b>.</li> </ol>
Incorrect characters appear on the screen.	<p>Did you install the operating system or application program correctly?</p> <p>If they are installed and configured correctly, have the computer serviced.</p>
The screen stays on even after you power off your computer.	<p>Press the reset switch with the tip of a pen and turn off your computer; then turn it on again.</p>
Missing, discolored, or bright dots appear on the screen every time you power on your computer (TFT display model.)	<p>This is a characteristic of the TFT technology. Your computer display contains multiple thin-film transistors (TFTs). A small number of missing, discolored, or bright dots on the screen might exist all the time.</p>

## An Indicator Problem

Problem	Action
The battery status indicator does not go on even though a battery pack is installed in the computer.	The over-current protection device inside the battery pack has been activated. Wait several hours and try again. If the indicator still does not go on, replace the battery pack or have the computer serviced.

## Battery Problems

Problem	Action
The battery pack cannot be fully charged in 3.5 hours by the power-off charging method.	The battery pack might be over-discharged. Do the following: <ol style="list-style-type: none"> <li>1. Turn off the computer.</li> <li>2. Make sure that the over-discharged battery pack is in the computer.</li> <li>3. Connect the AC Adapter to the computer and let it charge.</li> </ol> If the battery pack cannot be fully charged in 24 hours, use a new battery pack.
Your computer shuts down before the battery status indicator shows empty. <i>-or-</i> Your computer operates after the battery status indicator shows empty.	Repeat discharging and charging the battery pack at least three times.
The computer does not operate with a fully charged battery pack.	The over-current protective function in the battery pack might be activated. Turn off the computer for 1 minute to reset this function; then turn it back on again.

## Troubleshooting Charts

### CD-ROM Drive Problems

Problem	Action
The CD-ROM does not work.	Make sure that: The computer power is turned on and a compact disc is in the CD-ROM drive. The CD-ROM drive tray is firmly closed. The device drivers are correctly installed.
You hear a noise from the CD-ROM drive when the CD-ROM is spinning.	The CD-ROM drive cover might be bent. Have the computer serviced.
The CD-ROM tray does not open even if you press the CD-ROM eject button.	Insert a pin into the CD-ROM emergency eject hole and eject the CD-ROM tray.
The compact disc cannot be read.	Make sure that: The compact disc is not dirty. If it is, clean it with a CD-ROM cleaner kit. The compact disc is not defective. If it is, try another compact disc. The compact disc is placed in the tray with the label side up. The compact disc format conforms with one of the following: <ul style="list-style-type: none"><li>- Music CD</li><li>- CD-ROM or CD-ROM XA</li><li>- Multisession photo CD</li><li>- Video CD</li></ul>

## Infrared Communication Problems

Problem	Action
<p>Your computer cannot communicate with other devices using the infrared port.</p>	<p>Make sure that:</p> <ul style="list-style-type: none"> <li>The communication speeds are the same.</li> <li>The infrared ports are clean.</li> <li>No objects are between the computer and the communicating device.</li> <li>The distance and angle between your computer and the device is within the set range.</li> <li>The other computer is the same model as yours.</li> <li>You are not operating under direct sunlight.</li> <li>The infrared ports are directly facing each other.</li> </ul> <p>Communication can be affected by the light from the display on the computer. To avoid this, open the display to a wide angle.</p> <p>The same communication application has to be running on your computer and the other computer. Refer to the application manuals for more information.</p> <p>ThinkPad mode cannot be used if you are using a conventional communication application that uses the serial port and cable for data exchange. (In this case, the infrared port is a substitute for them.)</p>
<p>Incorrect data is sent between your computer and a communicating device.</p>	<p>Make sure that:</p> <ul style="list-style-type: none"> <li>The distance and angle between your computer and the device is within the set range.</li> <li>The communication speeds are the same.</li> <li>There are no other devices that radiate infrared rays, such as remote-controlled devices or wireless headphones, near your computer or the communicating device.</li> <li>You are not operating under direct sunlight.</li> <li>No fluorescent lamps are near your computer or the communicating device.</li> </ul>
<p>You cannot use DMA channels for both the parallel port and the infrared port.</p>	<p>If you enable ECP and choose DMA3 (default value) for the parallel port, you might see the panel asking if you want to disable DMA for the infrared port. Do the following to use DMA channels for both parallel and infrared port:</p> <ol style="list-style-type: none"> <li>1. Click on <b>OK</b> to disable DMA for the infrared port.</li> <li>2. Close a parallel port panel.</li> <li>3. Click on the <b>Infrared device</b> button to open the infrared panel.</li> <li>4. Choose DMA0 or DMA1 for infrared port on the panel.</li> <li>5. If you see the panel prompting if you want to disable DMA for an audible device, click on <b>OK</b>.</li> </ol>

## Troubleshooting Charts

### An Audio or a Telephony Problem

Problem	Cause and Action
The volume of the WaveTable MidiSynth device cannot be controlled.	Use the <b>Serial-in</b> control in the volume control panel to control the volume.
The voice quality over the Voice-Over-Data communication is poor.	Due to limitations of the ThinkPad modem, the voice quality that is transmitted and received over the Voice-Over-Data communication is not as good as the normal telephone line. There may be momentary voice interruptions, delays, or distortions.
Other problems.	Problems may be due to such other factors as: <ul style="list-style-type: none"> <li>Incompatibility between the ThinkPad modem feature and other adapter cards in the docking station. To isolate this problem to a card or device, remove the adapter cards in the docking station one by one, and run the diagnostic test (see "Testing Your Computer" on page 144).</li> <li>The telephone cable configuration is not correct for your application.</li> <li>The telephone cable is defective.</li> <li>The telephone is defective.</li> <li>The audio cable configuration is not correct for your application.</li> <li>The audio cable is defective.</li> <li>The audio equipment is defective.</li> </ul>

### A Universal Serial Bus (USB) Problem

Problem	Cause and Action
A device connected to the USB connector does not work.	<ol style="list-style-type: none"> <li>1. Make sure that the USB device is connected correctly.</li> <li>2. Open the "Device Manager" window, and make sure that the USB device setup is correct, and that computer resource assignment and device driver installation are correct.</li> </ol> <p><b>Note:</b> To open the "Device Manager" window, click on <b>Start</b> and move the cursor to <b>Settings</b> and <b>Control Panel</b>. Double-click on <b>Control Panel</b> and <b>System</b>. Then click on the <b>Device Manager</b> tab in the "System Properties" window.</p> <p>Refer to "Testing Your Computer" on page 144 and run the diagnostic test for the USB connector.</p>

## A Modem Problem

Problem	Action
<p>Your modem application does not work with the ThinkPad modem.</p>	<p>Make sure that the internal modem port is enabled by opening the “Device Manager” window and running the <b>Modem Wizard</b> or by opening the ThinkPad Configuration program and doing as follows:</p> <ol style="list-style-type: none"> <li>1. Click on <b>Start</b>.</li> <li>2. Move the cursor to <b>Programs</b> and <b>ThinkPad</b>; then click on <b>ThinkPad Configuration</b>.</li> <li>3. Click on <b>Internal Modem</b> (.</li> <li>4. Select <b>Enable</b>.</li> <li>5. Click on <b>OK</b>.</li> </ol> <p><b>For Windows 95:</b></p> <p>If the modem does not work correctly, see the online book and correct the resource conflict.</p> <p>If the modem works correctly, set the following modem settings by doing the following:</p> <ol style="list-style-type: none"> <li>1. Double-click on <b>My Computer, Control Panel, and Modem</b>. The <b>OEM Mig 33.6 Data Fax VOD Modem</b> is highlighted.</li> <li>2. Click on <b>Properties, not Dialing Properties</b>.</li> <li>3. Click on the <b>Connection</b> tab.</li> <li>4. If there is a check mark ( <input checked="" type="checkbox"/> ) in the <b>Wait for dial tone before dialing</b> box, click and remove it.</li> <li>5. Click on <b>Advanced</b>.</li> <li>6. If there is a check mark ( <input checked="" type="checkbox"/> ) in the <b>Use error control</b> box, click and remove it.</li> <li>7. Add a check mark ( <input checked="" type="checkbox"/> ) to the <b>Use flow control</b> by clicking on the box and make sure that the <b>Hardware (RTS/CTS)</b> is selected.</li> <li>8. Click on <b>OK</b> to close the window.</li> <li>9. Click on <b>OK</b> and return to the “Modem Properties” window.</li> <li>10. Click on <b>Dialing Properties</b> and fill in all boxes and click on either <b>Tone dialing</b> or <b>Pulse dialing</b>.</li> </ol> <p><b>Note:</b> Most telephones today use tone dialing, where each button produces a different tone, instead of pulse dialing.</p> <ol style="list-style-type: none"> <li>11. Click on <b>OK</b>.</li> <li>12. Click on <b>Close</b> to close the window.</li> <li>13. Close all active windows.</li> </ol> <p>Run your modem application again.</p>

## Troubleshooting Charts

Problem	Action
The internal modem does not work when you start your computer from an operating system other than Windows 95.	<p>The operating system might be sharing the same IRQ levels as your modem. The ThinkPad modem software might not work under these conditions. You must cancel the IRQ shared condition to use the modem.</p> <p>To cancel the IRQ shared condition → Online book</p>

## PC Card Problems

Problem	Action
The PC Card shows "Ready," but it does not work correctly.	<p>Make sure that:</p> <ul style="list-style-type: none"> <li>The system resources reserved for the PC Card do not conflict with other system devices.</li> <li>Refer to "Resolving System Resource Conflicts" in the online book.</li> <li>The resources reserved for the PC Card match the settings in the application program.</li> <li>If you are using a modem card, check the COM number, I/O port address, and IRQ level. If you are using a network card, check the I/O port address, IRQ level, and memory window address. To check the resources assigned to the PC Card, click on <b>Status</b> in the PC Card Director program.</li> </ul>
A system resource conflict occurred when a PC Card was used.	See "Resolving System Resource Conflicts" in the online book.



Problem	Action
The system cannot start from the PC Card.	<p>To start from PC Card, do as follows:</p> <ol style="list-style-type: none"><li data-bbox="555 396 1043 426">1 Start the ThinkPad Configuration program.</li><li data-bbox="555 453 979 483">2 Click on the <b>UltraBay</b> () button.</li><li data-bbox="555 510 1342 573">3 Remove the check mark from the check box of the <b>Enable Hot/Warm Swapping of UltraBay</b>.</li><li data-bbox="555 599 724 630">4 Click on <b>OK</b>.</li></ol> <p>Make sure that the correct system resources are being used for the PC Card.</p> <p><b>ATA:</b>           IRQ 15                   I/O 170–177h, 376h                   <b>Note:</b> Secondary IDE should be disabled.</p> <p><b>RPL (Token Ring):</b> IRQ 9                   Memory: D6000–DBFFFh                   I/O A20–A23h</p> <p><b>RPL (Ethernet):</b> IRQ 5                   Memory D2000–D7FFFh                   I/O 300–31Fh</p>

## Troubleshooting Charts

Problem	Action
<p>Your PC Card modem does not work.</p>	<p>Make sure that the infrared port is disabled and the modem is set up correctly.</p> <p>Make sure that the COM port you set for modem by the ThinkPad Configuration program is same in the following procedure and there is no resource conflict.</p> <p><b>For Windows 95:</b></p> <p>To set up the modem, do the following:</p> <ol style="list-style-type: none"> <li>1. Click on <b>Start</b> and move the cursor to <b>Settings</b> and <b>Control Panel</b>.</li> <li>2. Double-click on <b>Modem</b>. The "Modem Properties" window appears.</li> <li>3. Make sure the PC Card (PCMCIA) modem is in the window.</li> <li>4. Click on <b>Properties</b>, <i>not</i> <b>Dialing Properties</b>.</li> <li>5. Click on the <b>Connection</b> tab.</li> <li>6. Remove the check mark ( ) in the <b>Wait for dial tone before dialing</b> box if it is checked.</li> <li>7. Click on <b>Advanced</b>.</li> <li>8. If there is a check mark ( ) in the <b>Use error control</b> box, click and remove it.</li> <li>9. Add a check mark ( ) to the <b>Use flow control</b> by clicking on the box and make sure that the <b>Hardware (RTS/CTS)</b> is selected.</li> <li>10. Close the window by clicking on <b>OK</b>.</li> <li>11. Return to the "Modem Properties" window by clicking on <b>OK</b>.</li> <li>12. Click on <b>Dialing Properties</b> in the "Modem Properties" window, and fill in all boxes.</li> </ol> <p><b>Note:</b> Click on either <b>Tone dialing</b> or <b>Pulse dialing</b>. Most telephones today use tone dialing.</p> <ol style="list-style-type: none"> <li>13. Click on <b>OK</b>.</li> <li>14. Click on <b>Close</b> to close the window.</li> <li>15. Close all active windows.</li> </ol> <p>Run your modem application again.</p>
<p>You cannot use PC Cards other than IBM ones in the OS/2 Warp environment.</p>	<p>If you do not have the PC Card device driver for OS/2 but you have one for DOS, your PC Card may run in the VDM (Virtual DOS machine) environment. Refer to the "Virtual Card Services" section in the online book for setting the VDM and the sample configuration files on the PCMCIA Installation Diskette for OS/2, Windows 95.</p> <p>If the PCMCIA Installation Diskette for OS/2, Windows 95 did not come with the computer, create it using the Diskette Factory program. Refer to "Using the Diskette Factory" on page 148.</p>

Problem	Action
PC Card support software does not recognize your PC Card.	<p>Make sure that:</p> <p>If the PC Card is not a modem, an ATA, a Flash, or an SRAM card, you have the proper client device driver for the card. In Windows 95, the PC Card must have an INF file associated with it.</p> <p>Your PC Card supports PCMCIA Release 2.0, 2.01, and 2.10. Refer to the manual that came with your PC Card. If your PC Card does not support those releases of PCMCIA, you cannot use PC Card Director. Contact your PC Card supplier.</p> <p>Your PC Card is working by following the diagnostic instructions for your PC Card, if any.</p>
The PC Card is recognized by PC Card support software, but the "Not Ready" or "Not Configured" message is shown.	<p>Make sure that:</p> <p>The PC Card enabler is installed. Refer to the manuals supplied with your PC Card.</p> <p>If the PC Card is not a modem, an ATA, a Flash, or an SRAM card, you must have the proper client device driver for the card. In Windows 95, the PC Card must have an INF file associated with it.</p> <p>The resources for the PC Card are correctly reserved. Refer to "Resolving System Resource Conflicts" in the online book.</p>

## Docking Station Problems

Problem	Action
The IDE CD-ROM drive or the hard disk drive in the docking station does not work.	<p>Make sure that the system resources of the secondary IDE device in the docking station do not conflict with the system resources of the other devices. Do the following:</p> <ol style="list-style-type: none"> <li>1. Click on <b>Start</b>.</li> <li>2. Move the cursor to <b>Programs</b> and <b>ThinkPad</b>; then click on <b>ThinkPad Configuration</b>.</li> <li>3. Click on <b>Docking Station</b>  and put a check mark ( <input checked="" type="checkbox"/> ) on <b>Enable IDE device in the docking station</b>.</li> </ol> <p><b>Note:</b> Do not use IRQ 11 and 15 for the PCI device setting.</p> <ol style="list-style-type: none"> <li>4. Click on <b>OK</b>.</li> </ol>



## Troubleshooting Charts

Problem	Action
The MIDI port of the port replicator does not work.	<p>To enable the MIDI port of the port replicator, use the ThinkPad Configuration program. Make sure that the MIDI port is enabled by doing the following:</p> <ol style="list-style-type: none"> <li>1. Start the ThinkPad Configuration program.</li> <li>2. Click on <b>MIDI Port</b>.</li> <li>3. Confirm that the MIDI port is enabled. If not, click on <b>Enable</b>; then click on <b>OK</b>.</li> <li>4. Close the ThinkPad Configuration program and restart the computer.</li> </ol> <p><b>Note:</b> When you restart the computer, you might need to install the MIDI driver. Follow the instructions on the screen and install the device driver for your computer's operating system.</p>

## A Printer Problem

Problem	Action
The printer does not work.	<p>Make sure that:</p> <p>The parallel port is enabled.</p> <ol style="list-style-type: none"> <li>1. Start the ThinkPad Configuration program.</li> <li>2. Click on <b>Parallel Port</b> (.</li> <li>3. Select <b>Enable</b>.</li> <li>4. Click on <b>OK</b>.</li> </ol> <p>The printer is turned on and ready to print. The printer signal cable is connected to the correct connector of your computer.</p> <p>If these items are correct and the printer still does not work, run the tests described in the printer manual. If the tests show that the printer is OK, have the computer serviced.</p>

## External Monitor Problems

Problem	Action
<p>The external monitor is blank.</p>	<p>Do the following:</p> <ol style="list-style-type: none"> <li>1. Connect the external monitor to another computer to make sure it works.</li> <li>2. Reconnect the external monitor to your computer.</li> <li>3. Start the ThinkPad Configuration program.</li> <li>4. Click on <b>External Display</b> () or <b>LCD + External Display</b> () on the toolbar in the ThinkPad Configuration program.</li> </ol> <p>If nothing appears on the external monitor, have the computer serviced.</p>
<p>You cannot set a higher resolution than the present one on your external monitor.</p>	<p>Make sure that:</p> <p>The ThinkPad display driver is installed correctly.</p> <ol style="list-style-type: none"> <li>1. Click on <b>Start</b> and move the cursor to <b>Settings</b> and <b>Control Panel</b>.</li> <li>2. Double-click on <b>Display</b>.</li> <li>3. Select the <b>Settings</b> tab in the "Display Properties" window.</li> <li>4. (Windows 95) Click on <b>Advanced Properties</b>. (Windows NT) Click on <b>Display Type...</b></li> </ol> <p>The "Adapter/Driver Information" window appears. Make sure that the ThinkPad display driver is installed.</p> <p>If you are not sure that the ThinkPad display driver is installed correctly, reinstall it.</p> <p>An appropriate display type or refresh rate is selected.</p> <ol style="list-style-type: none"> <li>1. Start the ThinkPad Configuration program.</li> <li>2. Click on <b>LCD</b> ()</li> <li>3. (For Windows 95) Click on <b>Properties...</b> (For Windows NT) Click on <b>Advanced...</b></li> <li>4. Make sure the setting in the next window is correct.</li> <li>5. Click on <b>OK</b> to close the window.</li> </ol>



## Troubleshooting Charts

Problem	Action
The screen is unreadable or distorted.	<p>Make sure that:</p> <p>The ThinkPad display driver is installed correctly by doing the following:</p> <ol style="list-style-type: none"> <li>1. Click on <b>Start</b> and move the cursor to <b>Settings</b> and <b>Control Panel</b>.</li> <li>2. Double-click on <b>Display</b>.</li> <li>3. Select the <b>Settings</b> tab in the "Display Properties" window.</li> <li>4. (Windows 95)Click on <b>Advanced Properties</b>. (Windows 95)Click on <b>Display Type....</b> The "Adapter/Driver Information" window appears. Make sure that the ThinkPad display driver is installed.</li> </ol> <p>The display is set correctly.</p> <ol style="list-style-type: none"> <li>1. Start the ThinkPad Configuration program.</li> <li>2. Click on <b>LCD</b> (.</li> <li>3. (For Windows 95) Click on <b>Properties....</b> (For Windows NT) Click on <b>Advanced....</b></li> <li>4. Make sure the setting in the next window is correct.</li> <li>5. Click on <b>OK</b> to close the window.</li> </ol> <p>If the settings are correct, run the tests described in the manual supplied with the external monitor. If the tests show that the external monitor is OK, have the computer serviced.</p>
Wrong characters appear on the screen.	<p>Did you install the operating system or application program with the correct procedure?</p> <p>If you did, have the external monitor serviced.</p>

## Port Replicator Problems

Problem	Action
The computer hangs when you power on or resume operation.	<p>Make sure that the computer is securely attached to the port replicator.</p> <p>If there is still a problem, have the port replicator serviced.</p>

## Other Option Problems

Problem	Action
An IBM option that you just installed does not work.	<p>Make sure that:</p> <ul style="list-style-type: none"> <li>The option is designed for your computer.</li> <li>The option was installed following the instructions supplied with the option or this book.</li> <li>Other installed options or cables are not loose.</li> <li>There is no I/O address or interrupt level (IRQ) DMA channel conflict. To see the system resource status, start the ThinkPad Configuration program and click on the respective device buttons.</li> </ul> <p>If the test program for the option did not find the problem, have the computer and option serviced.</p>
An IBM option that used to work no longer works.	<p>Make sure that:</p> <ul style="list-style-type: none"> <li>The option is securely connected to your computer.</li> <li>If the option came with its own test instructions, use those instructions to test the option.</li> <li>There is no system resource conflict (see "Resolving System Resource Conflicts" in the online book).</li> </ul> <p>If these items are correct and the test program did not find the problem, have the computer and option serviced.</p>
The serial port does not work.	<p>Make sure that the serial port is enabled by doing the following:</p> <p><b>For Windows 95:</b></p> <ol style="list-style-type: none"> <li>1. Start the ThinkPad Configuration program.</li> <li>2. Click on <b>Serial Port</b> (.</li> <li>3. Select <b>Enable</b>.</li> <li>4. Click on <b>Device Manager</b>.</li> <li>5. Set up the port in the "Device Manager" window.</li> <li>6. Click on <b>OK</b>.</li> </ol> <p><b>For Windows NT:</b></p> <ol style="list-style-type: none"> <li>1. Start the ThinkPad Configuration program.</li> <li>2. Click on <b>Serial Port</b> (.</li> <li>3. Select <b>Enable</b>; then select <b>COM1, COM2, COM3, or COM4</b>.</li> <li>4. Click on <b>OK</b>.</li> </ol>

## Troubleshooting Charts

### Software Problems

Problem	Action
An application does not run correctly.	<p>Check the following to make sure that the problem is not being caused by the application:</p> <ul style="list-style-type: none"> <li>Your computer has the minimum required memory to run the application. Refer to the manuals supplied with the application.</li> <li>The application is designed to operate with your operating system.</li> <li>Other applications run correctly on your computer.</li> <li>The necessary device drivers are installed. → Online book</li> <li>The application works OK when it is run on some other computer.</li> </ul> <p>If an error message appears when you are using the application program, refer to the manuals supplied with the application.</p> <p>If these items are correct and you still have a problem, contact your place of purchase or the service representative for help.</p>
You cannot install OS/2 Warp.	See the online book.

### Other Problems

Problem	Cause or Action
The computer locks or does not accept any input.	<p>Your computer might lock when it enters suspend mode during a communication operation. Disable the Suspend Timer when you are working on the network.</p> <p>When you turn on the computer with OS/2 Warp installed, make sure no compact disc (CD) is in the CD-ROM drive. If there is, remove the CD, turn off the computer, and turn it on again.</p> <p>To turn off the computer, press the reset switch using the tip of a ballpoint pen.</p>
The computer does not turn off with the power switch.	<p>If the suspend indicator is on and you are working under battery power, change the battery to a fully charged one or change your power source to ac power.</p> <p>If you still have a problem, press the reset switch using the tip of a ballpoint pen.</p>
The computer does not start from a diskette.	Make sure that the startup sequence in Easy-Setup is set so that the computer starts up from the diskette drive (see page 19).



<b>Problem</b>	<b>Cause or Action</b>
Performance degrades when the computer gets hot during use.	The processor speed might decrease under the following conditions: Use in a hot environment High-powered processing that requires high-power consumption  This is not a defect.
A memory shortage or memory error occurs.	If you are using DOS: <ol style="list-style-type: none"><li>1. Use the DOS command MEM /C to review your DOS memory usage occasionally.</li><li>2. Unload any unnecessary drivers from the CONFIG.SYS file. (For example, unload printer drivers if you do not use a printer.)</li><li>3. Reconfigure the UMB (upper memory block) using the DEVICEHIGH statement.</li><li>4. Use the multiple configuration setup for DOS (refer to the documents supplied with DOS).</li></ol> If you are using Windows 3.11: <ol style="list-style-type: none"><li>1. Try the same actions as described for DOS.</li><li>2. Unload any unnecessary programs from the WIN.INI file (for example, FUELWIN for ac operations.)</li></ol>



## Testing Your Computer



# Testing Your Computer

If you still have a problem with your computer after using the Troubleshooting Charts, test the computer using the Easy-Setup **Test** function.

To test your computer, do the following:

- 1 Press and hold **F1**; then turn on the computer to start Easy-Setup. Hold **F1** until the “Easy-Setup” menu appears:

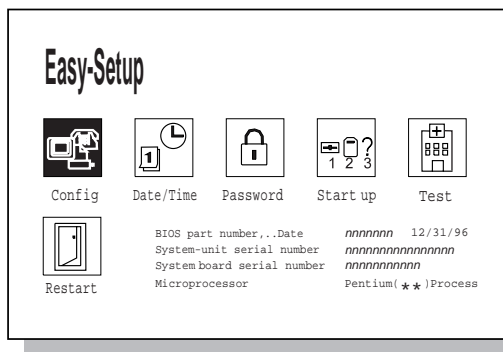

You will hear a short beep. If you are not sure whether you heard a beep, press **Fn+PgUp** a few times to make the speaker volume loud. Turn off the computer and try again. If you still don't hear a beep, the speaker is not working. Have your computer serviced.



**2** Select the **Test** icon; then select the **Start** icon or press **Enter**.

**Note:** Do not touch the keyboard or the pointing device during the test.

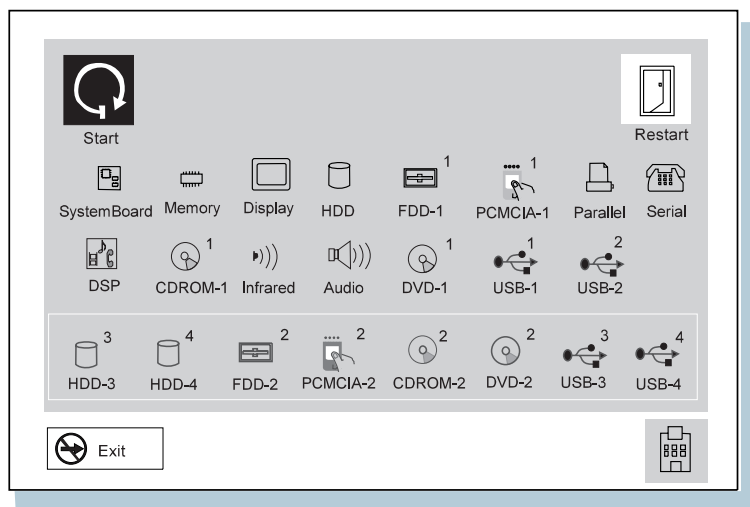

If you cannot go to the next menu, have the computer serviced.

If an X appears to the left of a device with an error code below it, make a note of the error code and have the computer serviced.

## *Testing Your Computer*

### **Test the SelectaDock I and II**

You need to create the diagnostic diskette to test the SelectaDock docking station. This diskette replaces the diagnostic portion of existing SelectaDock I or SelectaDock II Option Diskette. Use this diskette to test SelectaDock I or II instead of the existing option diskettes. Create the diagnostic diskette as follows:

- 1** Create the SelectaDock I/II Diagnostic Diskette, using the Diskette Factory program preinstalled on the hard disk.
- 2** Connect your ThinkPad to SelectaDock I or II.
- 3** Start from SelectaDock I/II Diagnostic Diskette.  
Follow the instructions on the screen.

## Recovering Lost or Damaged Software

This section describes how to recover lost or damaged software. The following table shows what is needed to recover your system.

Problem	Tools Provided	For More Information
<b>Windows 95 and Windows NT users with a CD-ROM drive</b>		
You need to recover a lost or damaged device driver.	Use the ThinkPad Installer on the ThinkPad Customization CD.	See "Using the ThinkPad Customization CD" on page 149 for general information. The CD-ROM also contains online help for detailed instructions.
You need to recover (reinstall) a lost or damaged software application.	Use the Easy Application Installer on the ThinkPad Customization CD.	See "Using the ThinkPad Customization CD" on page 149 for general information. The CD-ROM also contains online help for detailed instructions.
You need to recover your entire hard disk.	Use the ThinkPad Recovery CD (Windows 95 only).	See "Using the Recovery CD" on page 150 for general information.
<b>Windows 95 or Windows NT users without a CD-ROM drive</b>		
You need to recover a lost or damaged device driver.	Use the Diskette Factory on your hard disk drive.	See "Using the Diskette Factory" on page 148 for general information about using Diskette Factory.
You need to recover (reinstall) a lost or damaged software application.	Use the Diskette Factory on your hard disk drive. <b>Note:</b> Some applications are not supported in Diskette Factory.	See "Using the Diskette Factory" on page 148 for general information about using Diskette Factory.

## Recovering Lost or Damaged Software

Problem	Tools Provided	For More Information
You need to recover your entire hard disk drive.	Contact Microsoft for operating system installation diskettes.  Go to the ThinkPad Web site to download latest hardware driver diskettes. Install them.  —Or— Get your computer serviced by IBM. Some charge might apply.	See the Microsoft Windows booklet shipped with your computer to find out how to order Windows installation diskettes.  —Or— See Chapter 5, "Getting Service" on page 153.
<b>OS/2 or Windows 3.1 users</b>		
You need to recover a lost or damaged device driver.	Go to the ThinkPad Web site to download the latest hardware device driver diskettes. Install them.	See the online book for how to install the device driver.

## Using the Diskette Factory

To recover a particular device driver or utility program, create the backup diskettes for it with the Diskette Factory; then reinstall it.

To create the backup diskettes, do the following:

- 1** Click on **Start**.
- 2** Move the cursor to **Programs** and **ThinkPad**; then click on **Diskette Factory**.
- 3** Click on the tab at the top corresponding to the operating system you are using.
- 4** Click on the diskette group for the backup copy that you want to make.

**Notes:**

1. You can select more than one group by clicking while pressing **Ctrl**.
2. The number of the diskettes required is shown beside the diskette group. You do not need to use a blank diskette; the Diskette Factory prompts you to reformat diskettes that are not blank.

**5** Click on **Build**.

**6** Follow the instructions on the screen.

For detail on how to install software → “Advanced” in the online book.

## Using the ThinkPad Customization CD

The ThinkPad Customization CD is provided for your installation convenience. If you need to reinstall a software application or a hardware device driver, put the ThinkPad Customization CD in your CD-ROM drive. The menu of the features appears automatically. The following features are included:

### **Software Select Installer (Windows 95 and Windows NT 4.0)**

If you are using Windows 95 or Windows NT 4.0, click on this button to learn about and reinstall any of the ThinkPad software applications that you want. You will be guided through the installation process.

### **ThinkPad RTC Installer**

Use this program to reinstall or create diskettes of any software application or hardware device driver. This is the fastest way to install a lot of applications and device drivers. This program is designed for the system administrator.

### **Online User's Guide**

In case you do not have the online user's guide on your hard disk drive, you always have a copy on your ThinkPad Customization CD. Read “Advanced” in the online book for more information.

### **CD-ROM Help**

This contains an overview of CD-ROM functions.

## Recovering Lost or Damaged Software

### Using the Recovery CD

You can restore the contents of your hard disk to what it was at the time of purchase.

#### Attention

This recovery program deletes all personal data and your customized configuration settings. It resets your computer to most of the factory-shipped default values. Be sure to back up your personal files before you use this CD.

The Recovery CD package consists of a startable diskette and a CD-ROM containing the original preinstalled image.

The recovery process might take up to 2 hours.

If you have a CD-ROM drive installed in your computer's UltralimBay and you don't have an external diskette drive attached, go to "Case 1."

If you have a CD-ROM drive installed in your computer's UltralimBay and you do have an external diskette drive attached, go to "Case 2" on page 152.

If you have a diskette drive installed in your computer's UltralimBay, replace it with the CD-ROM drive (see "Replacing the UltralimBay Device" on page 57). Then go to "Case 1."

**Case 1:** Your computer supports startable CDs when the startable CD function is enabled. To use Recovery CD, enable this function; then recover the system:

- 1** Power off the computer.
- 2** Insert the Recovery CD into the CD-ROM drive.
- 3** Power on your computer while pressing and holding the **F1** key.  
Hold the **F1** key until the Easy-Setup window appears.
- 4** Click on **Start up**.



**5** Click on **Power-on**.

**6** Click on **Reset**.

**7** Click on **CDROM**.

**8** Click on **OK**.

**9** Click on **Exit**.

The startable CD-ROM function is enabled.

**10** Click on **Restart** and then **OK**.

The computer restarts.

**11** Follow the instructions on the screen.

**12** When a completion message appears, remove the Recovery CD from the CD-ROM drive.

**13** Power off the computer.

**14** Power on your computer while pressing and holding the **F1** key.

Hold the **F1** key until the Easy-Setup window appears.

**15** Click on **Start up**.

**16** Click on **Power-on**.

**17** Click on **Reset**.

**18** Set the startup device and then click on **OK**.

**19** Click on **Exit**.

**20** Click on **Restart** and then **OK**.

Your computer restarts with the preinstalled configuration.

## ***Recovering Lost or Damaged Software***

### *Case 2*

- 1** Power off the computer.
- 2** Insert the Recovery CD Boot Diskette in the diskette drive.
- 3** Power on your computer.
- 4** Insert the Recovery CD into the CD-ROM drive.
- 5** Follow the instructions on the screen..

**Note:** The recovery program on the boot diskette includes drivers to support many devices such as the external CD-ROM, docking station, and the hard disk drive. Choose an appropriate option. You are prompted if a user intervention is required.

- 6** When a completion message appears, remove the Recovery CD Boot diskette from the diskette drive.
- 7** Press **Restart**  
Your computer restarts with the preinstalled configuration.

## Chapter 5. Getting Service

If you need further assistance, you can call your IBM reseller or IBM marketing representative.

You will need to know the following information when requesting repair service:

- Identification number of your computer
- Options installed in your system

**Note:** Use the record sheet on page 154.

- Error message or problem

**Note:** Error messages can help identify which service action is required and help the service representative provide quick and efficient service.

Use the record sheet on page 155.

### About Your Warranty

During the warranty period, you might be responsible for repair costs if the product damage was due to misuse, accident, modification, unsuitable physical or operating environment, or improper maintenance.

For full information on product warranties, see Appendix B.

For your convenience, write the service phone numbers here:

---

---

---

---



## Information on Your Computer



# Information on Your Computer

## Option List

DIMM

\_\_\_\_ MB  
\_\_\_\_ MB

PC Cards

\_\_\_\_\_  
\_\_\_\_\_

\_\_\_\_ MB Hard Disk Drive  
External Diskette Drive

Battery Pack

## Identification Numbers

The serial number label is on the bottom of your computer. Write down the machine **Type** and the serial number (**S/N**) in the following box:

IBM Product Name	ThinkPad 600
Machine Type	2645- _____
Serial Number	_____

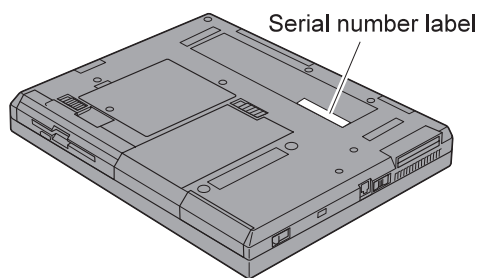



## Problem Recording Sheet

Computer information:

Machine type: \_\_\_\_\_

Serial number: \_\_\_\_\_

Date of purchase: \_\_\_/\_\_\_/\_\_\_

Type of problem:

Continuous problem

Intermittent problem

Error code:

\_\_\_\_\_

The operating system and its version number, if available:

OS/2 Version \_\_\_\_\_

DOS Version \_\_\_\_\_

Windows 95 Version \_\_\_\_\_

Windows 3.1

Windows NT Version \_\_\_\_\_

Application programs running at the time of the problem:

\_\_\_\_\_  
\_\_\_\_\_

Problem symptom:

Describe the problem specifically:

\_\_\_\_\_  
\_\_\_\_\_  
\_\_\_\_\_

Can the problem be reproduced?

Yes      No

If yes, describe how it can be reproduced:

\_\_\_\_\_  
\_\_\_\_\_



## **Customer Support and Service**

# **Customer Support and Service**

Purchasing an IBM PC hardware product entitles you to receive support and services during the limited warranty period. If you need additional support and services, a wide variety of extended solutions that addresses most needs are available for purchase.

## **Help by Telephone**

You can get support and information by telephone during the limited warranty period at no additional charge, through the IBM PC Support Line. Experienced technical-support representatives will be on hand to assist you in answering any questions you might have, such as:

- How to set up your computer
- How to install and set up your IBM options purchased directly from IBM or through an IBM reseller
- How to use the 30-day support for the preinstalled operating system
- How to get service

Please have the following information ready when you call:

- Serial number of your computer and proof of purchase
- Description of the problem
- Exact wording of the error message
- Hardware and software configuration information for your system

If possible, be at your computer when you call:

- In the U.S. and Puerto Rico, call 1-800-772-2227.
- In Canada, call 1-800-565-3344.

These lines are available 24 hours a day, 7 days a week. The answering technical-support representative can also fax or mail you technical or product information, such as:

- Sales information
- Product brochures
- Location of IBM resellers
- Services available from IBM

## ThinkPad EasyServ

ThinkPad *EasyServ* is a courier repair service for IBM mobile products whereby your ThinkPad computer will be picked up, sent to IBM for repair, and then returned to the location of your choice. This service is available at no additional charge during the limited warranty period. Most computers can be repaired the day that they arrive at the IBM repair location.

Support personnel first try to solve your problem over the phone. If they are unsuccessful, you can arrange for EasyServ service by calling the PC Support Line.

If possible, you should use the original ThinkPad shipping materials that your computer came in for resending it to IBM. If the box is not available, the courier will deliver a shipping carton and will return later to pick it up. This service is available only in the U.S. and Canada.

## Getting Help around the World

If you make frequent overseas trips or you are residing abroad, you can register with the International Warranty Service Office. The office will issue an International Warranty Service Certificate, which you can use wherever IBM or IBM resellers sell and service IBM PC products.

For more information on registering with the International Warranty Service Office, call 1-800-497-7426 in the U.S. or Canada.

## Fax Information

In the U.S. and Canada, if you have a touch-tone telephone and access to a fax machine, you can receive marketing and technical information on such topics as computer hardware, operating systems, and local area networks (LANs) by fax. You can call the IBM Automated Fax System 24 hours a day, 7 days a week. Follow the recorded instructions, and the information that you request will be sent your fax machine.

## **Customer Support and Service**

To access the IBM Automated Fax System, call:

In the U.S., 1-800-426-3395

In Canada, 1-800-465-3299

## **Electronic Support Services**

If you have a modem, you can access such public information services as the electronic bulletin boards and messaging areas, electronic conferences, and searchable databases available in several of the most popular online information services.

Bulletin boards and online services contain information on many topics such as:

- PC user groups
- PC questions and answers
- OS/2 topics
- Problem solving
- Technical information
- Hardware and software configurations
- Networking

The IBM Bulletin Board System (BBS) can be reached 24 hours a day, 7 days a week. Modem speeds of up to 14400 baud are supported. Long-distance telephone charges may apply.

To access the BBS, call:

In the U.S., 1-919-517-0001

For Canada, call the center closest to you:

- 905-316-4255 (Markham; Ontario)
- 514-938-3022 (Montreal)
- 416-492-1823 (Toronto)
- 604-664-6466 (Vancouver)



Commercial online services that have information on IBM products are:

CompuServe:

Use the **GO** word **ThinkPad**.

Prodigy:

Use the **Jump** command; type **IBM** and select **PC Product Support**.

America Online:

Use the **Go to** keyword **IBM**.

You can also contact us on the Internet for answers to your technical support questions. If you link to our support home page, you can search for technical tips, download update drivers, and find out about many other things. You can visit the site at the following URL:

<http://www.pc.ibm.com/thinkpad>

Personalized Web-based PC support provides PC users easy access to online support, including a personalized IBM Web site tailored to their machine type, computing environment, and such individual interests as business applications or games. Once you set up a profile with IBM, you are thereafter greeted by name and presented targeted information selected specifically to meet your particular needs. For example, if you are a corporate ThinkPad user, you might receive information on Microsoft Windows NT and remote connectivity. You can also choose to receive proactive e-mail, alerting you to time-saving hints and tips and such product-specific updates as modem speed and BIOS files. Interactive Web-based forums are monitored around the clock by IBM specialists, complementing its support on all the major Internet service providers. You can set up your profile at:

<http://www.pc.ibm.com/support>

## **Customer Support and Service**

### **Purchasing Additional Services**

During and after the limited warranty period, you can purchase additional services, such as:

- Support for IBM and non-IBM hardware, operating systems, and application programs
- Network setup and configuration
- Upgraded or extended hardware repair services
- Custom installation

The availability of the service and its name might vary by country.

### **Enhanced PC Support Line**

Enhanced PC Support is available for desktop and mobile IBM computers that are not connected to a network. Technical support is provided for IBM computers and IBM or non-IBM options, operating systems, and application programs on the supported products list.

This service includes technical support for the following:

- Installing and configuring your out-of-warranty IBM computer
- Installing and configuring non-IBM options in IBM computers
- Assistance with the preloaded operating system
- Using selected application software and games
- Tuning performance, such as memory management
- Installing device drivers remotely
- Setting up and using multimedia devices
- Identifying system problems
- Interpreting documentation

You can purchase this service for a single incident or for multiple incidents. For more information about purchasing the Enhanced PC Support, see "Ordering Support Line Services" on page 162.

### **Client Support Line**

Client support is available to provide assistance with the following:

- Installation and configuration of clients
- Identification of system problems related to the client in a network environment
- Assistance with client network interface cards and options

You can purchase this service on a one-time basis (for a single incident).

## **Network and Server Support Line**

Network and Server Support includes all the features of the Enhanced PC Support Line and is available for simple and complex networks made up of IBM workstations and servers using major network operating systems. This line also supports the many popular non-IBM adapters and network interface cards.

This service includes technical support for the following:

- Installing and configuring client workstations and servers
- Identifying system problems and correcting problems on the client or the server
- Using IBM and non-IBM network operating systems
- Interpreting documentation

You can purchase this service for a single incident or for multiple incidents. For more information about purchasing Network and Server Support, see "Ordering Support Line Services" on page 162.

## **Customer Support and Service**

### **Ordering Support Line Services**

The Enhanced PC Support Line, Client Support Line, and Network and Server Support Line services are available for products on the Supported Products list.

To receive a Supported Products list,

In the U.S:

- Call 1-800-772-2227.
- Select the automated fax system option.
- Select the service for which you would like a Supported Products list:
  - For the Enhanced PC Support Line, select document 11682.
  - For the Network and Server Support Line, select document 11683.

In Canada:

- Call 1-800-465-7999 or 1-800-465-3299

In other countries, contact your IBM reseller or IBM marketing representative.

For more information on how to purchase the Support Line Services:

In the U.S.: call 1-800-772-2227.

In Canada: call 1-800-465-7999.

In other countries, contact your IBM reseller or IBM marketing representative.

## **Warranty and Repair Services**

You can upgrade your ThinkPad EasyServ/Customer Carry-In warranty services or extend their period of service.

Upgradable warranties for the U.S. include:

Overnight service option. You can upgrade your current warranty that provides ThinkPad EasyServ/Carry-in repair service. Your warranty provides ThinkPad EasyServ/Carry-in repair service.

You can also extend your period of warranty. The “Warranty and Repair Services” offers a ThinkPad EasyServ Maintenance Agreement.

For more information on warranty upgrades and extensions:

In the U.S.: call 1-800-426-7697.

In Canada: call 1-800-465-7999.

In other countries, contact your IBM reseller or IBM marketing representative.

## ***Obtaining IBM Operating System Updates***

# **Obtaining IBM Operating System Updates**

IBM provides update diskettes, called ServicePaks or corrective service diskettes (CSDs), to customers who report a DOS or an OS/2 problem for which there is or will be a corrective program.

## **Getting Update Diskettes**

You can obtain update diskettes from:

IBM Software Solutions Center (1-800-992-4777 for the U.S. and Canada)

An IBM authorized reseller or an IBM marketing representative

## **Ordering Publications**

Additional publications are available for purchase from IBM. For a list of publications available in your country:

In the U.S. and Puerto Rico: call IBM PC Books at 1-800-426-7282.

In Canada: call 1-800-465-1234.

In other countries, contact your IBM authorized reseller or IBM marketing representative.

# Appendix A. Features and Specifications

---

This appendix describes features and specifications for the computer. For more information, refer to the *Technical Reference* manual.

## Features

### Processor

Intel Pentium processor mobile module with MMX  
Intel Pentium II processor mobile module with MMX

### Memory

Built-in: 32 MB  
Option: Max. 160 MB

### Storage devices

2.5-inch hard disk drive

### Display

The color display uses TFT or HPA technology

Up to 1024 by 768 resolution on the LCD  
Up to 1024 by 768 resolution on the external monitor  
Brightness control or contrast control

### Keyboard

84-key, 85-key, or 89-key  
TrackPoint  
Fn key function

## Features

### External diskette drive

To get the best performance from your diskette drives, use high-quality diskettes (such as IBM diskettes) that meet or exceed the following standards:

#### **1-MB, 3.5-inch, unformatted diskette:**

- ANSI (American National Standards Institute) X3.137
- ISO (International Standards Organization) 8860
- ECMA (European Computer Manufacturers Association) 100

#### **2-MB, 3.5-inch, unformatted diskette:**

- ANSI X3.171
- ISO 9529
- ECMA 125

### External interface

Serial connector (EIA-RS232D)

Parallel connector (Centronics)

External input-device connector

External-monitor connector

External-diskette-drive connector

Expansion connector

PC Card slots (two Type I or Type II PC Cards, or one Type III PC Card)

Headphone jack

Microphone/line-in jack (supports a dynamic microphone or a self-battery-powered condenser microphone)

Infrared port

Universal Serial Bus (USB) connector

Telephone connector



# Specifications

## Size

Width: 300 mm (11.8 in.)  
Depth: 240 mm (9.4 in.)  
Height: 36.5 mm (1.4 in.)

## Environment

**Note:**

When you charge the battery pack, its temperature must be at least 10°C (50°F).

Temperature (at altitudes less than 2438 m [8000 ft]):

- Operating with no diskette: 5° to 35°C (41° to 95°F)
- Operating with a diskette: 10° to 35°C (50° to 95°F)
- Nonoperating: 5° to 43°C (41° to 109°F)

Relative humidity:

- Operating with no diskette in the drive: 8% to 95%
- Operating with a diskette in the drive: 8% to 80%

Maximum altitude: 3048 m (10,000 ft) in unpressurized conditions

- Maximum temperature at 3048 m (10,000 ft): 31.3°C (88° F)

## Heat output

Approximately 30 Kcal per hour

## Electrical (AC Adapter)

Sine-wave input, at 50 to 60 Hz, is required  
The input rating of the AC Adapter: 100–240 V ac, 50/60 Hz

## Lithium-ion battery pack

Nominal voltage: 10.8 V dc  
Capacity: 3.2 AH

## IBM Power Cords

## IBM Power Cords

IBM power cords for a specific country are usually available only in that country:

***For 2-pin power cords:***

IBM Power Cord Part Number	Used in These Countries
13H5273	Japan

***For 3-pin power cords:***

**Note**

The grounded adapter is required for full MPRII compliance.

IBM Power Cord Part Number	Used in These Countries
76H3514	Australia, New Zealand
75H3516	Canada, Thailand, U.S.
76H3518	Europe
76H3520	Denmark
76H3522	India, South Africa
76H3524	United Kingdom
76H3526	Japan
76H3528	Switzerland
76H3530	Italy
76H3532	Israel
76H3535	Korea

## Appendix B. Product Warranties and Notices

International Business Machines Corporation

Armonk, New York 10504

### Statement of Limited Warranty

*The warranties provided by IBM in this Statement of Limited Warranty apply only to Machines you originally purchase for your use, and not for resale, from IBM or an IBM authorized reseller. The term "Machine" means an IBM machine, its features, conversions, upgrades, elements, or accessories, or any combination of them. Machines are subject to these terms only if purchased in the United States or Puerto Rico, or Canada, and located in the country of purchase. If you have any questions, contact IBM or your reseller.*

**Machine:** IBM ThinkPad 600 computer except the Battery Pack

**Warranty Period\*:** Three Years

*\*Elements and accessories are warranted for three months. Contact your place of purchase for warranty service information.*

### Production Status

Each Machine is manufactured from new parts, or new and serviceable used parts (which perform like new parts). In some cases, the Machine may not be new and may have been previously installed. Regardless of the Machine's production status, IBM's warranty terms apply.

### The IBM Warranty

IBM warrants that each Machine 1) is free from defects in materials and workmanship and 2) conforms to IBM's Official Published Specifications. IBM calculates the expiration of the warranty period from the Machine's Date of Installation. The date on your receipt is the Date of Installation, unless IBM or your reseller informs you otherwise.

During the warranty period, IBM or your reseller will provide warranty service under the type of service designated for the Machine and will manage and install engineering changes that apply to the Machine. IBM or your reseller will specify the type of service.

For a feature, conversion, or upgrade, IBM or your reseller may require that the Machine on which it is installed be 1) the designated, serial-numbered Machine and 2) at an engineering-change level compatible with the feature, conversion, or upgrade. Some of these transactions (called "Net-Priced" transactions) may include additional parts and associated replacement parts that are provided on an exchange basis. All removed parts become the property of IBM and must be returned to IBM.

Replacement parts assume the remaining warranty of the parts they replace.

If a Machine does not function as warranted during the warranty period, IBM or your reseller will repair or replace it (with a Machine that is at least functionally equivalent) without charge. If IBM or your reseller is unable to do so, you may return it to your place of purchase and your money will be refunded.

If you transfer a Machine to another user, warranty service is available to that user for the remainder of the warranty period. You should give your proof of purchase and this Statement to that user.

### Warranty Service

To obtain warranty service for the Machine, you should contact your reseller or call IBM. In the United States, call IBM at **1-800-772-2227**. In Canada, call IBM at **1-800-565-3344**. You may be required to present proof of purchase.

Depending on the Machine, the service may be 1) a "Repair" service at your location (called "On-site") or at one of IBM's or a reseller's service locations (called "Carry-in") or 2) an "Exchange" service, either On-site or Carry-in.

When a type of service involves the exchange of a Machine or part, the item IBM or your reseller replaces becomes its property and the replacement becomes yours. The replacement may not be new, but will be in good working order and at least functionally equivalent to the item replaced.

It is your responsibility to:

1. obtain authorization from the owner (for example, your lessor) to have IBM or your reseller service a Machine that you do not own;
2. where applicable, before service is provided —
  - a) follow the problem determination, problem analysis, and service request procedures that IBM or your reseller provide,
  - b) secure all programs, data, and funds contained in a Machine,
  - c) inform IBM or your reseller of changes in a Machine's location, and

## Product Warranties

- d) for a Machine with exchange service, remove all features, parts, options, alterations, and attachments not under warranty service. Also, the Machine must be free of any legal obligations or restrictions that prevent its exchange; and
3. be responsible for loss of, or damage to, a Machine in transit when you are responsible for the transportation charges.

### Extent of Warranty

IBM does not warrant uninterrupted or error-free operation of a Machine.

Unless IBM specifies otherwise, IBM provides non-IBM machines on an "AS IS" basis. However, non-IBM manufacturers may provide their own warranties to you.

Misuse, accident, modification, unsuitable physical or operating environment, improper maintenance by you, removal of product labels or parts identification labels, or failure caused by a product for which IBM is not responsible may void the warranties.

THESE WARRANTIES REPLACE ALL OTHER WARRANTIES, EXPRESS OR IMPLIED, INCLUDING, BUT NOT LIMITED TO, THE IMPLIED WARRANTIES OF MERCHANTABILITY AND FITNESS FOR A PARTICULAR PURPOSE. HOWEVER, SOME LAWS DO NOT ALLOW THE EXCLUSION OF IMPLIED WARRANTIES. IF THESE LAWS APPLY, THEN ALL EXPRESS AND IMPLIED WARRANTIES ARE LIMITED IN DURATION TO THE WARRANTY PERIOD. NO WARRANTIES APPLY AFTER THAT PERIOD.

In Canada, warranties include both warranties and conditions.

Some jurisdictions do not allow limitations on how long an implied warranty lasts, so the above limitation may not apply to you.

### Limitation of Liability

Circumstances may arise where, because of a default on IBM's part (including fundamental breach) or other liability (including negligence and misrepresentation), you are entitled to recover damages from IBM. In each such instance, regardless of the basis on which you are entitled to claim damages, IBM is liable only for:

1. bodily injury (including death), and damage to real property and tangible personal property; and
2. the amount of any other actual loss or damage, up to the greater of \$100,000 or the charge for the Machine that is the subject of the claim.

Under no circumstances is IBM liable for any of the following:

1. third-party claims against you for losses or damages (other than those under the first item listed above);
2. loss of, or damage to, your records or data; or
3. economic consequential damages (including lost profits or savings) or incidental damages, even if IBM is informed of their possibility.

Some jurisdictions do not allow the exclusion or limitation of incidental or consequential damages, so the above limitation or exclusion may not apply to you.

This warranty gives you specific legal rights and you may also have other rights which vary from jurisdiction to jurisdiction.

## Product Warranties

International Business Machines Corporation

Armonk, New York 10504

### Statement of Limited Warranty

*The warranties provided by IBM in this Statement of Limited Warranty apply only to Machines you originally purchase for your use, and not for resale, from IBM or an IBM authorized reseller. The term "Machine" means an IBM machine, its features, conversions, upgrades, elements, or accessories, or any combination of them. Machines are subject to these terms only if purchased in the United States or Puerto Rico, or Canada, and located in the country of purchase. If you have any questions, contact IBM or your reseller.*

**Machine:** Battery Pack

**Warranty Period\*:** One Year

*\*Elements and accessories are warranted for three months. Contact your place of purchase for warranty service information.*

### Production Status

Each Machine is manufactured from new parts, or new and serviceable used parts (which perform like new parts). In some cases, the Machine may not be new and may have been previously installed. Regardless of the Machine's production status, IBM's warranty terms apply.

### The IBM Warranty

IBM warrants that each Machine 1) is free from defects in materials and workmanship and 2) conforms to IBM's Official Published Specifications. IBM calculates the expiration of the warranty period from the Machine's Date of Installation. The date on your receipt is the Date of Installation, unless IBM or your reseller informs you otherwise.

During the warranty period, IBM or your reseller will provide warranty service under the type of service designated for the Machine and will manage and install engineering changes that apply to the Machine. IBM or your reseller will specify the type of service.

For a feature, conversion, or upgrade, IBM or your reseller may require that the Machine on which it is installed be 1) the designated, serial-numbered Machine and 2) at an engineering-change level compatible with the feature, conversion, or upgrade. Some of these transactions (called "Net-Priced" transactions) may include additional parts and associated replacement parts that are provided on an exchange basis. All removed parts become the property of IBM and must be returned to IBM.

Replacement parts assume the remaining warranty of the parts they replace.

If a Machine does not function as warranted during the warranty period, IBM or your reseller will repair or replace it (with a Machine that is at least functionally equivalent) without charge. If IBM or your reseller is unable to do so, you may return it to your place of purchase and your money will be refunded.

If you transfer a Machine to another user, warranty service is available to that user for the remainder of the warranty period. You should give your proof of purchase and this Statement to that user.

### Warranty Service

To obtain warranty service for the Machine, you should contact your reseller or call IBM. In the United States, call IBM at **1-800-772-2227**. In Canada, call IBM at **1-800-565-3344**. You may be required to present proof of purchase.

Depending on the Machine, the service may be 1) a "Repair" service at your location (called "On-site") or at one of IBM's or a reseller's service locations (called "Carry-in") or 2) an "Exchange" service, either On-site or Carry-in.

When a type of service involves the exchange of a Machine or part, the item IBM or your reseller replaces becomes its property and the replacement becomes yours. The replacement may not be new, but will be in good working order and at least functionally equivalent to the item replaced.

It is your responsibility to:

1. obtain authorization from the owner (for example, your lessor) to have IBM or your reseller service a Machine that you do not own;
2. where applicable, before service is provided —
  - a) follow the problem determination, problem analysis, and service request procedures that IBM or your reseller provide,
  - b) secure all programs, data, and funds contained in a Machine,
  - c) inform IBM or your reseller of changes in a Machine's location, and

## Product Warranties

- d) for a Machine with exchange service, remove all features, parts, options, alterations, and attachments not under warranty service. Also, the Machine must be free of any legal obligations or restrictions that prevent its exchange; and
3. be responsible for loss of, or damage to, a Machine in transit when you are responsible for the transportation charges.

### Extent of Warranty

IBM does not warrant uninterrupted or error-free operation of a Machine.

Unless IBM specifies otherwise, IBM provides non-IBM machines on an "AS IS" basis. However, non-IBM manufacturers may provide their own warranties to you.

Misuse, accident, modification, unsuitable physical or operating environment, improper maintenance by you, removal of product labels or parts identification labels, or failure caused by a product for which IBM is not responsible may void the warranties.

THESE WARRANTIES REPLACE ALL OTHER WARRANTIES, EXPRESS OR IMPLIED, INCLUDING, BUT NOT LIMITED TO, THE IMPLIED WARRANTIES OF MERCHANTABILITY AND FITNESS FOR A PARTICULAR PURPOSE. HOWEVER, SOME LAWS DO NOT ALLOW THE EXCLUSION OF IMPLIED WARRANTIES. IF THESE LAWS APPLY, THEN ALL EXPRESS AND IMPLIED WARRANTIES ARE LIMITED IN DURATION TO THE WARRANTY PERIOD. NO WARRANTIES APPLY AFTER THAT PERIOD.

In Canada, warranties include both warranties and conditions.

Some jurisdictions do not allow limitations on how long an implied warranty lasts, so the above limitation may not apply to you.

### Limitation of Liability

Circumstances may arise where, because of a default on IBM's part (including fundamental breach) or other liability (including negligence and misrepresentation), you are entitled to recover damages from IBM. In each such instance, regardless of the basis on which you are entitled to claim damages, IBM is liable only for:

1. bodily injury (including death), and damage to real property and tangible personal property; and
2. the amount of any other actual loss or damage, up to the greater of \$100,000 or the charge for the Machine that is the subject of the claim.

Under no circumstances is IBM liable for any of the following:

1. third-party claims against you for losses or damages (other than those under the first item listed above);
2. loss of, or damage to, your records or data; or
3. economic consequential damages (including lost profits or savings) or incidental damages, even if IBM is informed of their possibility.

Some jurisdictions do not allow the exclusion or limitation of incidental or consequential damages, so the above limitation or exclusion may not apply to you.

This warranty gives you specific legal rights and you may also have other rights which vary from jurisdiction to jurisdiction.

## Notices

References in this publication to IBM products, programs, or services do not imply that IBM intends to make these available in all countries in which IBM operates. Any reference to an IBM product, program, or service is not intended to state or imply that only that IBM product, program, or service may be used. Any functionally equivalent product, program, or service that does not infringe any of the intellectual property rights of IBM may be used instead of the IBM product, program, or service. The evaluation and verification of operation in conjunction with other products, except those expressly designated by IBM, are the responsibility of the user.

IBM may have patents or pending patent applications covering subject matter in this document. The furnishing of this document does not give you any license to these patents. You can send license inquiries, in writing, to the IBM Director of Licensing, IBM Corporation, 500 Columbus Avenue, Thornwood, NY 10594, U.S.A.

## Trademarks

The following terms, in this publication, are trademarks of the IBM Corporation in the United States or other countries or both:

IBM	PS/2
MMPM/2	RediSafe
Multimedia Presentation Manager/2	ThinkPad
Operating System/2	TrackPoint
OS/2	WIN-OS/2
PC Card Director	

Microsoft, Windows, Windows NT, and the Windows 95 flag logo are trademarks or registered trademarks of the Microsoft Corporation.

Pentium and MMX are trademarks or registered trademarks of Intel Corporation in the U.S. and other countries.

Other company, product, and service names, which may be denoted by a double asterisk (\*\*), may be trademarks or service marks of others.

## Notices

# Electronic Emission Notice

## *Federal Communications Commission (FCC) Statement*

ThinkPad 600, 2645

This equipment has been tested and found to comply with the limits for a Class B digital device, pursuant to Part 15 of the FCC Rules. These limits are designed to provide reasonable protection against harmful interference in a residential installation. This equipment generates, uses, and can radiate radio frequency energy and, if not installed and used in accordance with the instructions, may cause harmful interference to radio communications. However, there is no guarantee that interference will not occur in a particular installation. If this equipment does cause harmful interference to radio or television reception, which can be determined by turning the equipment off and on, the user is encouraged to try to correct the interference by one or more of the following measures:

- Reorient or relocate the receiving antenna.
- Increase the separation between the equipment and receiver.
- Connect the equipment into an outlet on a circuit different from that to which the receiver is connected.
- Consult an IBM authorized dealer or service representative for help.

Properly shielded and grounded cables and connectors must be used in order to meet FCC emission limits. Proper cables and connectors are available from IBM authorized dealers. IBM is not responsible for any radio or television interference caused by unauthorized changes or modifications to this equipment. Unauthorized changes or modifications could void the user's authority to operate the equipment.

This device complies with Part 15 of the FCC Rules. Operation is subject to the following two conditions: (1) this device may not cause harmful interference, and (2) this device must accept any interference received, including interference that may cause undesired operation.

Responsible party:

International Business Machines Corporation  
Old Orchard Road  
Armonk, NY 10504  
Telephone 1-919-543-2193



***Canadian Department of Communications Compliance Statement***

This equipment does not exceed Class B limits per radio noise emissions for digital apparatus, set out in the Radio Interference Regulation of the Canadian Department of Communications.

***Avis de conformité aux normes du ministère des Communications du Canada***

Cet équipement ne dépasse pas les limites de Classe B d'émission de bruits radioélectriques pour les appareils numériques, telles que prescrites par le Règlement sur le brouillage radioélectrique établi par le ministère des Communications du Canada.

***European Community Directive Conformance Statement***

This product is in conformity with the protection requirements of EC Council Directive 89/336/EEC on the approximation of the laws of the Member States relating to electro-magnetic compatibility.

A declaration of Conformity with the requirements of the Directive has been signed by IBM United Kingdom Limited, PO BOX 30 Spango Valley Greenock Scotland PA160AH.

This product satisfies the Class B limits of EN 55022.

## Notices

### Telecommunication Notice

#### Federal Communications Commission (FCC) and Telephone Company Requirements (Part 68 of the FCC Rules)

1. The Telephone Consumer Protection Act of 1991 makes it unlawful for any person to use a computer or other electronic device to send any message via a telephone fax machine unless such message clearly contains in a margin at the top or bottom of each transmitted page or on the first page of the transmission, the date and time it is sent, and an identification of the business or other entity, or other individual sending the message and the telephone number of the sending machine or such business, other entity, or individual.

In order to program this information into your computer, you should be sure to follow the installation instructions for your fax software package.

2. The built-in modem is built into the ThinkPad computer. It complies with Part 68 of the FCC Rules. A label is affixed to the bottom of the computer that contains, among other things, the FCC registration number, USOC, and Ringer Equivalency Number (REN) for this equipment. If these numbers are requested, look at the label and provide this information to your telephone company.
3. The REN is useful to determine the quantity of devices you may connect to your telephone line and still have those devices ring when your number is called. In most, but not all, areas, the sum of the RENs of all devices should not exceed five (5.0). To be certain of the number of devices you may connect to your line, as determined by the REN, you should call your local telephone company to determine the maximum REN for your calling area.
4. If the built-in modem causes harm to the telephone network, the telephone company may discontinue your service temporarily. If possible, they will notify you in advance. But, if advance notice isn't practical, you will be notified as soon as possible. You will be advised of your right to file a complaint with the FCC.
5. Your telephone company may make changes in its facilities, equipment, operations, or procedures that could affect the proper operation of your equipment. If they do, you will be given advance notice so as to give you an opportunity to maintain uninterrupted service.
6. If you experience trouble with this built-in modem, contact your IBM Authorized Seller, or the IBM Corporation, 500 Columbus Avenue, Thornwood, NY 10594, 1-800-772-2227, for repair/warranty information. The telephone company may ask you to disconnect this equipment from

the network until the problem has been corrected, or until you are sure the equipment is not malfunctioning.

7. No customer repairs are possible to the modem. If you experience trouble with this equipment, contact your Authorized Seller or the IBM Corporation for information.
8. The modem may not be used on coin service provided by the telephone company. Connection to party lines is subject to state tariffs. Contact your state public utility commission or corporation commission for information.
9. When ordering network interface (NI) service from the Local Exchange Carrier, specify service arrangement USOC RJ11C.

### Fax Branding

The Telephone Consumer Protection Act of 1991 makes it unlawful for any person to use a computer or other electronic device, including fax machines, to send any message unless such message clearly contains in a margin at the top of or bottom of each transmitted page or on the first page of the transmission, the date and time it is sent and an identification of the business or other entity, or other individual sending the message and the telephone number of the sending machine or such business, other entity, or individual. (The telephone number provided may not be a 900 number or any other number for which charges exceed local or long-distance transmission charges.)

In order to program this information into your fax machine, follow the setup instructions for **RingCentral\*\***.

### Notice for Australia

The following notice applies when using the telephony functions:

FOR SAFETY REASONS, ONLY CONNECT AUSTEL  
PERMITTED OR CERTIFIED EQUIPMENT.

## Notices

### Industry Canada Requirements

#### *Notice*

The Industry Canada label identifies certified equipment. This certification means that the equipment meets certain telecommunications networks protective, operational, and safety requirements. The Department does not guarantee the equipment will operate to the user's satisfaction.

Before installing this equipment, users should ensure that it is permissible to be connected to the facilities of the local telecommunications company. The equipment must also be installed using an acceptable method of communication. In some cases, the company's inside wiring associated with a single line individual service may be extended by means of a certified connector assembly (telephone extension cord). The customer should be aware that compliance with the above conditions may not prevent degradation of service in some situations.

Repairs to certified equipment should be made by an authorized Canadian maintenance facility designated by the supplier. Any repairs or alterations made by the user to this equipment, or equipment malfunctions, may give the telecommunications company cause to request the user to disconnect the equipment.

Users should ensure for their own protection that the electrical ground connections of the power utility, telephone lines and internal metallic water pipe system, if present, are connected together. This precaution may be particularly important in rural areas.

#### *Caution*

Users should not attempt to make such connections themselves, but should contact the appropriate electric inspection authority, or electrician, as appropriate.

The **Ringer Equivalent Number** (REN:0.5) assigned to each terminal device provides an indication of the maximum number of terminals allowed to be connected to a telephone interface. The termination on an interface may consist of any combination of

devices subject only to the requirement that the sum of the Ringer Equivalence Number of all the devices does not exceed 5.

### Avis

L'étiquette du ministère de l'Industrie Canada identifie le matériel homologué. Cette étiquette certifie que le matériel est conforme à certaines normes de protection, d'exploitation et de sécurité des réseaux de télécommunications. Le Ministère n'assure toutefois pas que le matériel fonctionnera à la satisfaction de l'utilisateur.

Avant d'installer ce matériel, l'utilisateur doit s'assurer qu'il est permis de le raccorder aux installations de l'entreprise locale de télécommunication. Le matériel doit également être installé en suivant une méthode acceptée de raccordement. Dans certains cas, les fils intérieurs de l'entreprise utilisés pour un service individuel à ligne unique peuvent être prolongés au moyen d'un dispositif homologué de raccordement (cordon prolongateur téléphonique interne). L'abonné ne doit pas oublier qu'il est possible que la conformité aux conditions énoncées ci-dessus n'empêchent pas la dégradation du service dans certaines situations. Actuellement, les entreprises de télécommunication ne permettent pas que l'on raccorde leur matériel à des jacks d'abonné, sauf dans les cas précis prévus par les tarifs particuliers de ces entreprises.

Les réparations de matériel homologué doivent être effectuées par un centre d'entretien canadien autorisé désigné par le fournisseur. La compagnie de télécommunications peut demander à l'utilisateur de débrancher un appareil à la suite de réparations ou de modifications effectuées par l'utilisateur ou à cause de mauvais fonctionnement.

Pour sa propre protection, l'utilisateur doit s'assurer que tous les fils de mise à la terre de la source d'énergie électrique, des lignes téléphoniques et des canalisations d'eau métalliques, s'il y en a, sont raccordés ensemble. Cette précaution est particulièrement importante dans les régions rurales.

## Notices

### *Avertissement*

L'utilisateur ne doit pas tenter de faire ces raccordements lui-même; il doit avoir recours à un service d'inspection des installations électriques, ou à un électricien, selon le cas.

L'indice de charge (IC) assigné à chaque dispositif terminal indique, (REN:0.5), pour éviter toute surcharge, le pourcentage de la charge totale qui peut être raccordée à un circuit téléphonique bouclé utilisé par ce dispositif. La terminaison du circuit bouclé peut être constituée de n'importe quelle combinaison de dispositifs, pourvu que la somme des indices de charge de l'ensemble des dispositifs ne dépasse pas 5.

This glossary includes terms and definitions from the *IBM Dictionary of Computing* (New York: McGraw-Hill, 1994).

**ac.** Alternating current.

**ac power.** Power that is supplied to the computer through an electrical outlet.

**Advanced Power Management (APM).** A facility consisting of one or more layers of software that support power management in computers with power manageable hardware. The APM software interface allows applications, operating systems, device drivers, and the APM BIOS to work together to reduce power consumption, without reducing system performance.

**ANSI.** American National Standards Institute.

**APM.** Advanced Power Management.

**application program.** A program that performs specific tasks on your computer, such as word processing or creating spreadsheets.

**ASCII.** American National Standard Code for Information Interchange.

**ATA PC Card.** A PC Card with an AT attachment hard disk drive interface such as a storage device PC Card.

**AUTOEXEC.BAT.** A file that contains a startup procedure of DOS. Each time you start your system, DOS performs the commands that are stored in this file.

**backup copy.** A copy, usually of a file or group of files, that is kept in case the original file or files are unintentionally changed or destroyed.

**batch.** A process method in which a program or programs records with little or no operator action.

**BIOS (Basic Input/Output System).**

Microcode that contains such basic hardware operations as interactions with diskette drives, hard disk drives, and the keyboard.

**bitmap graphics.** (1) A form of graphics in which all points on the display are directly addressable. (2) In multimedia applications, a form of graphics in an area of computer memory or storage that can be displayed as an image.

**boot.** To prepare a computer system for operation by loading an operating system.

**bps.** Bits per second. In serial transmission, the instantaneous bit speed with which a device or channel transmits a character.

**bus.** A facility for transferring data between several devices located between two end points, only one device being able to transmit at a given moment.

**cache memory.** A special memory, smaller and faster than main memory, that is used to hold a copy of instructions and data in main memory that are likely to be needed next by the processor, and that have been obtained automatically from main memory.

**CD-i.** Compact disc-interactive.

**cold docking.** Docking the computer to the docking station when the computer is powered off.

**combination keys.** Keys that have specific functions when you hold them down at the same time.

**CONFIG.SYS.** A file that contains a group of commands to load installable device drivers and reserve space in system memory for information

## Glossary

processing. This file is referred to by DOS during system startup.

**configuration.** (1) The manner in which the hardware and software of an information processing system are organized and interconnected. (2) The physical and logical arrangement of devices and programs that make up a data processing system. (3) The devices and programs that make up a system, subsystem, or network.

**CRT.** Cathode ray tube display.

**device driver.** (1) A file that contains the code needed to use an attached device. Operating system loads device drivers for screens, (2) A program that enables a computer to communicate with a specific peripheral device—for example, a printer, a video disc player, or a CD drive. (3) A collection of subroutines that control the interface between I/O device adapters and processors.

**DIMM.** Dual inline memory module.

**directory.** A type of file containing the names and controlling information for other files or other directories.

**Diskette Factory.** The preload program for creating the installation diskettes of the device drivers and the operating system.

**DMA.** Direct memory access. The transfer of data between memory and input/output units without processor intervention.

**double-click.** To press and release a mouse button twice within a time frame defined by the user, without moving the pointer off the choice.

**DRAM.** Dynamic random access memory.

**DSP.** Digital signal processor.

**ECP.** Extended Capability Port.

**EDO DRAM.** Enhanced data output dynamic random access memory.

**EGA.** Enhanced graphics adapter.

**EIA.** Electronics Industries Association.

**EIA-232D.** An EIA interface standard that defines the physical, electronic, and functional characteristics of an interface line that connects a communication device and associated workstation. It uses a 25-pin connector and an unbalanced line voltage.

**EMS.** Expanded memory specification.

**FAQ.** Frequently asked questions.

**fax.** (1) Facsimile machine. (2) A transmitted document from a facsimile machine.

**FDD.** Floppy disk drive.

**fixed disk.** In personal computing, *fixed disk* is synonymous with *hard disk*.

**Flash memory.** Electrically rewritable storage.

**folder.** A file used to store and organize documents.

**fuel gauge.** An indicator on the screen that constantly shows the current power status of the battery pack.

**HHR.** Half-horizontal resolution.

**hibernation.** One of the power-saving methods that stores data and applications running in the computer's memory on the hard disk. During hibernation, the computer is automatically turned off to save power. When power is turned on again, the computer



immediately restores the same data and applications as when hibernation started, without restarting the operating system.

**high-resolution mode.** Video resolutions that are greater than 640 by 480 pels.

**hot docking.** Docking the computer to the docking station when the computer is powered on.

**HPA.** High performance addressing.

**icon.** A graphic symbol, displayed on a screen, that a user can point to with a pointing device such as a TrackPoint or mouse to select a particular function or software application.

**IDE.** Integrated device electronics.

**IR.** Infrared.

**ISA.** Industry standard architecture.

**ISO.** International Organization for Standardization.

**JEIDA.** Japan Electronics Industry Development Association.

**kilobyte (KB).** 1024 bytes.

**LAN.** Local area network.

**LCD.** Liquid crystal display.

**MCI.** Media Control Interface.

**megabyte (MB).** 1024 kilobytes. About 1 million bytes.

**memory.** Often referred to as random-access memory (RAM), measured in kilobytes (KB) or megabytes (MB) of information.

**MHz.** Megahertz.

**microcode.** One or more microinstructions used in a product as an

alternative to hard-wired circuitry to implement functions of a processor or other system component.

**MIDI.** Musical Instrument Digital Interface.

**modem.** A device that connects your computer to a telephone line, allowing it to communicate with another computer at another location.

**parallel port.** A port used to attach such devices as dot-matrix printers and input/output units; it transmits data 1 byte at a time.

**partial suspend mode.** A kind of suspend mode where only a part of the system components uses power.

**password.** A series of letters or numbers that you designate to restrict access to your computer.

**PC Card.** A card that is based on the PC Card standard.

**PCMCIA.** Personal Computer Memory Card International Association.

**pel.** Picture element.

**Personalization Editor.** A feature that helps you to identify your computer when identical computers are being used in your location, or to deter theft.

**picture element.** In computer graphics, the smallest element of a display surface that can be independently assigned color and intensity.

**pixel.** Picture element.

**pointing device.** An instrument, such as a mouse, TrackPoint, or joystick, that is used to move a pointer on the screen.

**pop-up menu.** On the display screen, a menu that emerges in an upward

## Glossary

direction from a particular point or line on a display screen.

**port replicator.** An option to expand the capabilities of the ThinkPad computer by providing additional PC Card slots and ports.

**POST.** Power-on self-test.

**power mode.** A mode of battery operation to conserve power. The ThinkPad computer has three power modes: high performance, automatic, and customize.

**prompt.** A visual or audible message sent by a program to request the user's response.

**PSTN.** Public-switched telephone network.

**pull-down menu.** On the display screen, a menu that emerges in a downward direction from a point or line at or near the top of the screen.

**reboot.** To restart all operations of the computer as if the power had just been turned on.

**resume.** To begin computer operations again from suspend mode.

**ROM.** Read-only memory.

**SDRAM.** Static dynamic random access memory.

**serial port.** A port used to attach such devices as display devices, letter-quality printers, modems, plotters, and such pointing devices as light pens and mice; it transmits data 1 bit at a time.

**suspend.** To stop all operations of the computer to reduce power drain and restrict access to the files.

**SVGA.** Super video graphics adapter.

**TFT.** Thin-film transistor.

**TrackPoint.** The built-in pointing device of the ThinkPad computer.

**TSRs.** Terminate-and-stay-resident programs, memory-resident programs that are loaded into memory and stay there so you can conveniently access them whenever you need to.

**UltraslimBay.** The ThinkPad 600 bay for installing either a CD-ROM drive or a diskette drive.

**USB.** Universal serial bus.

**vertical expansion.** A video display technique in character-display mode to fit video images on the whole LCD screen by adjusting the number of character dots vertically.

**VESA.** Video Electronics Standards Association.

**VGA.** Video graphics adapter, a video mode that produces up to 640-by-480 resolution.

**VSYNC.** Vertical synchronization frequency.

**warm docking.** Docking the computer to the docking station when the computer is in suspend or hibernation mode.

**XMS.** Extended memory specification.

**A**

America Online 159  
audio problem 132

**B**

backing up the system 32  
battery pack  
    location 5  
    maximizing the battery life 109  
    replacing 34  
battery problem 129  
battery status, location 7  
battery-pack latch, location 5  
brightness control, location 2  
built-in microphone, location 2  
bulletin boards 158

**C**

Caps Lock, location 7  
CD-ROM drive  
    installing 57  
    problem 130  
CD-ROM eject button, location 2  
changing display output location 68  
changing startup sequence 19  
cold docking 76  
CompuServe 159  
ConfigSafe 33  
corrective service diskette (CSD) 164

**D**

dealer locations 156  
diagnostic diskette 164  
DIMM 49  
diskette drive  
    attaching 61  
    removing 62  
Diskette Factory, using 148  
diskette standards 166  
display modes 70  
docking station

docking station (*continued*)  
    cold docking 76  
    docking 77  
    enabling the IDE device 81  
    hot docking 76  
    problem 137  
    resource conflict 80  
    undocking 79  
    warm docking 76

**E**

Easy-Setup 16  
    testing 144  
EasyServ 157  
electronic support 158  
emergency hole, location 2  
enclosure, using 62  
enhanced PC support line 160  
ergonomics information 40  
error codes 118  
error messages 118  
external monitor  
    attaching 67  
    connector, location 5  
    plug-and-play 109  
    problem 139  
    setting 108  
external-diskette-drive connector,  
    location 2  
external-input-device connector,  
    location 5

**F**

features 165  
fee, services 159  
Fn key 11  
    location 2

**H**

hard disk drive, install 55  
hard disk drive, location 2  
hard disk in-use, location 7

## Index

hard disk password 86  
     changing 92  
     removing 92  
 hardware features 5  
 hardware specifications 167  
 headphone jack, location 2  
 heat output, machine specifications 167  
 hibernation mode 12  
 hibernation problem 124  
 hints, tips, limitations 111  
 hot docking 76  
 humidity, machine specifications 167

**I**  
 identification numbers, recording 154  
 indicator problem 129  
 infrared port, location 2  
 infrared port, setting 106  
 infrared problem 131  
 input problem 123  
 input voltage 167  
 installing  
     device driver 110  
     operating system 110  
 internal speaker, location 2

**K**  
 keyboard functions  
     Fn key 11  
     numeric keypad 13  
     TrackPoint 8  
 keyboard, specifications 165  
 knowing configuration 17

**L**  
 LCD latch, location 2  
 LCD output switching 12  
 LCD problem 128

**M**  
 magnifying glass 47  
 mechanical lock 102  
 memory 53  
     cover, location 5  
     installing 49  
     removing 54  
     size 53  
     slot, location 5  
     specifications 165  
 microphone/line-in jack, location 2  
 microprocessor, specifications 165  
 modem port, location 5  
 modem problem 133  
 mute 12

**N**  
 Network and Server Support fee 161  
 notices and warranties, product 169  
 numeric keypad 13  
 numeric lock, location 7

**O**  
 online book 31  
 operating system, updating 163  
 option problem 141  
 options  
     docking station 76  
     hard disk drive, upgrade 55  
     input devices, attaching 63  
     memory, increase 49  
     PC Card, installing 72  
     port replicator 76  
     space saver keyboard 66

**P**  
 parallel connector, location 5  
 part numbers, power cords 168  
 password  
     changing 92  
     entering 87

- password (*continued*)
    - removing 92
    - setting 88
    - using 86
  - PC Card
    - device driver, installing 74
    - installing 72
    - problem 134
    - removing 75
    - stopping 75
    - supported PC Card 72
  - PC Card eject button, location 2
  - Personalization Editor
    - deleting 101
    - setting 98
  - port replicator problem 140
  - power cords 168
  - power jack, location 5
  - power mode switching 12
  - power shutdown switch, location 5
  - power switch, location 5
  - power-on lamp, location 5
  - power-on password 86
    - changing 92
    - removing 92
  - press-to-select 44
  - printer problem 138
  - Prodigy 159
  - publications, ordering 164
- R**
- Recovery CD, using 150
  - removing a PC Card 75
  - repair services 164
    - getting service 164
    - identification numbers 154
  - resource conflict 80
- S**
- safety notice xiii
  - sales information 156
  - screen image, for DOS 70
  - Scroll Lock, location 7
  - scrolling 47
  - security
    - mechanical lock 102
    - passwords 86
    - Personalization Editor 98
  - security keyhole, location 5
  - sensitivity 46
  - serial connector, location 5
  - serial number 154
  - serial port, setting 106
  - service 164
    - how to get 164
  - ServicePak 164
  - setting date and time 18
  - size, machine specifications 167
  - software problem 142
  - software select installer 149
  - space save keyboard, using 66
  - specifications 165
    - battery pack 167
    - heat output 167
    - humidity, environment 167
    - input voltage 167
    - power cords 168
    - size 167
    - temperature, environment 167
  - standards, diskette 166
  - standby mode 12
  - supervisor password 86
    - changing 94
    - removing 94
  - suspend lamp, location 5
  - suspend mode 12
  - SVGA output 70
  - system-expansion connector, location 5
  - system-status indicator 7
- T**
- technical support 156
    - fee 159
  - telephone assistance 156
  - temperature, machine
    - specifications 167
  - testing 144

## Index

- ThinkPad Configuration program
    - for DOS 29
    - for OS/2 26
    - for Windows 3.1 26
    - for Windows 95 24
    - for Windows NT 26
    - infrared port, setting 106
    - serial port, setting 106
    - starting 104
    - TrackPoint, setting 107
  - ThinkPad Customization CD, using 149
  - ThinkPad EasyServ 163
  - ThinkPad RTC installer 149
  - ThinkPad utilities 16
    - Easy-Setup 16
    - ThinkPad Configuration program 24
  - TrackPoint 8
    - changing the cap 10
    - disable 66
    - location 2
    - magnifying glass 47
    - press-to-select 44
    - scrolling 47
    - sensitivity 46
    - setting 107
  - troubleshooting
    - audio problem 132
    - battery problem 129
    - CD-ROM problem 130
    - charts 117
    - docking station problem 137
    - error codes 118
    - error messages 118
    - external monitor problem 139
    - guide 116
    - hibernation problem 124
    - indicator problem 129
    - infrared problem 131
    - input problem 123
    - LCD problem 128
    - modem problem 133
    - no error code 122
    - no error message 122
    - option problem 141
    - other problem 142
    - troubleshooting (*continued*)
      - PC Card problem 134
      - port replicator problem 140
      - printer problem 138
      - recovering the system 116
      - software problem 142
      - testing 144
      - USB problem 132
- ## U
- UltraslimBay 15
  - UltraslimBay device lock, location 5
  - UltraslimBay device, replacing 57
  - updating, operating system 163
  - USB connector, location 5
  - USB problem 132
- ## V
- volume 12
- ## W
- warm docking 76
  - warm swap 57
  - warranty
    - extensions and upgrades 163
    - product 169
    - service, international 157





# IBM

Part Number: 05L2160

Printed in the United States of America

5L216

