

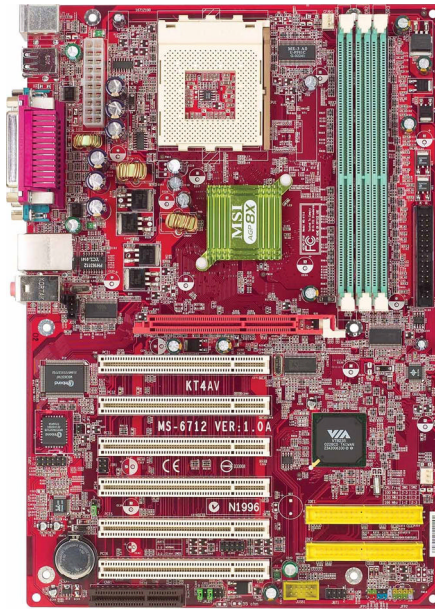

KT4AV

MS-6712 (v1.X) ATX Mainboard



G52-M6712XJ



FCC-B Radio Frequency Interference Statement

This equipment has been tested and found to comply with the limits for a class B digital device, pursuant to part 15 of the FCC rules. These limits are designed to provide reasonable protection against harmful interference when the equipment is operated in a commercial environment. This equipment generates, uses and can radiate radio frequency energy and, if not installed and used in accordance with the instruction manual, may cause harmful interference to radio communications. Operation of this equipment in a residential area is likely to cause harmful interference, in which case the user will be required to correct the interference at his own expense.

Notice 1

The changes or modifications not expressly approved by the party responsible for compliance could void the user's authority to operate the equipment.

Notice 2

Shielded interface cables and A.C. power cord, if any, must be used in order to comply with the emission limits.

VOIRLANOTICED'INSTALLATIONAVANTIDERACCORDERAURESEAU.

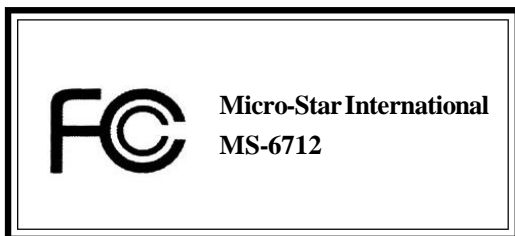

This device complies with Part 15 of the FCC Rules. Operation is subject to the following two conditions:

- (1) this device may not cause harmful interference, and
- (2) this device must accept any interference received, including interference that may cause undesired operation

Copyright Notice

The material in this document is the intellectual property of **MICRO-STAR INTERNATIONAL**. We take every care in the preparation of this document, but no guarantee is given as to the correctness of its contents. Our products are under continual improvement and we reserve the right to make changes without notice.

Trademarks

All trademarks are the properties of their respective owners.

AMD, Athlon™, Athlon™ XP, Thoroughbred™, and Duron™ are registered trademarks of AMD Corporation.

Intel® and Pentium® are registered trademarks of Intel Corporation.

PS/2 and OS®/2 are registered trademarks of International Business Machines Corporation.

Microsoft is a registered trademark of Microsoft Corporation. Windows® 98/2000/NT/XP are registered trademarks of Microsoft Corporation.

NVIDIA, the NVIDIA logo, DualNet, and nForce are registered trademarks or trademarks of NVIDIA Corporation in the United States and/or other countries.

Netware® is a registered trademark of Novell, Inc.

Award® is a registered trademark of Phoenix Technologies Ltd.

AMI® is a registered trademark of American Megatrends Inc.

Kensington and MicroSaver are registered trademarks of the Kensington Technology Group.

PCMCIA and CardBus are registered trademarks of the Personal Computer Memory Card International Association.

Revision History

Revision	Revision History	Date
V1.5	Update CPU spec. for KT4AV Series	May 2004

Technical Support

If a problem arises with your system and no solution can be obtained from the user's manual, please contact your place of purchase or local distributor. Alternatively, please try the following help resources for further guidance.

- 🔍 Visit the MSI website for FAQ, technical guide, BIOS updates, driver updates, and other information: <http://www.msi.com.tw/>
- 🔍 Contact our technical staff at: support@msi.com.tw

Safety Instructions

1. Always read the safety instructions carefully.
2. Keep this User's Manual for future reference.
3. Keep this equipment away from humidity.
4. Lay this equipment on a reliable flat surface before setting it up.
5. The openings on the enclosure are for air convection hence protects the equipment from overheating. **DO NOT COVER THE OPENINGS.**
6. Make sure the voltage of the power source and adjust properly 110/220V before connecting the equipment to the power inlet.
7. Place the power cord such a way that people can not step on it. Do not place anything over the power cord.
8. Always Unplug the Power Cord before inserting any add-on card or module.
9. All cautions and warnings on the equipment should be noted.
10. Never pour any liquid into the opening that could damage or cause electrical shock.
11. If any of the following situations arises, get the equipment checked by a service personnel:
 - The power cord or plug is damaged.
 - Liquid has penetrated into the equipment.
 - The equipment has been exposed to moisture.
 - The equipment has not work well or you can not get it work according to User's Manual.
 - The equipment has dropped and damaged.
 - The equipment has obvious sign of breakage.
12. **DO NOT LEAVE THIS EQUIPMENT IN AN ENVIRONMENT UNCONDITIONED, STORAGE TEMPERATURE ABOVE 60^oC (140^oF), IT MAY DAMAGE THE EQUIPMENT.**



CAUTION: Danger of explosion if battery is incorrectly replaced. Replace only with the same or equivalent type recommended by the manufacturer.

CONTENTS

FCC-B Radio Frequency Interference Statement	ii
Copyright Notice	iii
Revision History	iii
Technical Support	iv
Safety Instructions	iv
Chapter 1. Getting Started	1-1
Mainboard Specifications	1-2
Mainboard Layout	1-4
MSI Special Features	1-5
Live Monitor™	1-5
D-Bracket™ 2 (Optional)	1-6
MSI DVD 5.1 Channel (Optional)	1-8
Live BIOS™/Live Driver™	1-10
CPU Thermal Protection	1-11
S-Bracket (Optional)	1-11
Chapter 2. Hardware Setup	2-1
Quick Components Guide	2-2
Central Processing Unit: CPU	2-3
CPU Core Speed Derivation Procedure	2-3
Thermal Issue for CPU	2-3
CPU Installation Procedures for Socket 462	2-4
Installing AMD Athlon CPU (Socket 462) Cooler Set	2-5
CPU Clock Frequency Selection through BIOS	2-6
Memory	2-7
Introduction to DDR SDRAM	2-7
DIMM Module Combination	2-8
Installing DDR Modules	2-8
Power Supply	2-9

ATX 20-Pin Power Connector: JWR1	2-9
Back Panel	2-10
Mouse Connector	2-10
Keyboard Connector	2-11
USB Connectors	2-11
Parallel Port Connector: LPT1	2-12
Audio Port Connectors	2-13
Serial Port Connectors: COM A & COM B	2-14
RJ-45 LAN Jack (Optional)	2-14
Connectors	2-15
Floppy Disk Drive Connector: FDD1	2-15
Hard Disk Connectors: IDE1 & IDE2	2-16
Fan Power Connectors: CFAN1/SFAN1	2-17
Front Panel Connectors: JFP1 & JFP2	2-18
Front Panel Audio Connector: JAUD1	2-19
Front USB Connector: JUSB1	2-20
D-Bracket™ 2 Connector: JLED1	2-21
S-Bracket Connector: JSP3	2-22
IrDA Infrared Module Header: JIR1	2-24
Chassis Intrusion Switch Connector: JCI1	2-24
CD-In Connector: JCD1	2-25
Jumpers	2-26
Clear CMOS Jumper: JBAT1	2-26
Slots	2-27
AGP (Accelerated Graphics Port) Slot	2-27
PCI (Peripheral Component Interconnect) Slots	2-27
CNR (Communication Network Riser) Slot	2-27
PCI Interrupt Request Routing	2-28
Chapter 3. BIOS Setup	3-1
Entering Setup	3-2

Selecting the First Boot Device	3-2
Control Keys	3-3
Getting Help	3-3
The Main Menu	3-4
Standard CMOS Features	3-6
Advanced BIOS Features	3-8
Advanced Chipset Features	3-13
Power Management Features	3-18
PNP/PCI Configurations	3-22
Integrated Peripherals	3-24
PC Health Status	3-27
Frequency/Voltage Control	3-28
Set Supervisor/User Password	3-30
Load High Performance/BIOS Setup Defaults	3-31
Appendix: Using 4- or 6-Channel Audio Function	A-1
Installing the Audio Driver	A-2
Using 4- or 6-Channel Audio Function	A-4
Testing the Connected Speakers	A-14
Playing KaraOK	A-16
Troubleshooting	T-1
Glossary	G-1

A thick, horizontal blue brushstroke graphic that spans across the width of the page, positioned below the number '1' and above the title.

Getting Started

Thank you for purchasing the MS-6712 v1.X ATX mainboard. The MS-6712 v1.X ATX mainboard is based on VIA® Apollo KT400A North Bridge & VT8235 South Bridge chipset for optimal system efficiency. Designed to fit the advanced AMD® Athlon™, Athlon™ XP or Duron™ processors, the MS-6712 delivers a high performance and professional desktop platform solution.

Mainboard Specifications

CPU

- ▶ Supports Socket A (Socket-462) for AMD® Athlon™/Athlon™ XP/Duron™ processors
 - ▶ Supports from 1100MHz up to 2800+ or higher speed
- (For the latest information about CPU, please visit our Web site at http://www.msi.com.tw/program/products/mainboard/mbd/pro_mbd_cpu_support.php)

Chipset

- ▶ VIA® KT400A North Bridge
 - Supports 200/266/333MHz front side bus
 - Supports DDR200/266/333/400*
 - Supports AGP 4X and AGP 8X
- ▶ VIA® VT8235 South Bridge
 - Integrated Direct Sound AC97 audio
 - Dual channel Ultra DMA 33/66/100/133 master mode EIDE controller
 - ACPI & PC2001 compliant enhanced power management
 - Integrated USB 2.0 controller

MainMemory

- ▶ Supports six memory banks using three 184-pin DDR DIMMs
 - ▶ Supports up to 3GB PC1600/2100/2700/3200* DDR SDRAMs
 - ▶ Supports 2.5v DDR SDRAM
- * Please refer to *Glossary: Recommended DDR400 Modules* for details.

Slots

- ▶ One AGP (Accelerated Graphics Port) 1.5V 8x/4x slot
- ▶ Six 32-bit PCI bus slots (support 3.3v/5v PCI bus interface)
- ▶ One CNR (Communication Network Riser) slot

On-BoardIDE

- ▶ An IDE controller on the VT8235 chipset provides IDE HDD/CD-ROM with PIO, Bus Master and Ultra DMA133/100/66/33 operation modes
- ▶ Can connect up to four IDE devices

On-Board Peripherals

- ▶ On-Board Peripherals include:
 - 1 floppy port supports 2 FDDs with 360K, 720K, 1.2M, 1.44M and

- 2.88Mbytes
- 2 serial ports (COM A + COM B)
- 1 parallel port supports SPP/EPP/ECP mode
- Vertical audio ports
- 1 SPDIF output (2 x 6 pin) with housing (Optional)
- 6 USB ports (Rear * 4/ Front * 2)

Audio

- ▶ RealTek ALC650 6-channel audio

LAN

- ▶ VIA VT6103 LAN controller

BIOS

- ▶ The mainboard BIOS provides “Plug & Play” BIOS which detects the peripheral devices and expansion cards of the board automatically.
- ▶ The mainboard provides a Desktop Management Interface (DMI) function which records your mainboard specifications.

Dimension

- ▶ ATX Form Factor: 30.5 cm (L) x 21 cm (W)

Mounting

- ▶ 6 mounting holes

Others

- ▶ Suspend to RAM/Disk (S3/S4)
- ▶ PC2001 compliant
- ▶ Support WOL/WOR

Mainboard Layout

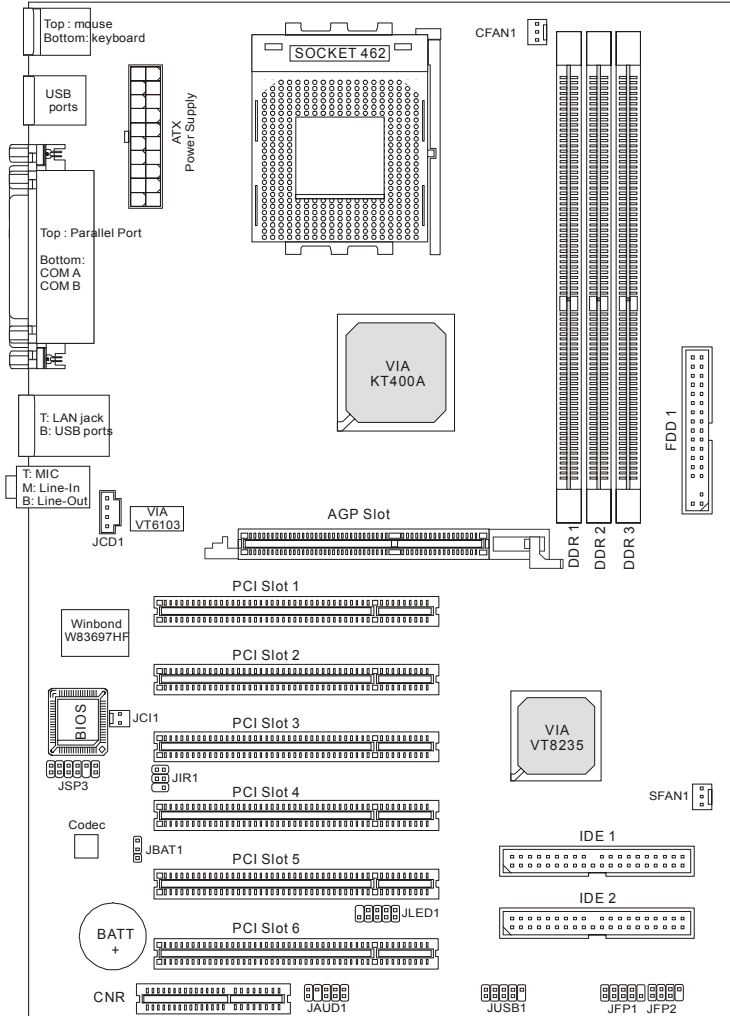

MS-6712 v1.X ATX Mainboard

MSI Special Features

Live Monitor™

The Live Monitor™ is a tool used to schedule the search for the latest BIOS/drivers version on the MSI Web site. To use the function, you need to install the “MSI Live Update 2” application. After the installation, the “MSI Live Monitor” icon (as shown on the right) will appear on the screen. Double click this icon to run the application.



Double click the “MSI Live Monitor” icon  at the lower-right corner of the taskbar, and the following dialog box will appear. You can specify how often the system will automatically search for the BIOS/drivers version, or change the LAN settings right from the dialog box.

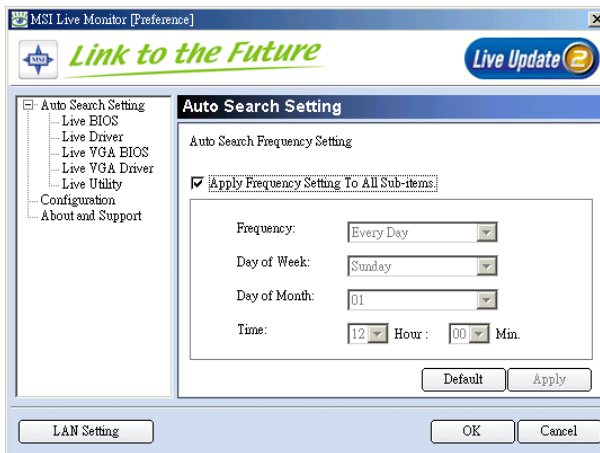

You can right-click the MSI Live Monitor icon  to perform the functions listed below:

- **Auto Search** – Searches for the BIOS/drivers version you need immediately.
- **View Last Result** – Allows you to view the last search result if there is any.
- **Preference** – Configures the Search function, including the Search schedule.
- **Exit** – Exits the Live Monitor™ application.
- **FAQ** – Provides a link to a database which contains various possible questions about MSI's products for users to inquire.

D-Bracket™ 2 (Optional)







D-Bracket™ 2 is a USB bracket integrating four Diagnostic LEDs, which use graphic signal display to help users understand their system. The LEDs provide up to 16 combinations of signals to debug the system. The 4 LEDs can detect all problems that fail the system, such as VGA, RAM or other failures. This special feature is very useful for overclocking users. These users can use the feature to detect if there are any problems or failures. D-Bracket™ 2 supports both USB 1.1 & 2.0 spec.

D-Bracket™ 2 for mainboard with bluetooth connector (1 port)













D-Bracket™ 2 for mainboard without bluetooth connector (2 ports)



D-Bracket™ 2	Description
	System Power ON - The D-LED will hang here if the processor is damaged or not installed properly.
	Early Chipset Initialization
	Memory Detection Test - Testing onboard memory size. The D-LED will hang if the memory module is damaged or not installed properly.
	Decompressing BIOS image to RAM for fast booting.
	Initializing Keyboard Controller.
	Testing VGA BIOS - This will start writing VGA sign-on message to the screen.

● Red ○ Green

D-Bracket™ 2	Description
	<p>Processor Initialization</p> <p>- This will show information regarding the processor (like brand name, system bus, etc...)</p>
	<p>Testing RTC (Real Time Clock)</p>
	<p>Initializing Video Interface</p> <p>- This will start detecting CPU clock, checking type of video onboard. Then, detect and initialize the video adapter.</p>
	<p>BIOS Sign On</p> <p>- This will start showing information about logo, processor brand name, etc....</p>
	<p>Testing Base and Extended Memory</p> <p>- Testing base memory from 240K to 640K and extended memory above 1MB using various patterns.</p>
	<p>Assign Resources to all ISA.</p>
	<p>Initializing Hard Drive Controller</p> <p>- This will initialize IDE drive and controller.</p>
	<p>Initializing Floppy Drive Controller</p> <p>- This will initializing Floppy Drive and controller.</p>
	<p>Boot Attempt</p> <p>- This will set low stack and boot via INT 19h.</p>
	<p>Operating System Booting</p>

MSI DVD 5.1 Channel (Optional)

The motherboard comes with MSI DVD application which supports 5.1 channel (6-channel audio) operation. The accompanying MSI DVD is a convenient tool to meet increasing demands for home entertainment.



To play DVD with 6-channel audio output, you must configure both the MSI DVD application and the audio codec's software utility. Otherwise, the 6-channel audio function will not work properly. For information on how to select 6-channel mode in the audio software utility, refer to *Appendix. Using 4- or 6-Channel Audio Function.*

Follow the procedures below to enable 6-channel support with MSI DVD:

1. Click on this button  from the control panel of MSI DVD.
2. Click the **Audio** tab.
3. Select **6 speaker mode (5.1 channel)**.



MSI Reminds You...

MSI DVD supports Dolby Digital format only. To view DTS-formatted video, you should convert it to Dolby Digital format first.

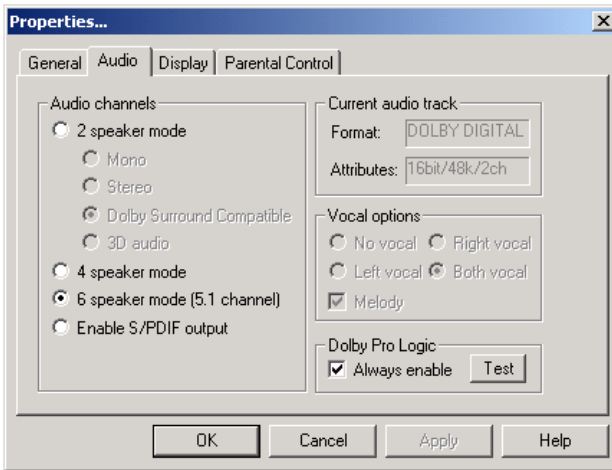

4. Click **OK**.

For more information about MSI DVD, you can refer to the online help coming with the application.

To enter the online help:

1. Click on the icon  at the bottom-right corner of the control panel.
2. The following window appears.

Click here

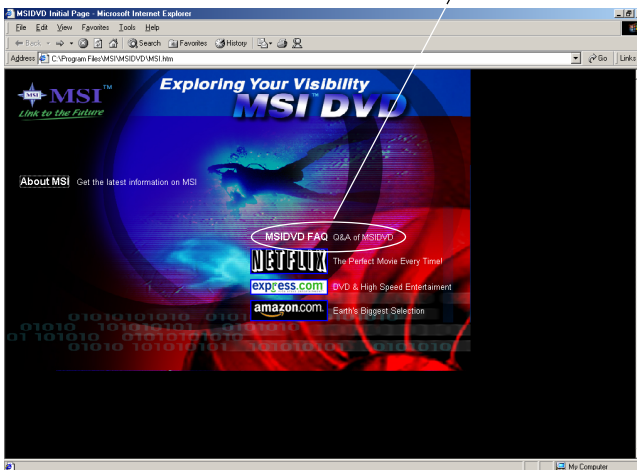

3. Click **MSI DVD FAQ**.

Live BIOS™/Live Driver™

The Live BIOS™/Live Driver™ is a tool used to detect and update your BIOS/drivers online so that you don't need to search for the correct BIOS/driver version throughout the Web site. To use the function, you need to install the “MSI Live Update 2” application. After the installation, the “MSI Live Update 2” icon (as shown on the right) will appear on the screen.



Double click the “MSI Live Update 2” icon, and the following screen will appear:

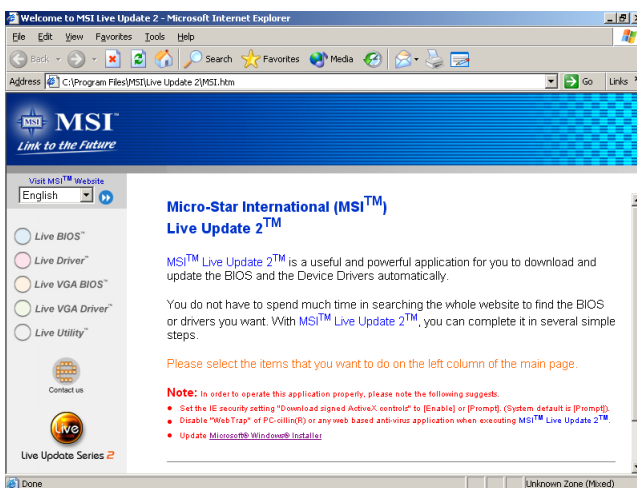

Five buttons are placed on the leftmost pane of the screen. Click the desired button to start the update process.

- **Live BIOS** – Updates the BIOS online.
- **Live Driver** – Updates the drivers online.
- **Live VGA BIOS** – Updates the VGA BIOS online.
- **Live VGA Driver** – Updates the VGA driver online.
- **Live Utility** – Updates the utilities online.

If the product you purchased does not support any of the functions listed above, a “sorry” message is displayed. For more information on the update instructions, insert the companion CD and refer to the “Live Update Guide” under the “Manual” Tab.

CPU Thermal Protection

Aimed to prevent the CPU from overheating, MSI has developed a CPU Thermal Protection mechanism for AMD Athlon™ XP CPU platform. This CPU Thermal Protection mechanism works on a thermal signal sensor. If the mechanism senses an abnormal temperature rise, it will automatically shut down the system and the CPU temperature will then drop down and resume normal. With this unique feature, users can better protect their CPU. Please note that this feature is for AMD Athlon™ XP CPU only.

S-Bracket (Optional)

S-Bracket is a bracket which provides 2 SPDIF jacks for digital audio transmission and 2 analog Line-Out connectors for additional 4-channel analog audio output. With the S-Bracket, your system will be able to perform 6-channel audio operation for wonderful surround sound effect, or connect to Sony & Philips Digital Interface (SPDIF) speakers for audio transmission with better quality.

The S-Bracket offers two types of SPDIF connectors: one for optical fiber and the other for coaxial connection. Select the appropriate one to meet your own need. For more information on S-Bracket, refer to *Appendix. Using 4- or 6-Channel Audio Function*.

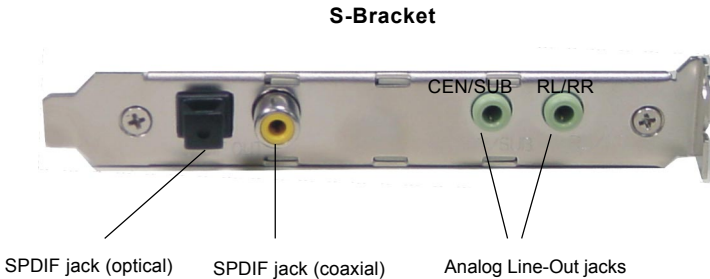

2

Hardware Setup

This chapter tells you how to install the CPU, memory modules, and expansion cards, as well as how to setup the jumpers on the mainboard. Also, it provides the instructions on connecting the peripheral devices, such as the mouse, keyboard, etc.

While doing the installation, be careful in holding the components and follow the installation procedures.

Quick Components Guide

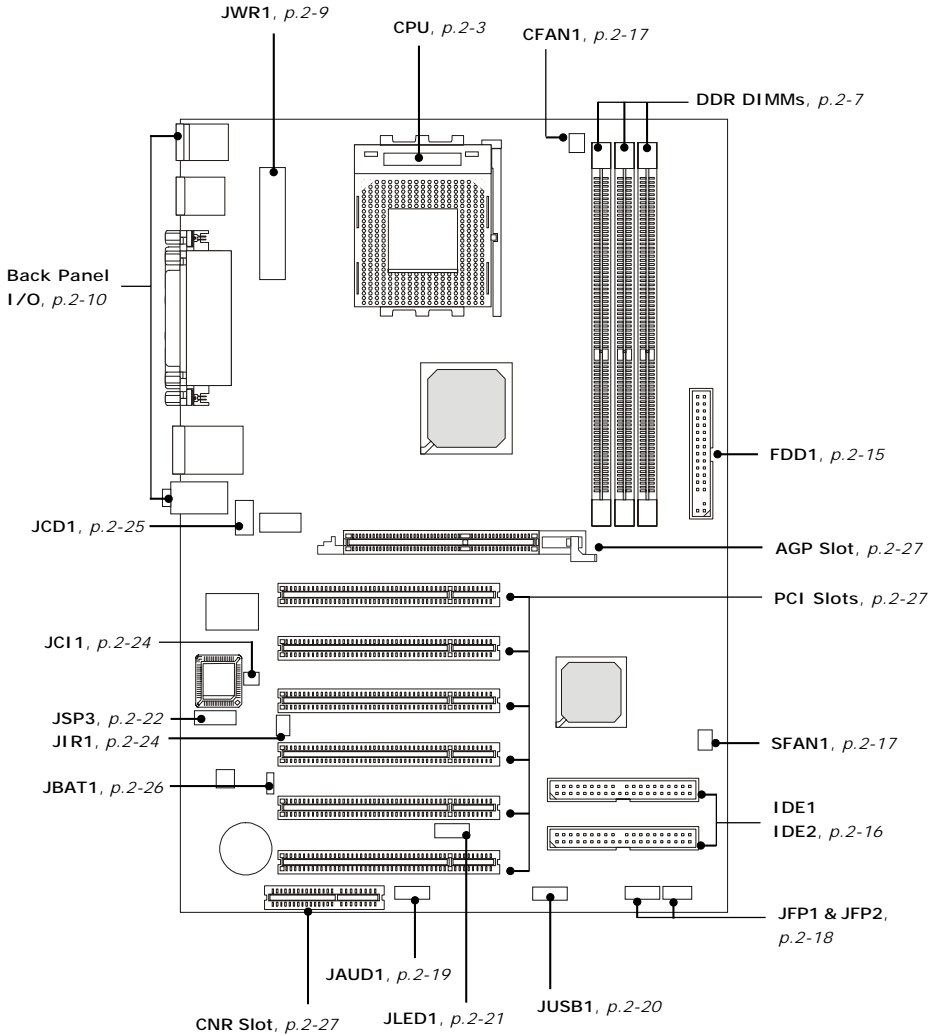

Central Processing Unit: CPU

The mainboard supports AMD® Athlon™, Athlon™ XP and Duron™ processors in the 462 pin package. The mainboard uses a CPU socket called Socket A for easy CPU installation. When you are installing the CPU, **make sure the CPU has a heat sink and a cooling fan attached on the top to prevent overheating.** If you do not find the heat sink and cooling fan, contact your dealer to purchase and install them before turning on the computer.

CPU Core Speed Derivation Procedure

If	<u>CPU Clock</u>	=	100MHz
	<u>Core/Bus ratio</u>	=	14
then	<u>CPU core speed</u>	=	<u>Host Clock</u> x <u>Core/Bus ratio</u>
		=	100MHz x 14
		=	1.4 GHz



WARNING! Thermal Issue for CPU

As processor technology pushes to faster speeds and higher performance, thermal management becomes increasingly crucial when building computer systems. Maintaining the proper thermal environment is key to reliable operation. As such, the processor must be maintained in the specified thermal requirements.

AMD Athlon™/Duron™/Athlon™ XP processor with a speed of **1100MHz and above** requires a LARGER heatsink and fan. You also need to add thermal grease between the CPU and heatsink to improve heat dissipation. Then, make sure that the CPU and heatsink are securely fastened and in good contact with each other. These are needed to prevent damaging the processor and ensuring reliable operation. If you want to get more information on the proper cooling, you can visit AMD's website for reference.

CPU Installation Procedures for Socket 462

1. Please turn off the power and unplug the power cord before installing the CPU.
2. Pull the lever sideways away from the socket. Make sure to raise the lever up to a 90-degree angle.
3. Look for the gold arrow. The gold arrow should point towards the lever pivot. The CPU can only fit in the correct orientation.
4. If the CPU is correctly installed, the pins should be completely embedded into the socket and can not be seen. Please note that any violation of the correct installation procedures may cause permanent damages to your mainboard.
5. Press the CPU down firmly into the socket and close the lever. As the CPU is likely to move while the lever is being closed, always close the lever with your fingers pressing tightly on top of the CPU to make sure the CPU is properly and completely embedded into the socket.

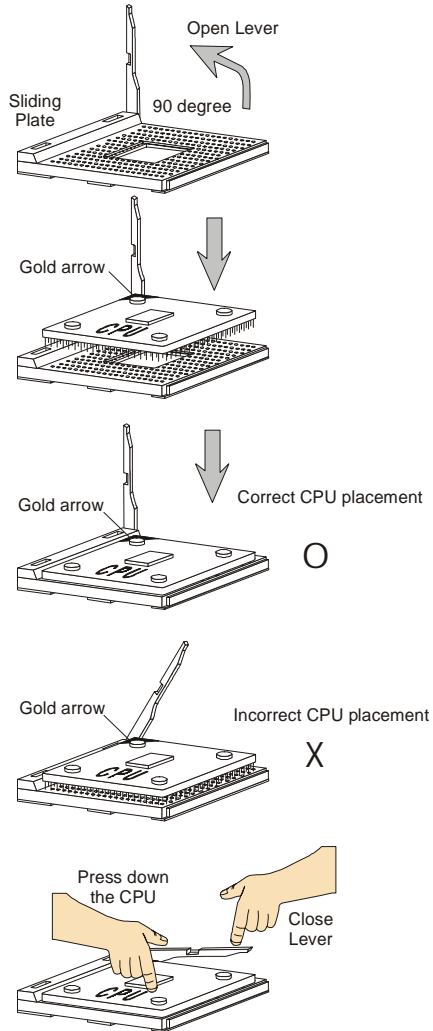

Installing AMD Athlon CPU (Socket 462) Cooler Set

The following instructions will guide you through the heat sink installation procedures. Please consult your agent for the proper CPU cooler set.

1. Position your CPU cooler set onto the CPU.
2. Use one end of the clip to hook the latch of the CPU sliding plate.
3. Hook the other latch to fix the cooling fan set. You may need a screw driver to press down the other side of the clip.
4. Connect the fan to the power supply connector provided on your mainboard.

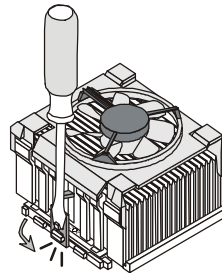
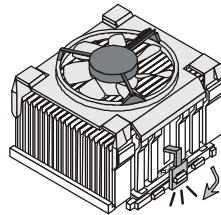
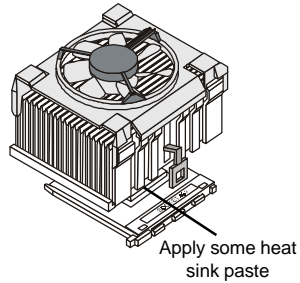

MSI Reminds You...

Please apply some heat sink paste on top of your CPU to dissipate the heat more effectively.

CPU Clock Frequency Selection through BIOS

The hardware configuration for CPU clock frequency of the motherboard is set to 100MHz by default. Therefore, to make a 133MHz CPU run at 133MHz when it is installed on the board, you have to adjust the CPU clock frequency in the BIOS setup utility.

To set the clock frequency for the installed CPU, refer to *Frequency/Voltage Control* in *Chapter 3. BIOS Setup*.



MSI Reminds You...

Overheating

Overheating will seriously damage the CPU and system, always make sure the cooling fan can work properly to protect the CPU from overheating.

Replacing the CPU

While replacing the CPU, always turn off the ATX power supply or unplug the power supply's power cord from grounded outlet first to ensure the safety of CPU.

Overclocking

*This motherboard is designed to support overclocking. However, please make sure your components are able to tolerate such abnormal setting, while doing overclocking. Any attempt to operate beyond product specifications is not recommended. **We do not guarantee the damages or risks caused by inadequate operation or beyond product specifications.***

Memory

The mainboard provides 3 slots for 184-pin DDR SDRAM DIMM (Double In-Line Memory Module) modules and supports the memory size up to 3GB. You can install PC3200/DDR400, PC2700/DDR333, PC2100/DDR266 or PC1600/DDR200 modules on the DDR DIMM slots. Please note that the mainboard supports only one DDR400 DIMM.

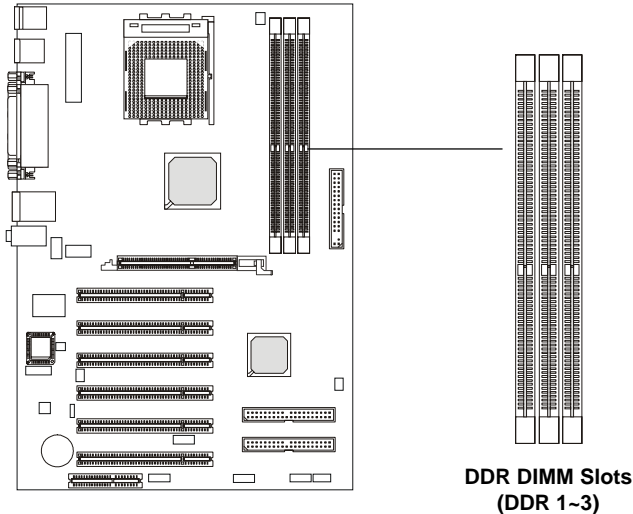

Introduction to DDR SDRAM

DDR (Double Data Rate) SDRAM is similar to conventional SDRAM, but doubles the rate by transferring data twice per cycle. It uses 2.5 volts as opposed to 3.3 volts used in SDR SDRAM, and requires 184-pin DIMM modules rather than 168-pin DIMM modules used by SDR SDRAM. High memory bandwidth makes DDR an ideal solution for high performance PC, workstations and servers.

DIMM Module Combination

Install at least one DIMM module on the slots. You can install either single- or double-sided modules in any order to meet your own needs.

Memory modules can be installed in any combination as follows:

Slot	Memory Module	Total Memory
DIMM 1 (Bank 0 & 1)	S/D	64MB~1GB
DIMM 2 (Bank 2 & 3)	S/D	64MB~1GB
DIMM 3 (Bank 4 & 5)	S/D	64MB~1GB
Maximum System Memory Supported		64MB~3GB

S: Single Side

D: Double Side

Installing DDR Modules

1. The DDR DIMM has only one notch on the center of module. The module will only fit in the right orientation.
2. Insert the DIMM memory module vertically into the DIMM slot. Then push it in until the golden finger on the memory module is deeply inserted in the socket.
3. The plastic clip at each side of the DIMM slot will automatically close.

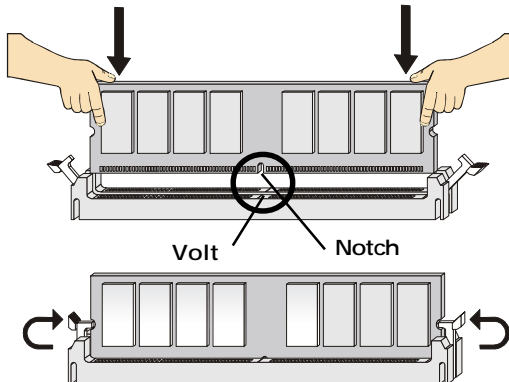

MSI Reminds You...

You can barely see the golden finger if the module is properly inserted in the socket.

Power Supply

The mainboard supports ATX power supply for the power system. Before inserting the power supply connector, always make sure that all components are installed properly to ensure that no damage will be caused.

ATX 20-Pin Power Connector: JWR1

This connector allows you to connect to an ATX power supply. To connect to the ATX power supply, make sure the plug of the power supply is inserted in the proper orientation and the pins are aligned. Then push down the power supply firmly into the connector.

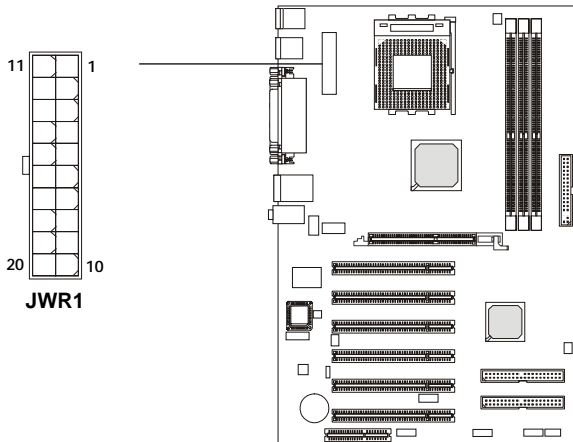

JWR1 Pin Definition

PIN	SIGNAL	PIN	SIGNAL
1	3.3V	11	3.3V
2	3.3V	12	-12V
3	GND	13	GND
4	5V	14	PS_ON
5	GND	15	GND
6	5V	16	GND
7	GND	17	GND
8	PW_OK	18	-5V
9	5V_SB	19	5V
10	12V	20	5V

Back Panel

The back panel provides the following connectors:

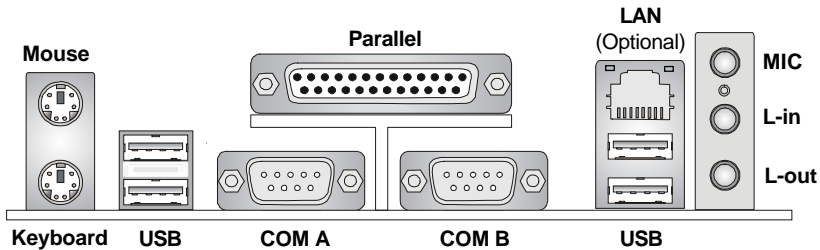

Mouse Connector

The mainboard provides a standard PS/2[®] mouse mini DIN connector for attaching a PS/2[®] mouse. You can plug a PS/2[®] mouse directly into this connector. The connector location and pin assignments are as follows:

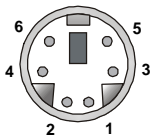

PS/2 Mouse (6-pin Female)

Pin Definition

PIN	SIGNAL	DESCRIPTION
1	Mouse DATA	Mouse DATA
2	NC	No connection
3	GND	Ground
4	VCC	+5V
5	Mouse Clock	Mouse clock
6	NC	No connection

Keyboard Connector

The mainboard provides a standard PS/2[®] keyboard mini DIN connector for attaching a PS/2[®] keyboard. You can plug a PS/2[®] keyboard directly into this connector.

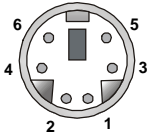

PS/2 Keyboard (6-pin Female)

Pin Definition

PIN	SIGNAL	DESCRIPTION
1	Keyboard DATA	Keyboard DATA
2	NC	No connection
3	GND	Ground
4	VCC	+5V
5	Keyboard Clock	Keyboard clock
6	NC	No connection

USB Connectors

The mainboard provides a UHCI (Universal Host Controller Interface) Universal Serial Bus root for attaching USB devices such as keyboard, mouse or other USB-compatible devices. You can plug the USB device directly into the connector.

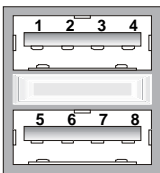

USB Ports

USB Port Description

PIN	SIGNAL	DESCRIPTION
1	VCC	+5V
2	-Data 0	Negative Data Channel 0
3	+Data0	Positive Data Channel 0
4	GND	Ground
5	VCC	+5V
6	-Data 1	Negative Data Channel 1
7	+Data 1	Positive Data Channel 1
8	GND	Ground

Parallel Port Connector: LPT1

The mainboard provides a 25-pin female centronic connector as LPT. A parallel port is a standard printer port that supports Enhanced Parallel Port (EPP) and Extended Capabilities Parallel Port (ECP) mode.

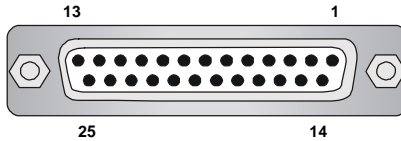

Pin Definition

PIN	SIGNAL	DESCRIPTION
1	STROBE	Strobe
2	DATA0	Data0
3	DATA1	Data1
4	DATA2	Data2
5	DATA3	Data3
6	DATA4	Data4
7	DATA5	Data5
8	DATA6	Data6
9	DATA7	Data7
10	ACK#	Acknowledge
11	BUSY	Busy
12	PE	Paper End
13	SELECT	Select
14	AUTO FEED#	Automatic Feed
15	ERR#	Error
16	INIT#	Initialize Printer
17	SLIN#	Select In
18	GND	Ground
19	GND	Ground
20	GND	Ground
21	GND	Ground
22	GND	Ground
23	GND	Ground
24	GND	Ground
25	GND	Ground

Audio Port Connectors

Line Out is a connector for Speakers or Headphones. **Line In** is used for external CD player, Tape player, or other audio devices. **Mic** is a connector for microphones.

1/8" Stereo Audio Connectors

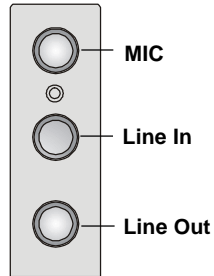

MSI Reminds You...

*For advanced audio application, **RealTek ALC650 audio chip** is provided as an option to offer support for **6-channel audio operation** and can turn rear audio connectors from 2-channel to 4-/6-channel audio. For more information on **6-channel audio operation**, please refer to Appendix. Using 4- or 6-Channel Audio Function.*

Serial Port Connectors: COM A & COM B

The mainboard offers two 9-pin male DIN connectors as serial port COM A & COM B. The ports are 16550A high speed communication ports that send/receive 16 bytes FIFOs. You can attach a serial mouse or other serial devices directly to the connectors.

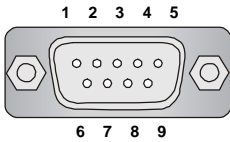

9-Pin Male DIN Connector

Pin Definition

PIN	SIGNAL	DESCRIPTION
1	DCD	Data Carry Detect
2	SIN	Serial In or Receive Data
3	SOUT	Serial Out or Transmit Data
4	DTR	Data Terminal Ready)
5	GND	Ground
6	DSR	Data Set Ready
7	RTS	Request To Send
8	CTS	Clear To Send
9	RI	Ring Indicate

RJ-45 LAN Jack (Optional)

The mainboard provides a RJ-45 connector that allows your computer to be connected to a network environment.

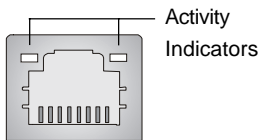

**LAN Jack
(RJ-45)**

Pin	Signal	Description
1	TDP	Transmit differential pair
2	TDN	Transmit differential pair
3	RDP	Receive differential pair
4	NC	Not used
5	NC	Not used
6	RDN	Receive differential pair
7	NC	Not used
8	NC	Not used

Connectors

The mainboard provides connectors to connect to FDD, IDE HDD, case, modem, LAN, USB Ports, IR module and CPU/System FAN.

Floppy Disk Drive Connector: FDD1

The mainboard provides a standard floppy disk drive connector that supports 360K, 720K, 1.2M, 1.44M and 2.88M floppy disk types.

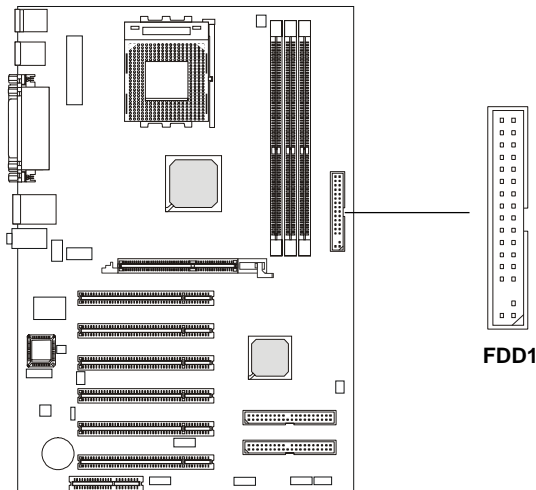

Hard Disk Connectors: IDE1 & IDE2

The mainboard has a 32-bit Enhanced PCI IDE and Ultra DMA 33/66/100/133 controller that provides PIO mode 0~4, Bus Master, and Ultra DMA 33/66/100/133 function. You can connect up to four hard disk drives, CD-ROM, 120MB Floppy (reserved for future BIOS) and other devices.

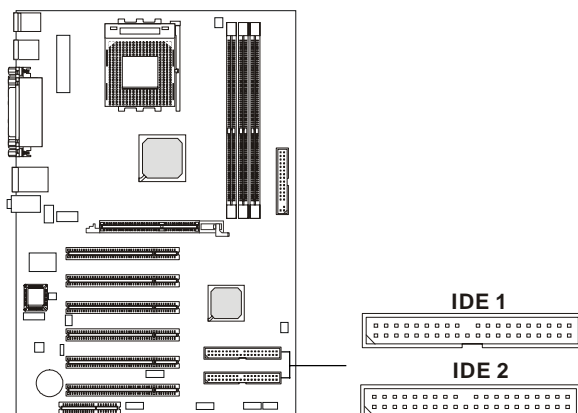

IDE1 (Primary IDE Connector)

The first hard drive should always be connected to IDE1. IDE1 can connect a Master and a Slave drive. You must configure second hard drive to Slave mode by setting the jumper accordingly.

IDE2 (Secondary IDE Connector)

IDE2 can also connect a Master and a Slave drive.



MSI Reminds You...

If you install two hard disks on cable, you must configure the second drive to Slave mode by setting its jumper. Refer to the hard disk documentation supplied by hard disk vendors for jumper setting instructions.

Fan Power Connectors: CFAN1/SFAN1

The CFAN1 (processor fan) and SFAN1 (system fan) support system cooling fan with +12V. It supports three-pin head connector. When connecting the wire to the connectors, always take note that the red wire is the positive and should be connected to the +12V, the black wire is Ground and should be connected to GND. If the mainboard has a System Hardware Monitor chipset on-board, you must use a specially designed fan with speed sensor to take advantage of the CPU fan control.

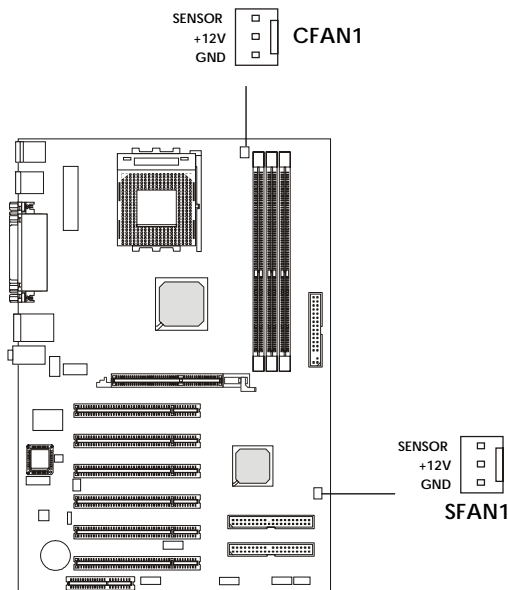

MSI Reminds You...

1. Always consult the vendors for proper CPU cooling fan.
2. CPUFAN supports the fan control. You can install the PC Alert utility that will automatically control the CPU fan speed according to the actual CPU temperature.

Front Panel Connectors: JFP1 & JFP2

The mainboard provides two front panel connectors for electrical connection to the front panel switches and LEDs. JFP1 is compliant with Intel® Front Panel I/O Connectivity Design Guide.

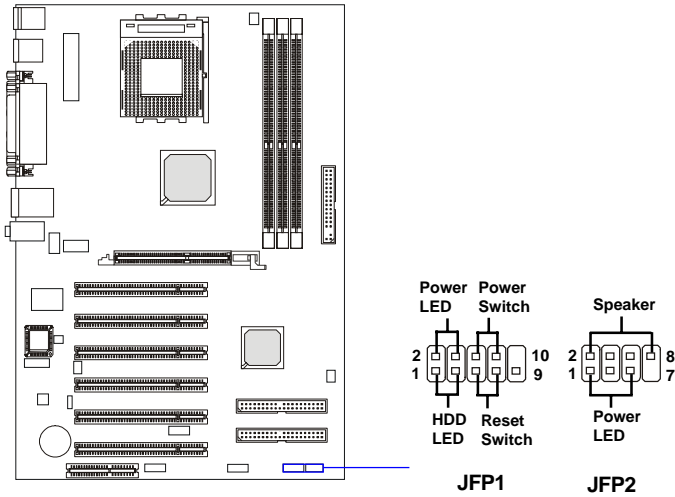

JFP1 Pin Definition

PIN	SIGNAL	DESCRIPTION
1	HD_LED_P	Hard disk LED pull-up
2	FP_PWR/SLP	MSG LED pull-up
3	HD_LED_N	Hard disk active LED
4	FP_PWR/SLP	MSG LED pull-up
5	RST_SW_N	Reset Switch low reference pull-down to GND
6	PWR_SW_P	Power Switch high reference pull-up
7	RST_SW_P	Reset Switch high reference pull-up
8	PWR_SW_N	Power Switch low reference pull-down to GND
9	RSVD_DNU	Reserved. Do not use.

JFP2 Pin Definition

PIN	SIGNAL	PIN	SIGNAL
1	GND	2	SPK-
3	SLED	4	BUZ+
5	PLED	6	BUZ-
7	NC	8	SPK+

Front Panel Audio Connector: JAUD1

The JAUD1 front panel audio connector allows you to connect to the front panel audio and is compliant with Intel® Front Panel I/O Connectivity Design Guide.

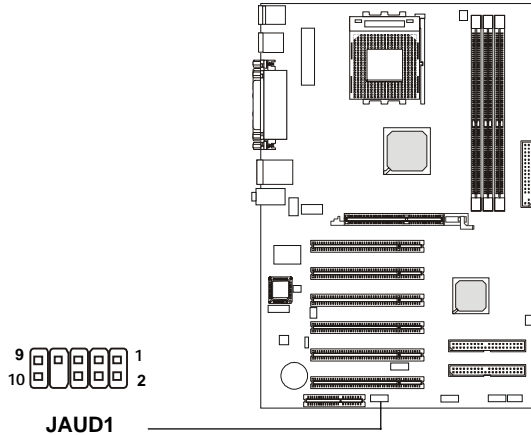

Pin Definition

PIN	SIGNAL	DESCRIPTION
1	AUD_MIC	Front panel microphone input signal
2	AUD_GND	Ground used by analog audio circuits
3	AUD_MIC_BIAS	Microphone power
4	AUD_VCC	Filtered +5V used by analog audio circuits
5	AUD_FPOUT_R	Right channel audio signal to front panel
6	AUD_RET_R	Right channel audio signal return from front panel
7	HP_ON	Reserved for future use to control headphone amplifier
8	KEY	No pin
9	AUD_FPOUT_L	Left channel audio signal to front panel
10	AUD_RET_L	Left channel audio signal return from front panel



MSI Reminds You...

If you don't want to connect to the front audio header, pins 5 & 6, 9 & 10 have to be jumpered in order to have signal output directed to the rear audio ports. Otherwise, the Line-Out connector on the back panel will not function.



Front USB Connector: JUSB1

The mainboard provides one USB 2.0 pinheader. The JUSB1 is compliant with Intel® I/O Connectivity Design Guide.

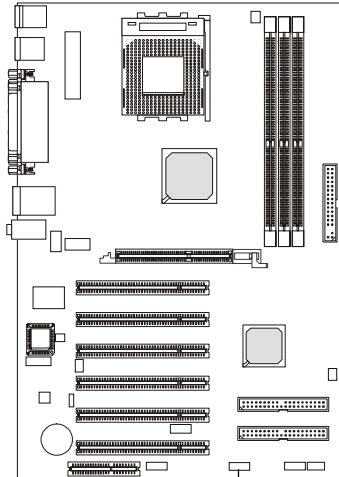

JUSB1 Pin Definition

Pin	Description	Pin	Description
1	VCC	2	VCC
3	USB0-	4	USB1-
5	USB0+	6	USB1+
7	GND	8	GND
9	Key	10	USBOC



JUSB1
(USB 1.1/Intel spec)



MSI Reminds You...

The USB 2.0 technology is downward compatible with USB 1.1 spec. To use the USB 2.0 ports, you have to install the US 2.0 driver, which is supplied by Microsoft for Windows® 2000 and XP. If you have any problems regarding the USB 2.0 driver, please visit the Microsoft Web site for more information.

For details on the bluetooth settings, please refer to PC2PC Bluetooth Manual.

D-Bracket™ 2 Connector: JLED1

The mainboard comes with a JLED1 connector for you to connect to D-Bracket™ 2. D-Bracket™ 2 is a USB Bracket that supports both USB1.1 & 2.0 spec. It integrates four LEDs and allows users to identify system problem through 16 various combinations of LED signals. For definitions of 16 signal combinations, please refer to *D-Bracket™ 2 (Optional)* in Chapter 1.

Pin Definition

Pin	Signal
1	DBG1 (high for green color)
2	DBR1 (high for red color)
3	DBG2 (high for green color)
4	DBR2 (high for red color)
5	DBG3 (high for green color)
6	DBR3 (high for red color)
7	DBG4 (high for green color)
8	DBR4 (high for red color)
9	Key
10	NC

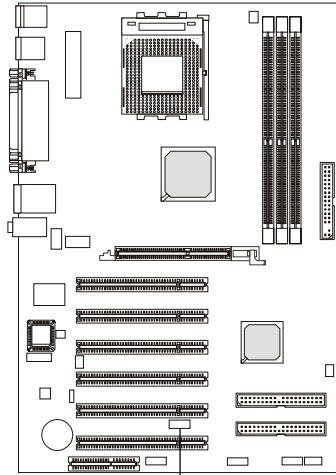

Connected to JLED1
Connected to JUSB1

Connected to JUSB1

D-Bracket™ 2



LEDs

S-Bracket Connector: JSP3

The connector allows you to connect a S-Bracket for Sony & Philips Digital Interface (SPDIF). The S-Bracket offers 2 SPDIF jacks for digital audio transmission (one for optical fiber connection and the other for coaxial), and 2 analog Line-Out jacks for 4-channel audio output.

To attach the fiber-optic cable to optical SPDIF jack, you need to remove the plug from the jack first. The two SPDIF jacks support *SPDIF output* only. For more information on the S-Bracket, refer to *Appendix. Using 4- or 6-Channel Audio Function.*

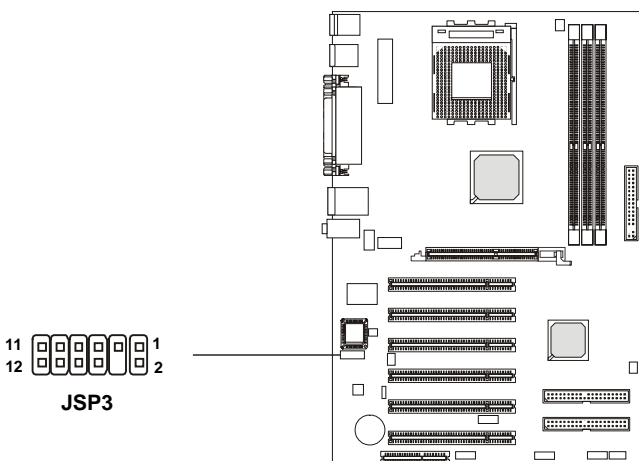

JSP3 Pin Definition

PIN	SIGNAL	DESCRIPTION	PIN	SIGNAL	DESCRIPTION
1	VCC5	VCC 5V	2	VDD3	VDD 3.3V
3	SPDFO	S/PDIF output	4	(No Pin)	Key
5	GND	Ground	6	SPDFI	S/PDIF input
7	LFE-OUT	Audio bass output	8	SOUT-R	Audio right surrounding output
9	CET-OUT	Audio center output	10	SOUT-L	Audio left surrounding output
11	GND	Ground	12	GND	Ground

Optional S-Bracket

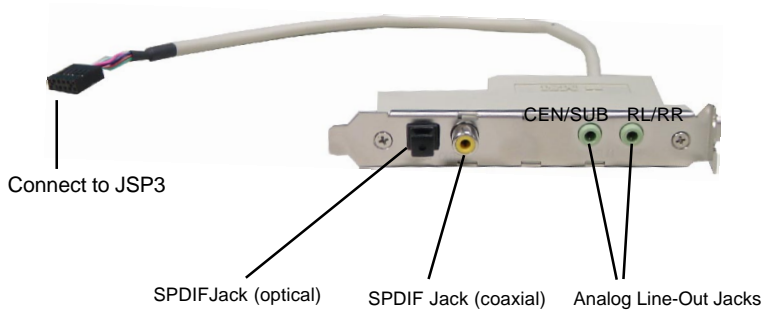

IrDA Infrared Module Header: JIR1

The connector allows you to connect to IrDA Infrared module. You must configure the setting through the BIOS setup to use the IR function. JIR1 is compliant with Intel® Front Panel I/O Connectivity Design Guide.

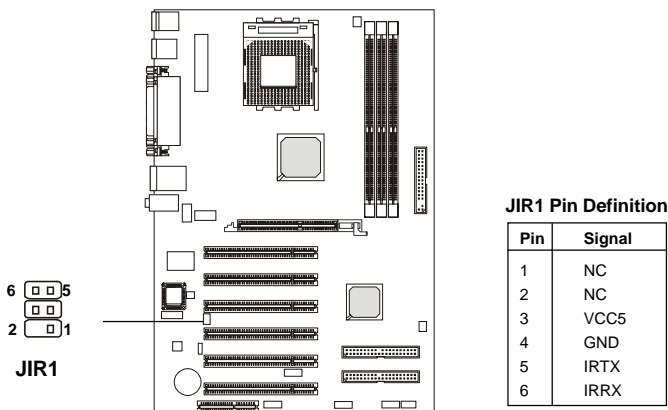

Chassis Intrusion Switch Connector: JCI1

This connector is connected to a 2-pin chassis switch. If the chassis is opened, the switch will be short. The system will record this status and show a warning message on the screen. To clear the warning, you must enter the BIOS utility and clear the record.

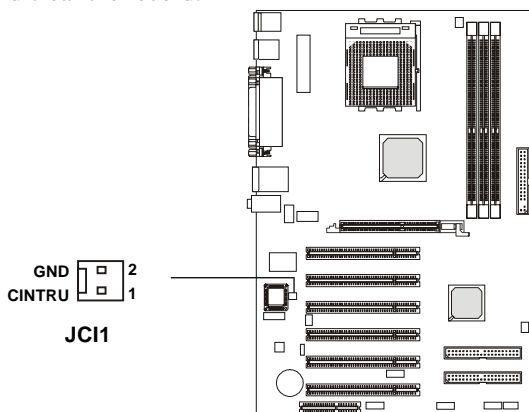

CD-In Connector: JCD1

The connector is for CD-ROM audio connector.

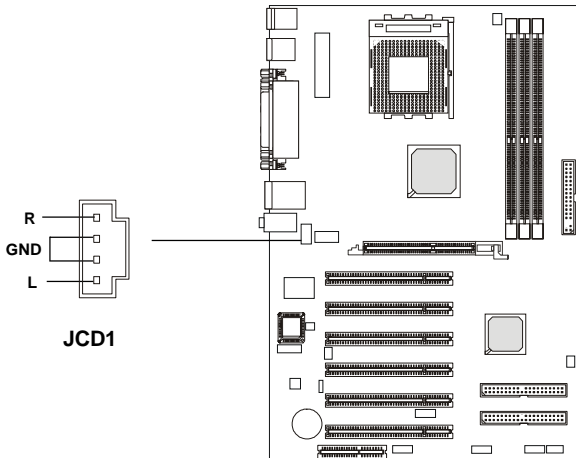

Jumpers

The motherboard provides the following jumpers for you to set the computer's function. This section will explain how to change your motherboard's function through the use of jumpers.

Clear CMOS Jumper: JBAT1

There is a CMOS RAM on board that has a power supply from external battery to keep the data of system configuration. With the CMOS RAM, the system can automatically boot OS every time it is turned on. If you want to clear the system configuration, use the JBAT1 (Clear CMOS Jumper) to clear data. Follow the instructions below to clear the data:

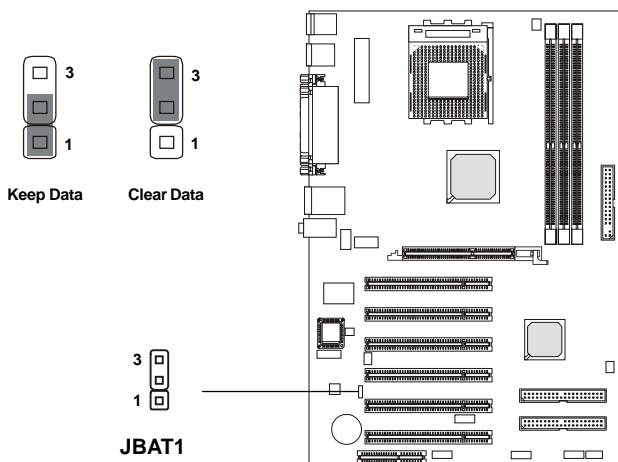

MSI Reminds You...

You can clear CMOS by shorting 2-3 pin while the system is off. Then return to 1-2 pin position. Avoid clearing the CMOS while the system is on; it will damage the mainboard.

Slots

The motherboard provides one AGP slot, six 32-bit PCI bus slots, and one CNR slot.

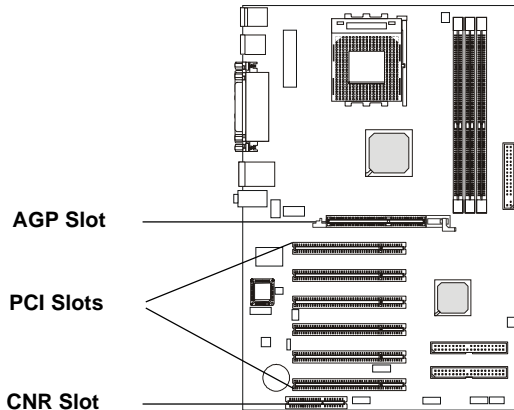

AGP (Accelerated Graphics Port) Slot

The AGP slot allows you to insert the AGP graphics card. AGP is an interface specification designed for the throughput demands of 3D graphics. It introduces a 66MHz, 32-bit channel for the graphics controller to directly access main memory. The mainboard supports 4x/8x 1.5V AGP card.

PCI (Peripheral Component Interconnect) Slots

The PCI slots allow you to insert the expansion cards to meet your needs. When adding or removing expansion cards, make sure that you unplug the power supply first. Meanwhile, read the documentation for the expansion card to make any necessary hardware or software settings for the expansion card, such as jumpers, switches or BIOS configuration.

CNR (Communication Network Riser) Slot

The CNR slot allows you to insert the CNR expansion cards. CNR is a specially designed network, audio, or modem riser card for ATX family motherboards. Its main processing is done through software and controlled by the motherboard's chipset.

PCI Interrupt Request Routing

The IRQ, acronym of interrupt request line and pronounced I-R-Q, are hardware lines over which devices can send interrupt signals to the microprocessor.

The PCI IRQ pins are typically connected to the PCI bus INT A# ~ INT D# pins as follows:

	Order 1	Order 2	Order 3	Order 4
PCI Slot 1	INT A#	INT B#	INT C#	INT D#
PCI Slot 2	INT B#	INT C#	INT D#	INT A#
PCI Slot 3	INT C#	INT D#	INT A#	INT B#
PCI Slot 4	INT D#	INT A#	INT B#	INT C#
PCI Slot 5	INT B#	INT C#	INT D#	INT A#
PCI Slot 6	INT C#	INT D#	INT A#	INT B#

3

BIOS Setup

This chapter provides information on the BIOS Setup program and allows you to configure the system for optimum use. You may need to run the Setup program when:

- ◆ An error message appears on the screen during the system booting up, and requests you to run SETUP.
- ◆ You want to change the default settings for customized features.

Entering Setup

Power on the computer and the system will start POST (Power On Self Test) process. When the message below appears on the screen, press key to enter Setup.

DEL:Setup F11:Boot Menu F12:Network boot TAB:Logo

If the message disappears before you respond and you still wish to enter Setup, restart the system by turning it OFF and On or pressing the RESET button. You may also restart the system by simultaneously pressing <Ctrl>, <Alt>, and <Delete> keys.

Selecting the First Boot Device

You are allowed to select the 1st boot device without entering the BIOS setup utility by pressing <F11>. When the same message as listed above appears on the screen, press <F11> to trigger the boot menu.

The POST messages might pass by too quickly for you to respond in time. If so, restart the system and press <F11> after around 2 or 3 seconds to activate the boot menu similar to the following.

Select First Boot Device	
Floppy	: 1st Floppy
IDE-0	: IBM-DTLA-307038
CDROM	: ATAPI CD-ROM DRIVE 40X M
[Up/Dn] Select	[RETURN] Boot [ESC] cancel

The boot menu will list all the bootable devices. Select the one you want to boot from by using arrow keys and then pressing <Enter>. The system will boot from the selected device. The selection will not make changes to the settings in the BIOS setup utility, so next time when you power on the system, it will still use the original first boot device to boot up.

Control Keys

<↑>	Move to the previous item
<↓>	Move to the next item
<←>	Move to the item on the left-hand side
<→>	Move to the item on the right-hand side
<Enter>	Select the item
<Esc>	Jumps to the Exit menu or returns to the main menu from a submenu
<+ /PU>	Increase the numeric value or make changes
<- /PD>	Decrease the numeric value or make changes
<F1>	General help, only for Status Page Setup Menu and Option Page Setup Menu
<F6>	Load the default CMOS value from Fail-Safe default table, only for Option Page Setup Menu
<F7>	Load Optimized defaults
<F10>	Save all the CMOS changes and exit

Getting Help

After entering the Setup utility, the first screen you see is the Main Menu.

Main Menu

The main menu displays the setup categories the BIOS supplies. You can use the arrow keys (↑↓) to select the item. The on-line description for the selected setup category is displayed at the bottom of the screen.

Default Settings

The BIOS setup program contains two kinds of default settings: the BIOS Setup and High Performance defaults. BIOS Setup defaults provide stable performance settings for all devices and the system, while High Performance defaults provide the best system performance but may affect the system stability.

The Main Menu

Once you enter AMIBIOS NEW SETUP UTILITY, the Main Menu will appear on the screen. The Main Menu displays twelve configurable functions and two exit choices. Use arrow keys to move among the items and press <Enter> to enter the sub-menu.



Standard CMOS Features

Use this menu for basic system configurations, such as time, date etc.

Advanced BIOS Features

Use this menu to setup the items of AMI® special enhanced features.

Advanced Chipset Features

Use this menu to change the values in the chipset registers and optimize your system's performance.

Power Management Features

Use this menu to specify your settings for power management.

PNP/PCI Configurations

This entry appears if your system supports PnP/PCI.

Integrated Peripherals

Use this menu to specify your settings for integrated peripherals.

PC Health Status

This entry shows your PC health status.

Frequency/Voltage Control

Use this menu to specify your settings for frequency/voltage control.

Set Supervisor Password

Use this menu to set Supervisor Password.

Set User Password

Use this menu to set User Password.

Load High Performance Defaults

Use this menu to load the BIOS values for the best system performance, but the system stability may be affected.

Load BIOS Setup Defaults

Use this menu to load factory default settings into the BIOS for stable system performance operations.

Save & Exit Setup

Save changes to CMOS and exit setup.

Exit Without Saving

Abandon all changes and exit setup.

Standard CMOS Features

The items inside STANDARD CMOS FEATURES menu are divided into 9 categories. Each category includes none, one or more setup items. Use the arrow keys to highlight the item you want to modify and use the <PgUp> or <PgDn> keys to switch to the value you prefer.

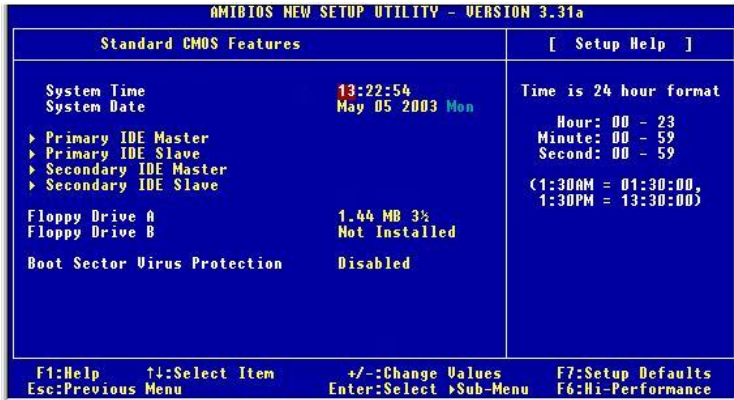

System Time

This allows you to set the system time that you want (usually the current time). The time format is <hour> <minute> <second>.

System Date

This allows you to set the system to the date that you want (usually the current date). The format is <day><month> <date> <year>.

- day** Day of the week, from Sun to Sat, determined by BIOS. Read-only.
- month** The month from Jan. through Dec.
- date** The date from 1 to 31 can be keyed by numeric function keys.
- year** The year can be adjusted by users.

Primary/Secondary IDE Master/Slave

Press PgUp/<+> or PgDn/<-> to select the hard disk drive type. The specifi-

cation of hard disk drive will show up on the right hand according to your selection.

Type	Select how to define the HDD parameters
Cylinders	Enter cylinder number
Heads	Enter head number
Write Precompensation	Enter write precomp cylinder
Sectors	Enter sector number
Maximum Capacity	Read the maximal HDD capacity
LBA Mode	Select <i>Auto</i> for a hard disk > 512 MB under Windows and DOS, or <i>Disabled</i> under Netware and UNIX
Block Mode	Select <i>Auto</i> to enhance the hard disk performance
Fast Programmed I/O Modes	Select <i>Auto</i> to enhance hard disk performance by optimizing the hard disk timing
32 Bit Transfer Mode	Enable 32 bit to maximize the IDE hard disk data transfer rate

Floppy Drive A:/B:

This item allows you to set the type of floppy drives installed. Available options: *Not Installed*, *1.2 MB 5¼*, *720 KB 3½*, *1.44 MB 3½* and *2.88 MB 3½*.

Boot Sector Virus Protection

The item is to set the Virus Warning feature for IDE Hard Disk boot sector protection. When *Enabled*, BIOS will issue a virus warning message and beep if a write to the boot sector or the partition table of the HDD is attempted. Setting options: *Disabled* and *Enabled*.



MSI Reminds You...

This feature only protects the boot sector, not the whole hard disk.

Advanced BIOS Features

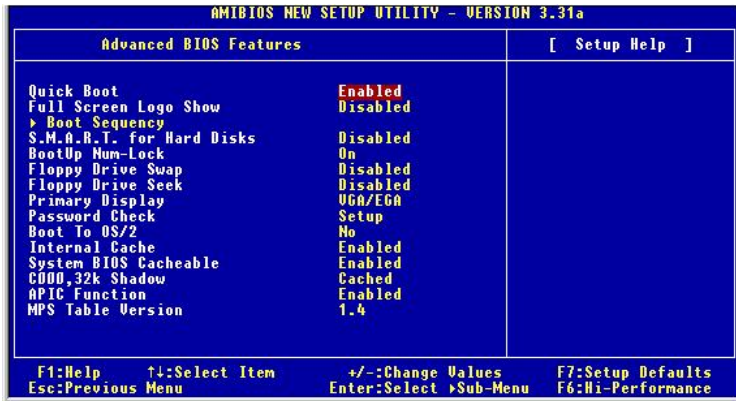

Quick Boot

Setting the item to *Enabled* allows the system to boot within 5 seconds since it will skip some check items. Available options: *Enabled*, *Disabled*.

Full Screen Logo Show

This item enables you to show the company logo on the bootup screen. Settings are:

Enabled Shows a still image (logo) on the full screen at boot.

Disabled Shows the POST messages at boot.

Boot Sequency

Press <Enter> to enter the sub-menu screen.



1st/2nd/3rd Boot Device

The items allow you to set the sequence of boot devices where AMIBIOS attempts to load the operating system. The settings are:

IDE-0 The system will boot from the first HDD.

IDE-1 The system will boot from the second HDD.

<i>IDE-2</i>	The system will boot from the third HDD.
<i>IDE-3</i>	The system will boot from the fourth HDD.
<i>Floppy</i>	The system will boot from floppy drive.
<i>ARMD-FDD</i>	The system will boot from any ARMD device, such as LS-120 or ZIP drive, that functions as a floppy drive.
<i>ARMD-HDD</i>	The system will boot from ARMD device, such as MO or ZIP drive, that functions as hard disk drive.
<i>CD/DVD</i>	The system will boot from the CD/DVD ROM.
<i>Legacy SCSI</i>	The system will boot from the SCSI.
<i>Legacy NET-</i>	The system will boot from the Network drive.
<i>WORK</i>	
<i>BBS-0</i>	The system will boot from the first BBS (BIOS Boot Specification) compliant device.
<i>BBS-1</i>	The system will boot from the second BBS (BIOS Boot Specification) compliant device.
<i>BBS-2</i>	The system will boot from the third BBS (BIOS Boot Specification) compliant device.
<i>BBS-3</i>	The system will boot from the 4th BBS (BIOS Boot Specification) compliant device.
<i>BBS-4</i>	The system will boot from the 5th BBS (BIOS Boot Specification) compliant device.
<i>BBS-5</i>	The system will boot from the 6th BBS (BIOS Boot Specification) compliant device.
<i>BBS-6</i>	The system will boot from the 7th BBS (BIOS Boot Specification) compliant device.
<i>BBS-7</i>	The system will boot from the 8th BBS (BIOS Boot Specification) compliant device.
<i>BBS-8</i>	The system will boot from the 9th BBS (BIOS Boot Specification) compliant device.
<i>BBS-9</i>	The system will boot from the 10th BBS (BIOS Boot Specification) compliant device.
<i>USB FDD</i>	The system will boot from USB-interfaced floppy drive.
<i>USB CDROM</i>	The system will boot from the USB-interfaced CD-ROM.
<i>USB HDD</i>	The system will boot from the USB-interfaced HDD.
<i>USB RMD-FDD</i>	The system will boot from any USB-interfaced ARMD device, such as LS-120 or ZIP drive, that functions as a floppy drive.

- USB RMD- HDD** The system will boot from USB-interfaced ARMD device, such as MO or ZIP drive, that functions as hard disk drive.
- Disabled** Disable this sequence.



MSI Reminds You...

1. Available settings for “1st/2nd/3rd Boot Device” vary depending on the bootable devices you have installed. For example, if you did not install a floppy drive, the setting “Floppy” does not show up.
2. If you want to boot from any of the USB-interfaced devices, please set **USB Legacy Support to All Device**.

Try Other Boot Devices

Setting the option to *Yes* allows the system to try to boot from other devices if the system fails to boot from the 1st/2nd/3rd boot device.

S.M.A.R.T. for Hard Disks

This allows you to activate the S.M.A.R.T. (Self-Monitoring Analysis & Reporting Technology) capability for the hard disks. S.M.A.R.T is a utility that monitors your disk status to predict hard disk failure. This gives you an opportunity to move data from a hard disk that is going to fail to a safe place before the hard disk becomes offline. Settings: *Enabled, Disabled*.

BootUp Num-Lock

This item is to set the Num Lock status when the system is powered on. Setting to *On* will turn on the Num Lock key when the system is powered on. Setting to *Off* will allow end users to use the arrow keys on the numeric keypad. Setting options: *On, Off*.

Floppy Drive Swap

Setting to *Enabled* will swap floppy drives A: and B:.

Floppy Drive Seek

This setting causes the BIOS to search for floppy disk drives at boot time. When enabled, the BIOS will activate the floppy disk drives during the boot process: the drive activity light will come on and the head will move back and forth once. First A: will be done and then B: if it exists. Setting options: *Disabled, Enabled*.

Primary Display

This configures the primary subsystem in the computer. Available options: *Mono (monochrome)*, *CGA40x25*, *CGA80x25*, *VGA/EGA*, *Absent*.

Password Check

This specifies the type of AMIBIOS password protection that is implemented. Setting options are described below.

Option	Description
Setup	The password prompt appears only when end users try to run Setup.
Always	A password prompt appears every time when the computer is powered on or when end users try to run Setup.

Boot To OS/2

This allows you to run the OS/2[®] operating system with DRAM larger than 64MB. When you choose *No*, you cannot run the OS/2[®] operating system with DRAM larger than 64MB. But it is possible if you choose *Yes*.

Internal Cache

Cache memory is additional memory that is much faster than conventional DRAM (system memory). When the CPU requests data, the system transfers the requested data from the main DRAM into cache memory, for even faster access by the CPU. The setting controls the internal cache (also known as L1 or level 1 cache). Setting to *Enabled* will speed up the system performance.

System BIOS Cacheable

Selecting *Enabled* allows caching of the system BIOS ROM at F0000h-FFFFFh, resulting in better system performance. However, if any program writes to this memory area, a system error may result. Setting options: *Enabled*, *Disabled*.

C000, 32k Shadow

This item specifies how the contents of the adapter ROM named in the item are handled. Settings are described below:

Option	Description
Disabled	The specified ROM is not copied to RAM.
Enabled	The contents of specified ROM are copied to RAM for faster system performance.
Cached	The contents of specified ROM are not only copied to RAM, the contents of the ROM area can be written to and read from cache memory.

APIC Function

This field is used to enable or disable the APIC (Advanced Programmable Interrupt Controller). Due to compliance to PC2001 design guide, the system is able to run in APIC mode. Enabling APIC mode will expand available IRQs resources for the system. Settings: *Enabled, Disabled*.

MPS Table Version

This field allows you to select which MPS (Multi-Processor Specification) version to be used for the operating system. You need to select the MPS version supported by your operating system. To find out which version to use, consult the vendor of your operating system. Settings: *1.4, 1.1*.

Advanced Chipset Features

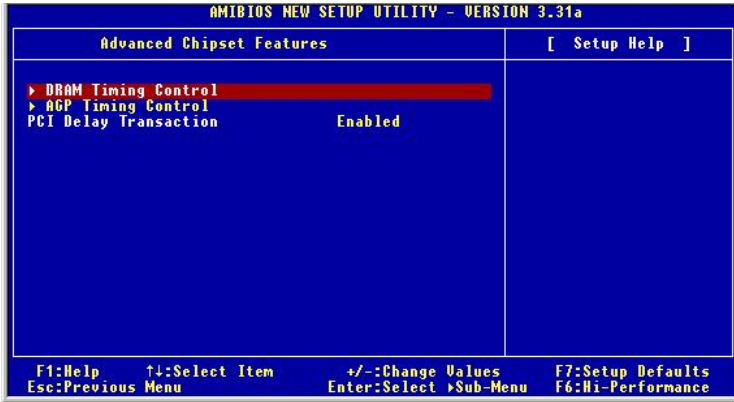

MSI Reminds You...

Change these settings only if you are familiar with the chipset.

DRAM Timing Control

Press <Enter> and the following sub-menu appears.



Current Host Clock

This item shows the current CPU frequency.

Configure SDRAM Timing by

Selects whether DRAM timing is controlled by the SPD (Serial Presence Detect) EEPROM on the DRAM module. Setting to *SPD* enables

SDRAM Frequency, SDRAM CAS# Latency, Row Precharge Time, RAS Pulse Width, RAS to CAS Delay and SDRAM Bank Interleave automatically to be determined by BIOS based on the configurations on the SPD. Selecting *User* allows users to configure these fields manually.

SDRAMFrequency

Use this item to configure the clock frequency of the installed SDRAM. Settings options: *200MHz, 266MHz, 333MHz, 400MHz*, Auto*.
*See *Glossary: Recommended DDR400 Modules* for details.

SDRAM CAS# Latency

This controls the timing delay (in clock cycles) before SDRAM starts a read command after receiving it. Settings: *Auto, 1.5, 2, 2.5, 3* (clocks). 1.5 (clocks) increases the system performance the most while 3 (clocks) provides the most stable performance.

Row Precharge Time

This item controls the number of cycles for Row Address Strobe (RAS) to be allowed to precharge. If insufficient time is allowed for the RAS to accumulate its charge before DRAM refresh, refresh may be incomplete and DRAM may fail to retain data. This item applies only when synchronous DRAM is installed in the system. Available settings: *2T, 3T, 4T, 5T*.

RAS Pulse Width

This setting allows you to select the number of clock cycles allotted for the RAS pulse width, according to DRAM specifications. The less the clock cycles, the faster the DRAM performance. Settings: *6T, 7T, 8T, 9T*.

RAS to CAS Delay

When DRAM is refreshed, both rows and columns are addressed separately. This setup item allows you to determine the timing of the transition from RAS (row address strobe) to CAS (column address strobe). The less the clock cycles, the faster the DRAM performance. Setting options: *2T, 3T, 4T, 5T*.

Bank Interleave

This field selects 2-bank or 4-bank interleave for the installed SDRAM.

Disable the function if 16MB SDRAM is installed. Settings: *Disabled*, *2-Way* and *4-Way*.

DDR400 tWRT Timing

This controls the timing delay (in clock cycles) before DDR400 starts a write command after receiving it. Settings: *1T*, *2T*, *3T*. *3T* increases the delay time while *1T* provides the least timing delay. This option is effective only if DDR400 is running.

SDRAM Burst Length

This setting allows you to set the size of Burst-Length for DRAM. Bursting feature is a technique that DRAM itself predicts the address of the next memory location to be accessed after the first address is accessed. To use the feature, you need to define the burst length, which is the actual length of burst plus the starting address and allows internal address counter to properly generate the next memory location. The bigger the size, the faster the DRAM performance. Settings: *4 QW*, *8 QW*.

SDRAM 1T Command

This setting controls the SDRAM command rate. Selecting *Enabled* allows SDRAM signal controller to run at 1T (T=clock cycles) rate. Selecting *Disabled* makes SDRAM signal controller run at 2T rate. *1T* is faster than *2T*. Setting options: *Disabled*, *Enabled*.

Fast Command

This item controls the internal timing of CPU. Selecting *Ultra* allows CPU to handle data/instructions at the fastest speed. *Fast* enables CPU to handle at a faster speed, while *Normal* let CPU handle them at the slowest rate.

Fast R-2-R Turnaround

Burst read operation can be interrupted by new read of any bank. Random column access is allowed. READ to READ interval is minimum 1 CLK. Selecting *Enabled* to shorten the turnaround interval to improve the performance. Setting options: *Disabled*, *Enabled*.

AGP Timing Control

Press <Enter> and the following sub-menu appears.

AGP Timing Control	
AGP Mode	4x
AGP Fast Write	Enabled
AGP Aperture Size	128MB
AGP Master 1 W/S Write	Disabled
AGP Master 1 W/S Read	Disabled
AGP Read Synchronization	Disabled

AGP Mode

The item sets an appropriate mode for the installed AGP card. Setting options: *1x, 2x, 4x, Auto*. Select *4x* only if your AGP card supports it.

AGP Fast Write

This option enables or disables the AGP Fast Write feature. The Fast Write technology allows the CPU to write directly to the graphics card without passing anything through the system memory and improves the AGP 4X speed. Select *Enabled* only when the installed AGP card supports this function. Settings: *Enabled, Disabled*.

AGP Aperture Size

This setting controls just how much system RAM can be allocated to AGP for video purposes. The aperture is a portion of the PCI memory address range dedicated to graphics memory address space. Host cycles that hit the aperture range are forwarded to the AGP without any translation. The option allows the selection of an aperture size of *4MB, 8MB, 16MB, 32MB, 64MB, 128MB, and 256 MB*.

AGP Master 1 W/S Write

The field allows users to insert one wait state into the AGP write cycle. Settings: *Enabled, Disabled*.

AGP Master 1 W/S Read

The field allows users to insert one wait state into the AGP read cycle. Settings: *Enabled, Disabled*.

AGP Read Synchronization

The field allows you to enable or disable the AGP Read Synchronization feature. Settings: *Enabled, Disabled*.

PCI Delay Transaction

The chipset has an embedded 32-bit posted write buffer to support delayed transactions cycles so that transactions to and from the ISA bus are buffered and PCI bus can perform other transactions while the ISA transaction is underway. Select *Enabled* to support compliance with PCI specification version 2.1. Setting options: *Enabled, Disabled*.

Power Management Features

Power Management Features		[Setup Help]
ACPI Standby State	S1/POS	
Call VGA BIOS at S3 Resuming	Disabled	
USB Wakeup From S3	Enabled	
Power Management/APM	Enabled	
Power/Sleep LED	Single LED	
Suspend Time Out (Minute)	Disabled	
Display Activity	Ignore	
CPU Critical Temperature	Disabled	
CPU HALT Command Detection	Disabled	
Power Button Function	On/Off	
After AC Power Loss	Power Off	
► Set WakeUp Events		

F1:Help ↑↓:Select Item +/-:Change Values F7:Setup Defaults
 Esc:Previous Menu Enter:Select ►Sub-Menu F6:Hi-Performance



MSI Reminds You...

S3-related functions described in this section are available only when your BIOS supports S3 sleep mode.

ACPI Standby State

This item specifies the power saving modes for ACPI function. If your operating system supports ACPI, such as Windows 98SE, Windows ME and Windows 2000, you can choose to enter the Standby mode in S1(POS) or S3(STR) fashion through the setting of this field. Options are:

- S1/POS** The S1 sleep mode is a low power state. In this state, no system context is lost (CPU or chipset) and hardware maintains all system context.
- S3/STR** The S3 sleep mode is a lower power state where the information of system configuration and open applications/files is saved to main memory that remains powered while most other hardware components turn off to save energy. The information stored in memory will be used to restore the system when a “wake up” event occurs.
- Auto** BIOS determines the best mode automatically.

Call VGA BIOS at S3 Resuming

Selecting *Enabled* allows BIOS to call VGA BIOS to initialize the VGA card

when system wakes up (resumes) from S3 sleep state. The system resume time is shortened when you disable the function, but system will need an AGP driver to initialize the VGA card. Therefore, if the AGP driver of the card does not support the initialization feature, the display may work abnormally or not function after resuming from S3.

USB Wakeup From S3

This item allows the activity of the USB device to wake up the system from S3 (Suspend to RAM) sleep state. Settings: *Enabled, Disabled*.

Power Management/APM

Setting to *Enabled* will activate an Advanced Power Management (APM) device to enhance Max Saving mode and stop CPU internal clock. Settings: *Disabled, Enabled*.

Power/Sleep LED

This item configures how the system uses power LED on the case to indicate the sleep/suspend state. Available options are:

Single LED The power LED turns off to indicate the sleep/suspend state.

Dual LED The power LED changes its color to indicate the sleep/suspend state.

Suspend Time Out (Minute)

After the selected period of system inactivity, all devices except the CPU shut off. Settings: *Disabled, 1, 2, 4, 8, 10, 20, 30, 40, 50, 60*.

Display Activity

These items specify if the BIOS will monitor the activity of the specified hardware peripheral or component. If set to *Monitor*, any activity detected on the specified hardware peripheral or component will wake up the system or prevent the system from entering the power saving modes. Settings: *Monitor, Ignore*.

CPU Critical Temperature

If the CPU temperature reaches the upper limit preset in this setting, the warning mechanism will be activated. This helps you to prevent the CPU overheating problem.

CPUHALT Command Detection

This item allows your OS to determine whether the CPU will enter the HALT command state. Options: *Enabled, Disabled.*

Power Button Function

This feature sets the function of the power button. Settings are:

- On/Off* The power button functions as normal power off button.
- Suspend* When you press the power button, the computer enters the suspend/sleep mode, but if the button is pressed for more than four seconds, the computer is turned off.

After AC Power Loss

This setting specifies whether your system will reboot after a power failure or interrupt occurs. Available settings are:

- Power Off* Leaves the computer in the power off state.
- Power On* Leaves the computer in the power on state.
- Last State* Restores the system to the previous status before power failure or interrupt occurred.

Set WakeUp Events

Press <Enter> and the following sub-menu appears.



Wake Up On Ring

For this feature to take effect, you need to install a modem card supporting power on function first. When set to Enabled, activity or input signal of the modem will awake the system from S3 (Suspend to RAM) sleep state. Settings: *Disabled, Enabled.*

Wake Up On PME

When set to *Enabled*, the feature allows your system to be awakened from the power saving modes through any event on PME (Power Man-

agement Event). Settings: *Enabled, Disabled*.

Resume On KBC

This item allows the activity of the keyboard to wake up the system from S3 (Suspend to RAM) sleep state. Settings: *Disabled, Any Key, Specific Key*.

Wake-Up Key

This setting allows users to set a wake-up key to recall the system from power saving state. Options: *Any Key, Specific Key*.

Wake-Up Password

This setting allows users to set a password (max. 5 letters) to wake up the system.

Resume On PS/2 Mouse

This item allows the activity of the mouse to wake up the system from S3 (Suspend to RAM) sleep state. Settings: *Disabled, (double-click) Left-button, (double-click) Right-button*.

Resume By Alarm

This is used to enable or disable the feature of booting up the system on a scheduled time/date from the soft off (S5) state. Settings: *Enabled, Disabled*.

Alarm Date/Hour/Minute/Second

If *Resume By Alarm* is set to *Enabled*, the system will automatically resume (boot up) on a specific date/hour/minute/second specified in these fields. Available settings for each item are:

Alarm Date	01 ~ 31, Every Day
Alarm Hour	00 ~ 23
Alarm Minute	00 ~ 59
Alarm Second	00 ~ 59



MSI Reminds You...

If you have changed this setting, you must let the system boot up until it enters the operating system, before this function will work.

PNP/PCI Configurations

This section describes configuring the PCI bus system and PnP (Plug & Play) feature. PCI, or **P**eripheral **C**omponent **I**nterconnect, is a system which allows I/O devices to operate at speeds nearing the speed the CPU itself uses when communicating with its special components. This section covers some very technical items and it is strongly recommended that only experienced users should make any changes to the default settings.

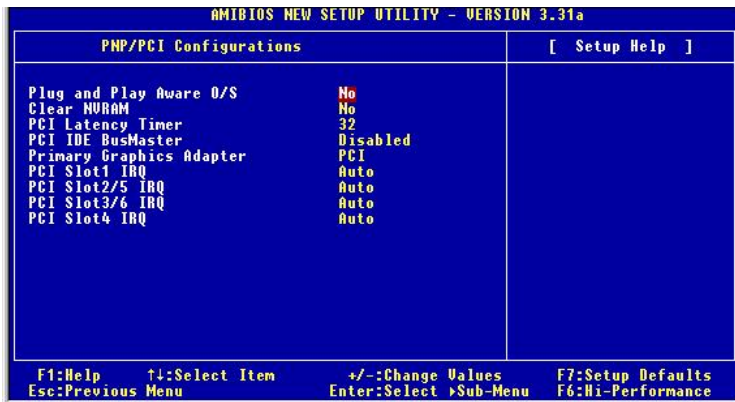

Plug and Play Aware O/S

When set to *Yes*, BIOS will only initialize the PnP cards used for booting (VGA, IDE, SCSI). The rest of the cards will be initialized by the PnP operating system like Windows® 98, 2000 or ME. When set to *No*, BIOS will initialize all the PnP cards. Select *Yes* if the operating system is Plug & Play.

Clear NVRAM

The ESCD (Extended System Configuration Data) NVRAM (Non-volatile Random Access Memory) is where the BIOS stores resource information for both PNP and non-PNP devices in a bit string format. When the item is set to *Yes*, the system will reset ESCD NVRAM right after the system is booted up and then set the setting of the item back to *No* automatically.

PCI Latency Timer

This item controls how long each PCI device can hold the bus before another takes over. When set to higher values, every PCI device can conduct transactions for a longer time and thus improve the effective PCI bandwidth. For better PCI performance, you should set the item to higher values. Settings range from 32 to 248 at a 32 increment.

PCI IDE BusMaster

Set this option to *Enabled* to specify that the IDE controller on the PCI local bus has bus mastering capability. Settings options: *Disabled, Enabled*.

Primary Graphics Adaptor

This setting specifies which VGA card is your primary graphics adapter. Setting options: *PCI, AGP*.

PCI Slot1 IRQ, PCI Slot2/5 IRQ, PCI Slot3/6 IRQ, PCI Slot4 IRQ

These items specify the IRQ line for each PCI slot. Setting options: 3, 4, 5, 7, 9, 10, 11, *Auto*. Selecting *Auto* allows BIOS to automatically determine the IRQ line for each PCI slot.

Integrated Peripherals

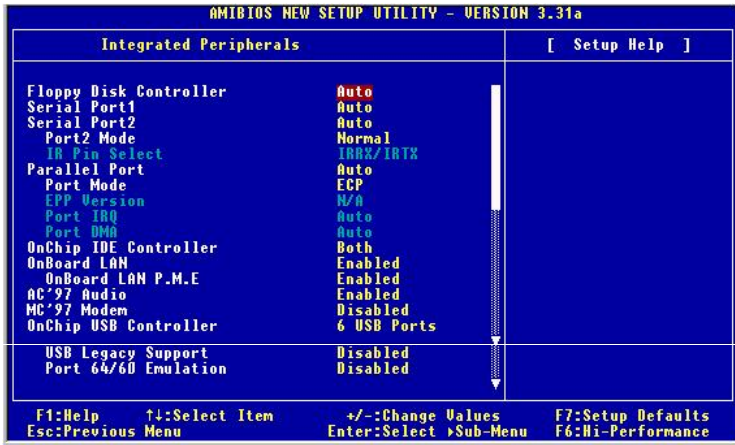

Floppy Disk Controller

This is used to enable or disable the onboard Floppy controller.

Option	Description
Auto	BIOS will automatically determine whether to enable the onboard Floppy controller or not.
Enabled	Enables the onboard Floppy controller.
Disabled	Disables the onboard Floppy controller.

Serial Port 1/2

These items specify the base I/O port addresses of the onboard Serial Port 1 (COM A)/Serial Port 2 (COM B). Selecting *Auto* allows AMIBIOS to automatically determine the correct base I/O port address. Settings: *Auto*, *3F8/COM1*, *2F8/COM2*, *3E8/COM3*, *2E8/COM4* and *Disabled*.

Serial Port2 Mode

This item sets the operation mode for Serial Port 2. Settings: *Normal*, *1.6 uS*, *3/16 Baud* and *ASKIR* (the last three operation modes are setting options for IR function).

IR Pin Select

Set to *IRRX/IRTX* when using an internal IR module connected to the IR header. Set to *SINB/SOUTB*. when connecting an IR adapter to COM B.

Parallel Port

This field specifies the base I/O port address of the onboard parallel port. Selecting *Auto* allows AMIBIOS to automatically determine the correct base I/O port address. Settings: *Auto, 378, 278, Disabled*.

Port Mode

This item selects the operation mode for the onboard parallel port: *ECP, Normal, Bi-Dir* or *EPP*.

EPP Version

The item selects the EPP version used by the parallel port if the port is set to *EPP* mode. Settings: *1.7, 1.9*.

Port IRQ

When *OnBoard Parallel Port* is set to *Auto*, the item shows *Auto* indicating that BIOS determines the IRQ for the parallel port automatically.

Port DMA

This feature needs to be configured only when *Parallel Port Mode* is set to the *ECP* mode. When Parallel Port is set to *Auto*, the field will show *Auto* indicating that BIOS automatically determines the DMA channel for the parallel port.

OnChip IDE Controller

This setting controls the onboard IDE controller. Setting options: *Disabled, Primary, Secondary, Both*.

OnBoard LAN

This setting controls the onboard LAN controller. Setting options: *Disabled, Enabled*.

OnBoard LAN P.M.E.

This feature allows the onboard LAN to be awakened from the power saving modes through any event on PME (Power Management Event). Setting options: *Disabled, Enabled*.

AC'97 Audio

Auto allows the mainboard to detect whether an audio device is used. If an audio device is detected, the onboard AC'97 (Audio Codec'97) controller will be enabled; if not, it is disabled. Disable the controller if you want to use other controller cards to connect an audio device. Settings: *Auto, Disabled*.

MC'97 Modem

Auto allows the mainboard to detect whether a modem is used. If a modem is detected, the onboard AC'97 modem controller will be enabled; if not, it is disabled. Disable the controller if you want to use other controller cards to connect a modem. Settings: *Auto, Disabled*.

OnChip USB Controller

This setting is used to enable/disable the onboard USB ports. Setting options: *Disabled, 2 USB Ports, 4 USB Ports, 6 USB Ports*.

USB Legacy Support

Set to *All Device* if you need to use any USB device in the operating system that does not support or have any USB driver installed, such as DOS and SCO Unix. Set to *No Mice* only if you want to use any USB device other than the USB mouse.

Port 64/60 Emulation

This field controls the USB Port 64/60 Emulation function. When the function is enabled, the USB keyboard is allowed to type some special combination keys. Setting options: *Disabled, Enabled*.

PC Health Status

This section shows the status of your CPU, fan, overall system status, etc. Monitor function is available only if there is hardware monitoring mechanism onboard.

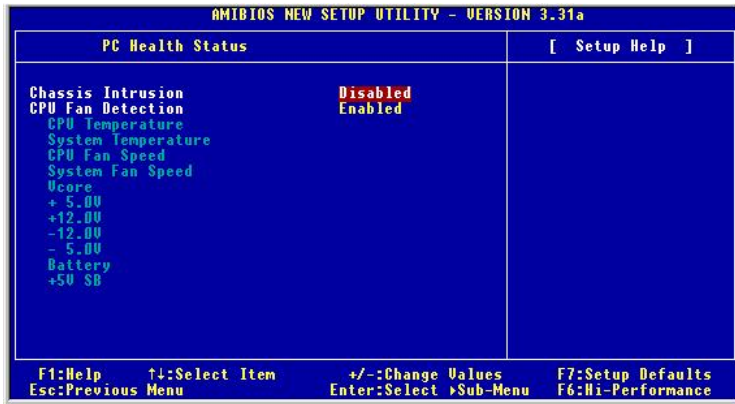

Chassis Intrusion

The field enables or disables the feature of recording the chassis intrusion status and issuing a warning message if the chassis is once opened. To clear the warning message, set the field to *Reset*. The setting of the field will automatically return to *Enabled* later. Settings: *Enabled, Reset, Disabled*.

CPU Fan Detection

When enabled, the system will automatically monitor the CPU fan during boot-up. If it detects that the CPU fan is not rotating, the system will show an error message on the screen and halt the boot-up process. **The function is built with CPU fan power connector (CFAN1) only** and enables you to protect the CPU from possible overheating problem. If you don't connect the CPU fan to the CPU fan power connector, we recommend that you disable the feature. Settings: *Enabled, Disabled*.

CPU/System Temperature, CPU/System Fan Speed, Vcore, +5.0V, +12.0V, -12.0V, -5.0V, Battery, +5V SB

These items display the current status of all of the monitored hardware devices/components such as CPU voltages, temperatures and all fans' speeds.

Frequency/Voltage Control

Use this menu to specify your settings for frequency/voltage control.

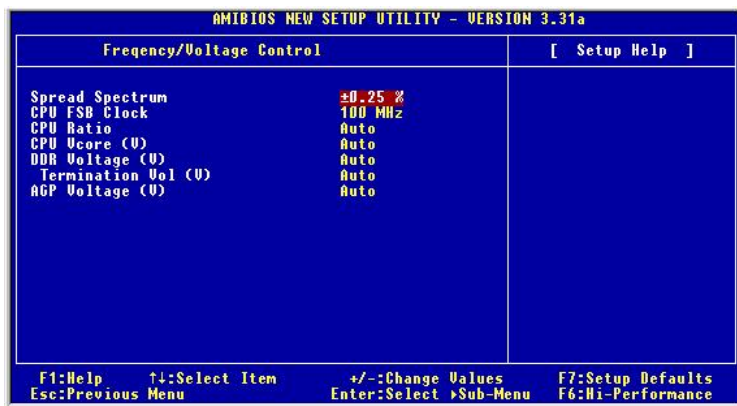

Spread Spectrum

When the motherboard's clock generator pulses, the extreme values (spikes) of the pulses creates EMI (Electromagnetic Interference). The Spread Spectrum function reduces the EMI generated by modulating the pulses so that the spikes of the pulses are reduced to flatter curves. If you do not have any EMI problem, leave the setting at *Disabled* for optimal system stability and performance. But if you are plagued by EMI, select *one of the options* for EMI reduction. Remember to disable Spread Spectrum if you are overclocking because even a slight jitter can introduce a temporary boost in clockspeed which may just cause your overclocked processor to lock up. Available options: $\pm 0.25\%$, $\pm 0.5\%$, $\pm 0.75\%$, *Disabled*.

CPU FSB Clock

This item allows you to select the CPU Front Side Bus clock frequency (in MHz) and overclock the processor by adjusting the FSB clock to a higher frequency. Select the number between *100~280* for needed frequency.

CPU Ratio/Vcore (V)

The settings are used to adjust the CPU clock multiplier (ratio) and CPU corevoltage (Vcore). These settings offer users a tool to overclock the system.



MSI Reminds You...

*Changing CPU Ratio/Vcore could result in the instability of the system; therefore, it is **NOT** recommended to change the default setting for long-term usage.*

DDR Voltage (V)

Adjusting the DDR voltage can increase the DDR speed. Any changes made to this setting may cause a stability issue, so ***changing the DDR voltage for long-term purpose is NOT recommended.***

Termination Vol (V)

The settings are used to adjust the termination voltage. Setting options:
Auto, 1.27, 1.29.

AGP Voltage (V)

AGP voltage is adjustable in the field, allowing you to increase the performance of your AGP display card when overclocking, but the stability may be affected. Setting options: *Auto, 1.6, 1.7, 1.8.*

Set Supervisor/User Password

When you select this function, a message as below will appear on the screen:

[Enter new supervisor password]	[Enter new user password]
-----------------------------------	-----------------------------

Type the password, up to six characters in length, and press <Enter>. The password typed now will replace any previously set password from CMOS memory. You will be prompted to confirm the password. Retype the password and press <Enter>. You may also press <Esc> to abort the selection and not enter a password.

To clear a set password, just press <Enter> when you are prompted to enter the password. A message will show up confirming the password will be disabled. Once the password is disabled, the system will boot and you can enter Setup without entering any password.

When a password has been set, you will be prompted to enter it every time you try to enter Setup. This prevents an unauthorized person from changing any part of your system configuration.

Additionally, when a password is enabled, you can also have AMIBIOS to request a password each time the system is booted. This would prevent unauthorized use of your computer. The setting to determine when the password prompt is required is the PASSWORD CHECK option of the ADVANCED BIOS FEATURES menu. If the PASSWORD CHECK option is set to *Always*, the password is required both at boot and at entry to Setup. If set to *Setup*, password prompt only occurs when you try to enter Setup.



MSI Reminds You...

About Supervisor Password & User Password:

Supervisor password: Can enter and change the settings of the setup menu.

User password: Can only enter but do not have the right to change the settings of the setup menu.

Load High Performance/BIOS Setup Defaults

The two options on the main menu allow users to restore all of the BIOS settings to High Performance defaults or BIOS Setup defaults. The High Performance Defaults are the values set by the mainboard manufacturer for the best system performance but probably will cause a stability issue. The BIOS Setup Defaults are the default values also set by the mainboard manufacturer for stable performance of the mainboard.

When you select Load High Performance Defaults, a message as below appears:

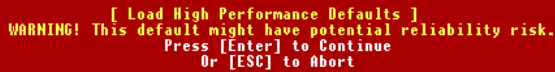

```
[ Load High Performance Defaults ]  
WARNING! This default might have potential reliability risk.  
Press [Enter] to Continue  
Or [ESC] to Abort
```

Pressing 'Enter' loads the default BIOS values that enable the best system performance but may lead to a stability issue.



MSI Reminds You...

The option is for power or overclocking users only. Use of high performance defaults will tighten most timings to increase the system performance. Therefore, a high-end system configuration is a must, which means you need high-quality VGA adapter, RAM and so on. We don't recommend that users should apply the high performance defaults in their regular systems. Otherwise, the system may become unstable or even crash. If the system crashes or hangs after enabling the feature, please CLEAR CMOS DATA to resolve the problem. For more information, refer to "Clear CMOS Jumper:JBAT1" in Chapter 2.

When you select Load BIOS Setup Defaults, a message as below appears:



```
[ Load BIOS Setup Defaults ]  
Press [Enter] to Continue  
Or [ESC] to Abort
```

Pressing 'Enter' loads the default values that are factory settings for stable system performance.

Appendix: Using 4- or 6-Channel Audio Function

The motherboard is equipped with Realtek ALC650 chip, which provides support for 6-channel audio output, including 2 Front, 2 Rear, 1 Center and 1 Subwoofer channel. ALC650 allows the board to attach 4 or 6 speakers for better surround sound effect. The section will tell you how to install and use 4-/6-channel audio function on the board.

TOPICS

<i>Installing the Audio Driver</i>	<i>A-2</i>
<i>Using 4-/6-Channel Audio Function</i>	<i>A-4</i>
<i>Testing the Connected Speakers</i>	<i>A-14</i>
<i>Playing KaraOK</i>	<i>A-16</i>

Installing the Audio Driver

You need to install the driver for Realtek ALC650 chip to function properly before you can get access to 4-/6-channel audio operations. Follow the procedures described below to install the drivers for different operating systems.

Installation for Windows 98SE/ME/2000/XP

For Windows® 2000, you must install Windows® 2000 Service Pack2 or later before installing the driver.

The following illustrations are based on Windows® XP environment and could look slightly different if you install the drivers in different operating systems.

1. Insert the companion CD into the CD-ROM drive. The setup screen will automatically appear.
2. Click **Avance ALC650 Sound Drivers**.

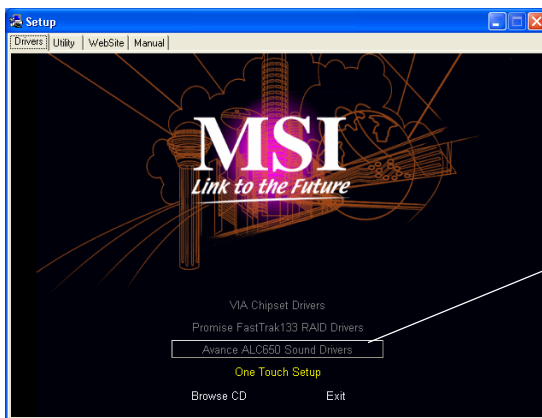

Click here



MSI Reminds You...

*The **AC97 Audio Configuration**  software utility is under continuous update to enhance audio applications. Hence, the program screens shown here in this appendix may be slightly different from the latest software utility and shall be held for reference only.*

3. Click **N**ext to start installing files into the system.

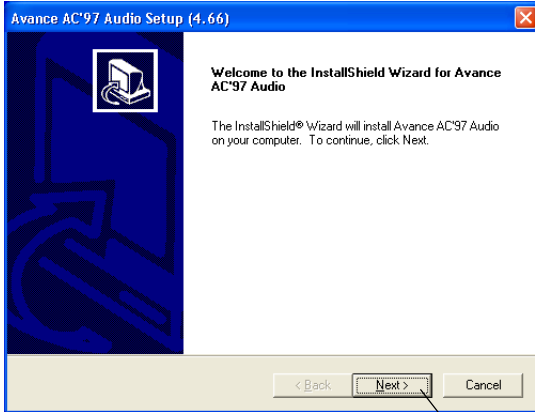

Click here

4. Click **F**inish to restart the system.

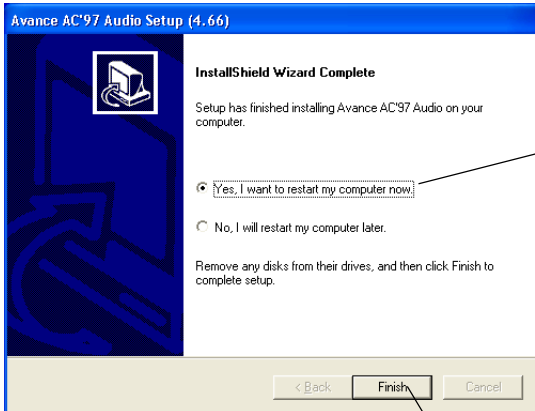

Select this option

Click here

Using 4- or 6-Channel Audio Function

After installing the audio driver, you are able to use the 4-/6-channel audio feature now. To enable 4- or 6-channel audio operation, first connect 4 or 6 speakers to the appropriate audio connectors, and then select 4- or 6-channel audio setting in the software utility.

There are two ways to utilize the function and connect the speakers to your computer:

- **Using the optional S-Bracket**

If your motherboard supports S-Bracket and you have installed S-Bracket in the computer, you can connect two speakers to back panel's Line-Out connector, and the rest of speakers to S-Bracket.

- **Using the back panel only**

If you do not have a S-Bracket, you can connect all speakers to the audio connectors on the back panel.

Using the Optional S-Bracket

S-Bracket integrates the SPDIF (Sony & Philips Digital Interface) and analog LINE OUT connectors together. With this optional accessory, users will be able to decide either analog or digital audio output when applying the speakers to the connectors.

Read the following instructions to have the Multi-Channel Audio Function mode properly set in the software utility, and then have your speakers correctly connected to the S-Bracket:

Configuration in the Software Utility

1. Click the audio icon  from the window tray at the lower-right corner of the screen.
2. Select a desired surround sound effect from the “*Environment*” drop-down menu.
3. Click the *Speaker Configuration* tab.
4. Select a desired multi-channel operation from *No. of Speaker*.
 - a. Headphones Mode for headphone Output
 - b. 2-Channel Mode for Stereo-Speaker Output
 - c. 4-Channel Mode for 4-Speaker Output

d. 6-Channel Mode for 5.1-Speaker Output

5. Select or clear the **Default Phonejack** check box to decide which audio devices you wish to use for audio outputs.

The instructions shown on the **Speaker Configuration** screen may vary depending on how you set the options of **No. of Speaker** and **Default Phonejack**. To ensure proper hardware installation, connect your speakers to the correct phonejacks in accordance with the setting in software utility.

6. Click **OK** to close this window.

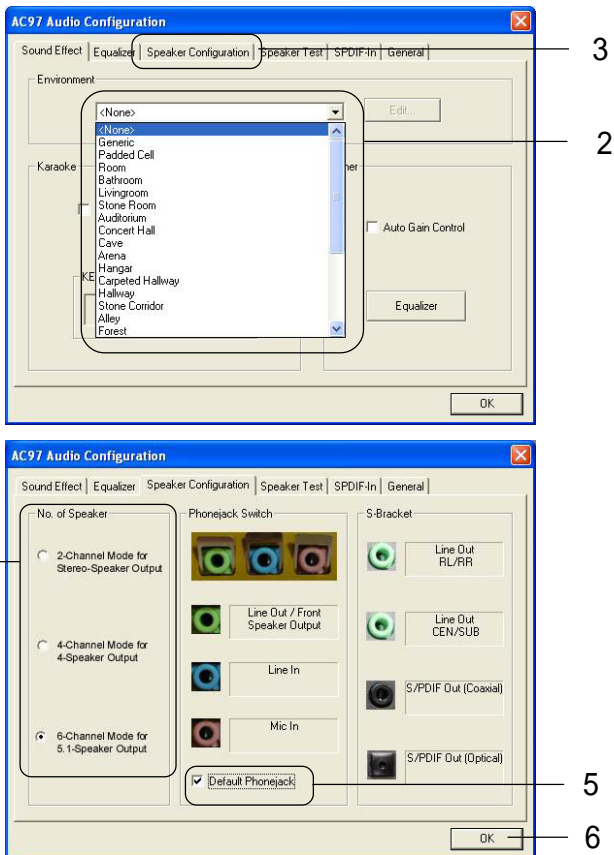

Connecting the Speakers

When you have set the Multi-Channel Audio Function mode properly in the software utility, connect your speakers to the correct phonejacks in accordance with the setting in software utility.

■ 2-Channel Mode for Stereo-Speaker Output

When this mode is selected, it is recommended to attach the speakers to the Line Out connector on the back panel instead of the Line Out connector on the S-Bracket.

Refer to the following diagram and caption for the function of each phonejack on the back panel when 2-Channel mode is selected.

Select “Default Phonejack”

- 2 MIC
- 3 Line In
- 1 Line Out
- 4 Optical SPDIF jack
- 5 Coaxial SPDIF jack

Deselect “Default Phonejack”

- 2 MIC
- 3 Line In
- 1 Line Out
- 4 Optical SPDIF jack
- 5 Coaxial SPDIF jack

Back Panel

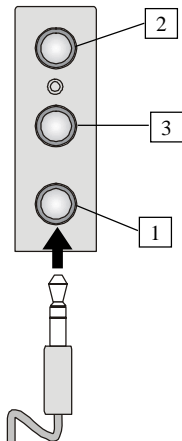

S-Bracket

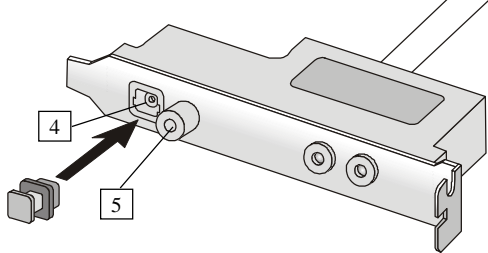

MSI Reminds You...

When any Multi-Channel Audio Mode is selected, you may also connect your speakers to the Optical or Coaxial SPDIF phonejack on the S-Bracket to experience digital surround sound effect.

■ **4-Channel Mode for 4-Speaker Output**

When this mode is selected, plug the two front speakers to the Line Out connector on the back panel, and the other two rear speakers to the Line Out connector on the S-Bracket.

Refer to the following diagram and caption for the function of each phonejack on the back panel and S-Bracket when 4-Channel mode is selected.

Select “Default Phonejack”

- 2 MIC
- 3 Line In
- 1 Front Speaker Out (*Front channels*)
- 4 Optical SPDIF jack
- 5 Coaxial SPDIF jack
- 6 Line Out (*Reserved for Center and Subwoofer channel, but it is not functioning here*)
- 7 Line Out (*Rear channels*)

Deselect “Default Phonejack”

- 2 MIC
- 3 Rear Speaker Out (*Rear channels*)
- 1 Front Speaker Out (*Front channels*)
- 4 Optical SPDIF jack
- 5 Coaxial SPDIF jack
- 6 Line Out (*Reserved for Center and Subwoofer channel, but it is not functioning here*)
- 7 Line Out (*Rear channels*)

Back Panel

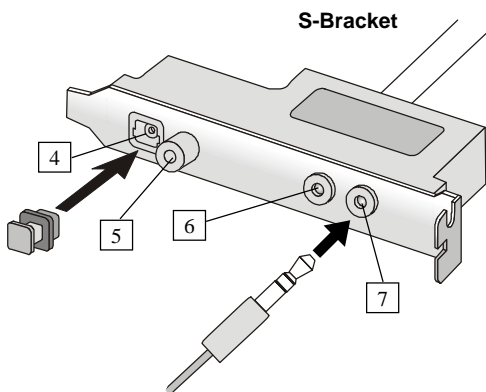
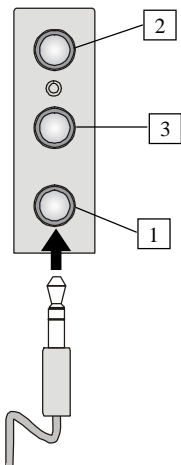

■ 6-Channel Mode for 6-Speaker Output

When this mode is selected, plug the two front speakers to the Line Out connector on the back panel, and the other two rear speakers to the Line Out connector on the S-Bracket.

Refer to the following diagram and caption for the function of each phonejack on the back panel and S-Bracket when 6-Channel mode is selected.

Select “Default Phonejack”

- 2 MIC
- 3 Line In
- 1 Front Speaker Out (*Front channels*)
- 4 Optical SPDIF jack
- 5 Coaxial SPDIF jack
- 6 Line Out (*Center and Subwoofer channels*)
- 7 Line Out (*Rear channels*)

Deselect “Default Phonejack”

- 2 Center/Subwoofer Speaker Out (*Center and Subwoofer channels*)
- 3 Rear Speaker Out (*Rear channels*)
- 1 Front Speaker Out (*Front channels*)
- 4 Optical SPDIF jack
- 5 Coaxial SPDIF jack
- 6 Line Out (*Center and Subwoofer channels*)
- 7 Line Out (*Rear channels*)

Back Panel

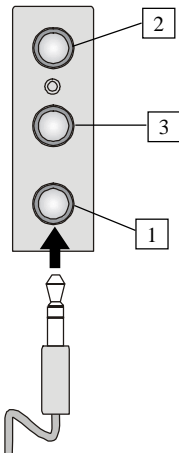

S-Bracket

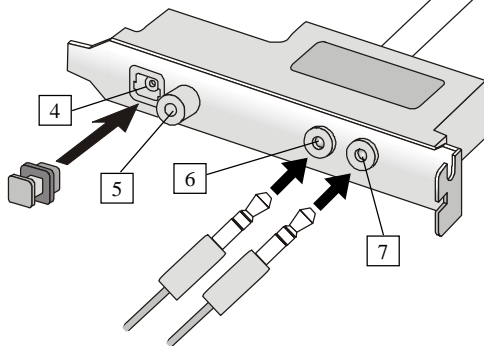

MSI Reminds You...

If the Center and Subwoofer speaker exchange their audio channels when you play video or music on the computer, a converter may be required to exchange center and subwoofer audio signals. You can purchase the converter from a speaker store.

■ Digital Audio Output

When any Multi-Channel Audio Function mode is selected, you may also connect your speakers to the Optical or Coaxial SPDIF phonejack on the S-Bracket to experience digital surround sound effect.

Remove the plug from the optical SPDIF phonejack before inserting the fiber-optic cable, and read the following diagram and captions for the function of each phonejack on the S-Bracket.

- 1 Optical SPDIF jack
- 2 Coaxial SPDIF jack

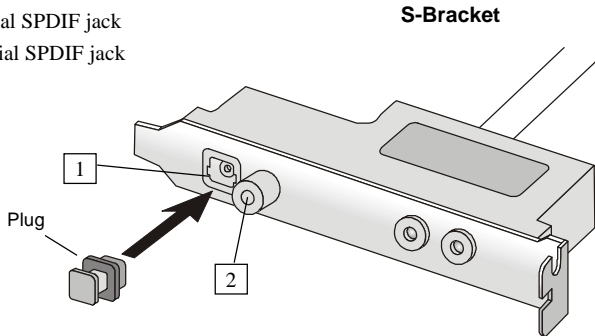

MSI Reminds You...

Some commonly-used audio output formats (midi, wav,...etc.) may not be able to be output from the SPDIF jacks of the S-Bracket. To convert these audio formats as SPDIF output:

1. Click the **Volume Control** icon at the taskbar (or go to Control Panel/Sounds and Audio Devices/Volume Control).
2. Click **Properties** on the **Options** menu. Under **Adjust volume for**, click **Playback**, and select the **SPDIF** check box in the **Show the following volume controls** list.
3. Click **Advanced Controls for SPDIF** on the **Options** menu. Under **Other Controls**, select the **Sampling rate conversion for SPDIF output** check box.
4. Click **Close** to exit **Volume Control**.

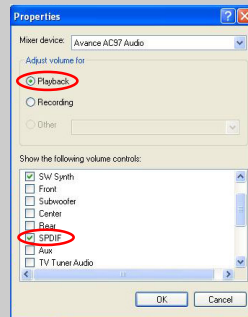

Using the Back Panel only

In addition to a default 2-channel analog audio output function, the audio connectors on the Back Panel also provide 4- or 6-channel analog audio output function if a proper setting is made in the software utility.

Read the following steps to have the Multi-Channel Audio Function properly set in the software utility, and have your speakers correctly connected to the Back Panel.

Configuration in the Software Utility

1. Click the audio icon  from the window tray at the lower-right corner of the screen.
2. Select a desired surround sound effect from the “Environment” drop-down menu.
3. Click the **Speaker Configuration** tab.
4. Select **Synchronize the phonejack switch with the settings**.
5. Select a desired multi-channel operation from **No. of Speakers**.
 - a. 2-Channel Mode for Stereo-Speaker Output
 - b. 4-Channel Mode for 4-Speaker Output
 - c. 6-Channels Mode for 5.1-Speaker Output
6. Click **OK** to close this window.

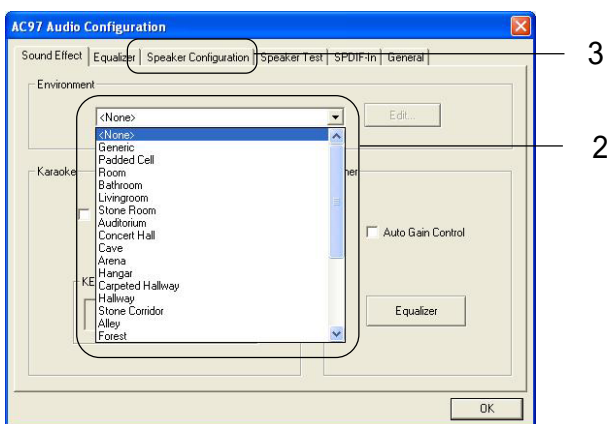

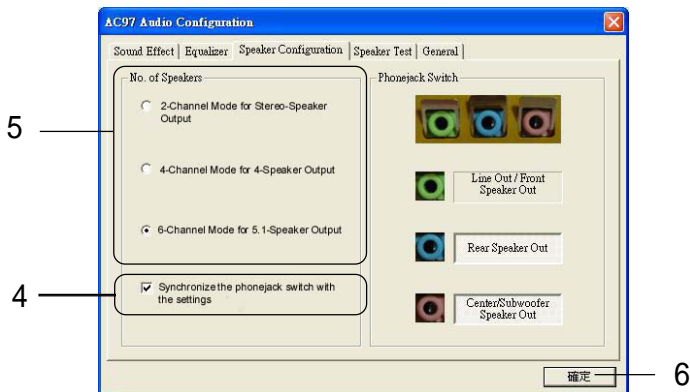

Connecting the Speakers

When you have set the Multi-Channel Audio Function mode properly in the software utility, connect your speakers to the correct phonejacks in accordance with the setting in software utility.

■ 2-Channel Mode for Stereo-Speaker Output

Refer to the following diagram and caption for the function of each phonejack on the back panel when 2-Channel Mode is selected.

- 2 MIC
- 3 Line In
- 1 Line Out (*Front channels*)

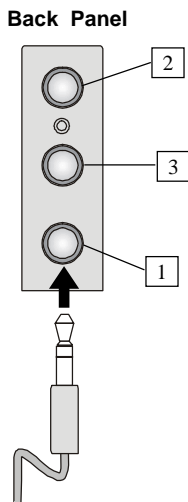

■ **4-Channel Mode for 4-Speaker Output**

The audio jacks on the back panel always provide 2-channel analog audio output function, however these audio jacks can be transformed to 4- or 6- channel analog audio jacks by selecting the corresponding multi-channel operation from **No. of Speakers**.

Refer to the following diagram and caption for the function of each jack on the back panel when 4-Channel Mode is selected.

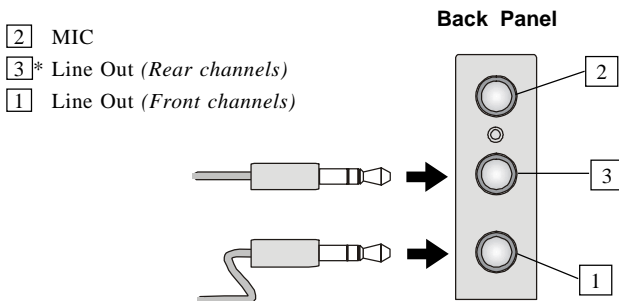

* Line In function is converted to Line Out function when 4-Channel Mode for 4-Speaker Output is selected.

■ 6-Channel Mode for 6-Speaker Output

Refer to the following diagram and caption for the function of each jack on the back panel when 6-Channel Mode is selected.

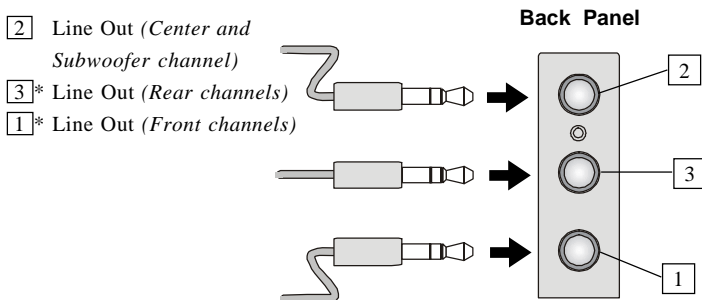

* Both Line In and MIC function are converted to Line Out function when 4-Channel Mode for 6-Speaker Output is selected.



MSI Reminds You...

If the Center and Subwoofer speaker exchange their audio channels when you play video or music on the computer, a converter may be required to exchange center and subwoofer audio signals. You can purchase the converter from a speaker store.

Testing the Connected Speakers

To ensure that 4- or 6-channel audio operation works properly, you may need to test each connected speaker to make sure every speaker work properly. If any speaker fails to sound, then check whether the cable is inserted firmly to the connector or replace the bad speakers with good ones.

Testing Each Speaker

1. Click the audio icon  from the window tray at the lower-right corner of the screen.
2. Click the **Speaker Test** tab.
3. The following window appears. Select the speaker which you want to test by clicking it.

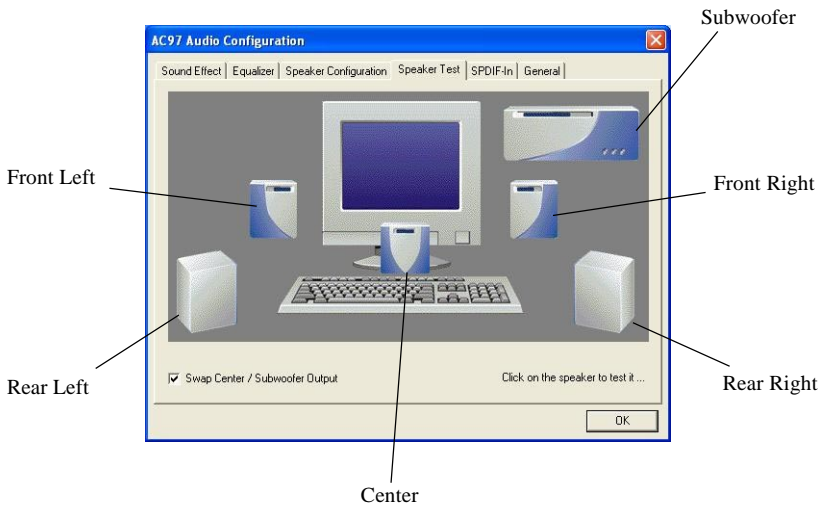

MSI Reminds You...

6 speakers appear on the "Speaker Test" window only when you select "6-Channel Mode" in the "No. of Speakers" column. If you select "4-Channel Mode", only 4 speakers appear on the window.

4. While you are testing the speakers in 6-Channel Mode, if the sound coming from the center speaker and subwoofer is swapped, you should select **Swap Center/Subwoofer Output** to readjust these two channels.



Select this function

Playing KaraOK

The KaraOK function will automatically remove human voice (lyrics) and leave melody for you to sing the song. Note that this function applies only for 2-channel audio operation.

Playing KaraOK

1. Click the audio icon  from the window tray at the lower-right corner of the screen.
2. In the Sound Effect tab, select **Voice Cancellation** under “KaraOK.”
3. Click **OK** to close this window.

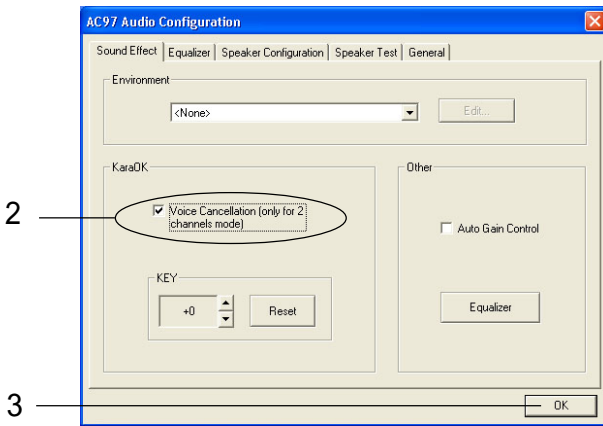

Troubleshooting

Q: How do I know that the product that I have is from MSI?

A: All MSI product starts with the character MS-XXXX or Marketing Name (MS-XXXX) wherein XXXX refers to numbers. You should be able to find the Model number in between the PCI slots. For Example: MS-6368 or 845E Max(MS-6566E)

Q: How do I identify the BIOS version?

A: Upon boot-up, the 1st line appearing after the memory count is the BIOS version. It is usually in the format:

A6380MS V1.0 091096 where:

1st digit refers to BIOS maker as A = AMI(R) W = AWARD(R)

2nd - 5th digit refers to the model number.

6th - 7th digit refers to the customer as MS = all standard customers.

V1.0 refers to the BIOS version.

091096 refers to the date this BIOS is released.

Q: Does BIOS update need to be done by one version sequentially (3.0-->3.1-->3.2-->3.3) or can I update directly to the last version (3.3)?

A: You can update directly to the latest one

Q: Should I update my BIOS, once a new BIOS is released?

A: A new BIOS is usually released due to the following reasons:

1. New function is supported
2. New BIOS source code
3. Bugs are found
4. Customer-specific request

When we release a new BIOS, there's usually a release note attached which lists the reason for the release. Refer to this release note and decide

for yourself if upgrading to the new BIOS will be worth it. A word of advice, though, do not upgrade to the new BIOS, unless you really have to.

Q: How can I update my BIOS?

A: For **Award** BIOS, refer to <http://www.msi.com.tw/html/support/bios/note/award.htm>

For **AMI** BIOS, refer to <http://www.msi.com.tw/html/support/bios/note/ami.htm>

For user using non-FAT system, refer to <http://www.msi.com.tw/html/support/bios/note/ntfs.htm>

Q: After flashing the BIOS, my system for unknown reason dont want to boot, what should I do?

A: Normally, this should not happen unless you flashed the wrong BIOS or some other reasons.

Suggestions:

1. try the BIOS boot recovery feature as described in <http://www.msi.com.tw/html/support/bios/note/boot.htm>
2. try to clear the CMOS

If problem still persists, you would need to purchase new BIOS chip from Websites like www.flashbios.org where you can order a new BIOS or you can also contact MSI office near your place to purchase new BIOS chip <http://www.msi.com.tw/html/contact/contact.htm>

Q: Why my motherboard BIOS sticker is "Phoenix BIOS" but when I boot up my system I saw that "Award BIOS" is being used?

A: Phoenix & Award already merged as one company. All MSI motherboard using Award BIOS comes with Phoenix logo sticker.

Q: Where can I find the BIOS for my motherboard?

A: 1. For Server motherboard, refer to <http://www.msi.com.tw/program/>

support/bios/bos/spt_bos_list.php?kind=3

2. For Desktop motherboard, refer to http://www.msi.com.tw/program/support/bios/bos/spt_bos_list.php?kind=1

Note: The BIOS is subdivided as Socket478, SocketA, Socket 470 & Archives

If your board is socket478 based board, then you should be able to find your board under the socket478 area

If in case you cannot find your board, then refer to http://www.msi.com.tw/program/support/bios/bos/spt_bos_list.php?kind=1&CHIP=Archives&ID=4 and find your board according to the CPU type

3. For Optical product firmware, refer to http://www.msi.com.tw/program/support/driver/dvr/spt_dvr_list.php?part=4

Q: Where can I find MSI developed software such as Fuzzy Logic or PC Alert?

A: Refer to http://www.msi.com.tw/program/support/software/swr/spt_swr_list.php

Q: Where can I find the manual?

A: 1. For Desktop motherboard, refer to http://www.msi.com.tw/program/support/manual/mnu/spt_mnu_list.php

Note: The manual is subdivided as Socket478, SocketA, Socket 470 & Archives

If your board is socket478 based board, then you should be able to find your board under the socket478 area

If in case you cannot find your board, then refer to http://www.msi.com.tw/program/support/manual/mnu/spt_mnu_list.php?kind=1&CHIP=Archives&ID=4 & find your board according to the CPU type

2. For VGA card, refer to http://www.msi.com.tw/program/support/manual/mnu/spt_mnu_list.php?kind=3

Note: The manual is subdivided as Geforce4, Geforce3, Geforce2 & Archives

If your VGA is Geforce4 based card, then you should be able to find your card under the Geforce4 area

If in case you cannot find your card, then refer to http://www.msi.com.tw/program/support/manual/mnu/spt_mnu_list.php?kind=2&CHIP=Archives&ID=4 & find your card according to the chipset type

2. For Server motherboard, refer to http://www.msi.com.tw/program/support/manual/mnu/spt_mnu_list.php?kind=3

3. For peripherals like PC2PC bluetooth or TV Tuner, refer to http://www.msi.com.tw/program/support/manual/mnu/spt_mnu_list.php?kind=7

Q: Where can I find the drivers?

A: Please refer to the following suggestions: 1. Try the BIOS boot recovery feature as described in <http://www.msi.com.tw/support/bios/boot.htm>
2. Try to clear the CMOS If problem still persists, ask your reseller for new BIOS chip or contact one of MSI office near your place for new BIOS chip <http://www.msi.com.tw/contact/main.htm>

Q: Should I update my BIOS, once a new BIOS is released?

A: 1. For Desktop motherboard, refer to http://www.msi.com.tw/program/support/driver/dvr/spt_dvr_list.php where the drivers are divided according to chipset, on-board LAN, on-board VGA, on-board audio, on-board IDE, on-board SCSI & etc.

2. For VGA card, refer to http://www.msi.com.tw/program/support/driver/dvr/spt_dvr_list.php?part=2 where the drivers are divided according to video drivers, capture drivers & others

3. For Server motherboard, refer to <http://www.msi.com.tw/program/>

[support/driver/dvr/spt_dvr_list.php?part=3](http://www.msi.com.tw/program/support/driver/dvr/spt_dvr_list.php?part=3)

4. For Optical product firmware, refer to http://www.msi.com.tw/program/support/driver/dvr/spt_dvr_list.php?part=4

5. For MSI special product like bluetooth or TV tuner, refer to http://www.msi.com.tw/program/support/driver/dvr/spt_dvr_list.php?part=5

Q: How can I know what CPU can my motherboard support?

A: 1. For Server motherboard, refer to http://www.msi.com.tw/program/support/cpu_support/cpu/spt_cpu_list.php?kind=3

2. For Desktop motherboard, refer to http://www.msi.com.tw/program/support/cpu_support/cpu/spt_cpu_list.php?kind=1

Note: The BIOS is subdivided as Socket478, SocketA, Socket 470 & Archives

If your board is socket478 based board, then you should be able to find your board under the socket478 area

If in case you cannot find your board, then refer to http://www.msi.com.tw/program/support/cpu_support/cpu/spt_cpu_list.php?kind=1&CHIP=Archives&ID=4 & find your board according to the CPU type

Note: On some CPU table you will see N/A, N/A means not applicable or not supported

Q: Where can I get my motherboard repaired since it is not working?

A: The normal procedure is to contact your reseller (the place you bought the board from) for repair/exchange. If the reseller for some reason like bankrupt cannot be contacted, then contact MSI distributor <http://www.msi.com.tw/program/contact/where2buy/> or MSI office near your place <http://www.msi.com.tw/html/contact/contact.htm>

Q: My reseller went bankrupt, where can I send back my board for repair?

A: Contact MSI distributor <http://www.msi.com.tw/program/contact/where2buy/> or MSI office near your place <http://www.msi.com.tw/html/contact/contact.htm>

Q: How long is MSI motherboard warranty?

A: MSI normally gives 2 years warranty to its direct customer & distributors. But each distributor & reseller will have a different warranty policy. So it is advisable you check with your reseller about their warranty policy.

Q: How can I find MSI distributor in my country?

A: Refer to <http://www.msi.com.tw/program/contact/where2buy/> Select the country & you will find MSI distributor in that country. If in case you cannot find the country listed, then it means MSI still doesn't have distributor in the said country

Q: How can I find MSI office near my country?

A: Refer to <http://www.msi.com.tw/html/contact/contact.htm>
For more information of each MSI subsidiary company, please move your mouse arrow to the "+" symbol.

Q: My system cannot boot up, what shall I do?

A: There are many possibilities on why the system cannot boot up, please refer to below suggestions to see if it helps or not. If after trying below suggestions problem still persists, then take the motherboard to the place you bought from & have them take a look to make sure if the motherboard is faulty or not

Suggestions:

Make sure the motherboard was installed properly to the chassis (the board should not touch the chassis)

Make sure all the components (memory, CPU, AGP & power supply connectors etc.) are properly installed

Clear CMOS

Change to another power supply

Change to another memory

Change to another AGP card

Q: What should I do if my motherboard have compatibility issue with PCI cards?

A: Suggestions

Remove all the unnecessary devices & try to find the source of the problem

Disable all on-board device like audio, RAID or others apply & see if it is due to resource conflict

Move the PCI card to different PCI slots

Update the card BIOS or drivers

Update the motherboard BIOS

Q: What should I do if my MSI VGA card have compatibility issue with another brand of motherboard?

A: Update the video driver

Update the motherboard driver or BIOS

Glossary

ACPI (*Advanced Configuration & Power Interface*)

This power management specification enables the OS (operating system) to control the amount of power given to each device attached to the computer. Windows 98/98SE, Windows 2000 and Windows ME can fully support ACPI to allow users managing the system power flexibly.

AGP (*Accelerated Graphics Port*)

A new, high-speed graphics interface that based on PCI construction and designed especially for the throughput demands of 3-D graphics. AGP provides a direct channel (32-bit wide bus) between the display controller and main memory for high graphics quality and performance.

Bluetooth

Bluetooth refers to a worldwide standard for the wireless exchange of data between two devices. Bluetooth requires that a low-cost transceiver chip be included in each device. The transceiver transmits and receives in a previously unused frequency band of 2.45 GHz that is available globally (with some variation of bandwidth in different countries). In addition to data, up to three voice channels are available. Each device has a unique 48-bit address from the IEEE 802 standard. Connections can be point-to-point or multipoint. The maximum range is 10 meters. Data can be exchanged at a rate of 1 megabit per second (up to 2 Mbps in the second generation of the technology).

BIOS (*Basic Input/Output System*)

On PCs, an essential software that contains all the control code of input/output interface (such as keyboard, disk drives, etc.). It executes hardware test on booting the system, starts the OS, and provides an interface between the OS and the components. The BIOS is stored in a ROM chip.

Bus

A set of hardware lines within the computer system, through which the data is transferred among different components. In a PC, the term **bus** usually refers to a local bus that connects the internal components to the CPU and main memory.

Cache

A special memory subsystem that is used to speed up the data transfer. It stores the

contents of frequently accessed RAM locations and the addresses where these data items are stored.

Chipset

A collection of integrated chips designed to perform one or more related functions. For example, a modem chipset contains all the primary circuits for transmitting and receiving data; a PC chipset provides the electronic interfaces between all subsystems.

Clock Cycle

Clock cycle (or tick) is the smallest unit of time recognized by a device. For personal computers, clock cycles generally refer to the main system clock, which runs at 66 MHz. This means that there are 66 million clock cycles per second. Since modern CPUs run much faster (up to 533 MHz), the CPU can execute several instructions in a single clock tick.

CMOS (*Complementary Metal-Oxide Semiconductor*)

CMOS is a widely used type of semiconductor, which features high speed and low power consumption. PCs usually contain a small amount of battery-powered CMOS memory to retain the date, time, and system setup parameters.

DRAM (*Dynamic RAM*)

A most common type of computer memory. It usually uses one transistor and a capacitor to represent a bit. As the development of technology, the memory type and specification used in computer becomes variety, such as SDRAM, DDR SDRAM, and RDRAM. For further instruction, please see the table below:

Dynamic RAM (DRAM) Memory Technologies					
Type	First Used	Clock Rate	Bus* Width	Peak Bandwidth	Volts
FPM (60,70ns)	1990	25MHz	64 bits	200 MBps	5v
EDO (50,60,70ns)	1994	40MHz	64 bits	320 MBps	5v
SDRAM (66MHz)	1996	66MHz	64 bits	528 MBps	3.3v
SDRAM (100MHz)	1998	100MHz	64 bits	800 MBps	3.3v
SDRAM (133MHz)	1999	133MHz	64 bits	1.1 GBps	3.3v
RDRAM (Direct Rambus)	1999	400MHz	16 bits	1.6 GBps	2.5v
DDR SDRAM (100MHz)	2000	100MHz	64 bits	1.6 GBps	3.3v
DDR SDRAM (133MHz)	2000	133MHz	64 bits	2.1 GBps	3.3v

* Memory channel width (64 bits started with 75MHz Pentium)

Source: *Computer Desktop Encyclopedia*

ECC Memory (*Error Correcting Code Memory*)

A type of memory that contains special circuitry for testing the accuracy of data and correcting the errors on the fly.

EEPROM

Acronym for Electrically Erasable Programmable Read-Only Memory. An EEPROM is a special type of PROM that can be erased by exposing it to an electrical charge. Like other types of PROM, EEPROM retains its contents even when the power is turned off. Also like other types of ROM, EEPROM is not as fast as RAM. EEPROM is similar to flash memory (sometimes called flash EEPROM). The principal difference is that EEPROM requires data to be written or erased one byte at a time whereas flash memory allows data to be written or erased in blocks. This makes flash memory faster.

EIDE

Short for Enhanced IDE, a newer version of the IDE mass storage device interface standard developed by Western Digital Corporation. It supports data rates of between 4 and 16.6 MBps, about three to four times faster than the old IDE standard. In addition, it can support mass storage devices of up to 8.4 gigabytes, whereas the old standard was limited to 528 MB. Because of its lower cost, enhanced EIDE has replaced SCSI in many areas. There are four EIDE modes defined. The most common is Mode 4, which supports transfer rates of 16.6 MBps. There is also a new mode, called ATA-3 or Ultra ATA, that supports transfer rates of 33 MBps.

EISA (*Extended Industry Standard Architecture*)

EISA is a standard bus (computer interconnection) architecture that extends the ISA standard to a 32-bit interface. It was developed in part as an open alternative to the proprietary Micro Channel Architecture (MCA) that IBM introduced in its PS/2 computers. EISA data transfer can reach a peak of 33 megabytes per second.

ESCD (*Extended System Configuration Data*)

It is a format for storing information about Plug-and-Play (PnP) devices in the BIOS. Windows and the BIOS access the ESCD area each time you re-boot your computer

External Cache

Short for Level 2 cache, cache memory that is external to the microprocessor. In general, L2 cache memory, also called the secondary cache, resides on a separate chip from the microprocessor chip. Although, more and more microprocessors are including L2 caches into their architectures.

IDE (*Integrated Drive Electronics*)

A type of disk-drive interface widely used to connect hard disks, CD-ROMs and tape drives to a PC, in which the controller electronics is integrated into the drive itself, eliminating the need for a separate adapter card. The IDE interface is known as the ATA (AT Attachment) specification.

IEEE 1394

A new, high speed external bus standard, also known as *FireWire* or *iLink*, which supports data transfer rates of up to 400 Mbps for connecting up to 63 external devices.

Internal Cache

Short for Level 1 cache, a memory cache built into the microprocessor. The L1 cache is also called the primary cache.

IrDA (*Infrared Data Association*)

A group of device vendors, including computer, component and telecommunications, who have developed a standard for transmitting data via infrared light waves. This enables you to transfer data from one device to another without any cables.

IRQ (*Interrupt Request Line*)

IRQs are hardware lines over which devices can send interrupt signals to the microprocessor. When you add a new device to a PC, you sometimes need to set its IRQ number by setting a DIP switch. This specifies which interrupt line the device may use. IRQ conflicts used to be a common problem when adding expansion boards, but the Plug-and-Play specification has removed this headache in most cases.

ISA (*Industry Standard Architecture*)

ISA is a standard bus (computer interconnection) architecture that is associated with the IBM AT motherboard. It allows 16 bits at a time to flow between the motherboard circuitry and an expansion slot card and its associated device(s). Also see EISA and MCA.

LAN (*Local Area Network*)

A computer network that covers a relatively smaller area, such as in a building or an enterprise. It is made up of servers, workstations, shared resources, a network operating system and a communications link. These individual PCs and devices on a LAN are known as “nodes”, and are connected by cables to access data and devices anywhere on the LAN, so that many users can share expensive devices and data.

LBA (*Logical Block Addressing*)

Logical block addressing is a technique that allows a computer to address a hard disk larger than 528 megabytes. A logical block address is a 28-bit value that maps to a specific cylinder-head-sector address on the disk. 28 bits allows sufficient variation to specify addresses on a hard disk up to 8.4 gigabytes in data storage capacity. Logical block addressing is one of the defining features of Enhanced IDE (EIDE), a hard disk interface to the computer bus or data paths.

LED (*Light Emitting Diode*)

A semiconductor device that converts electrical energy into light. Since it lights up (usually red) when electricity is passed through it, it is usually used for the activity lights on computer's component, such as disk drivers.

LPT (*Line Printer Terminal*)

Logical device name for a line printer; a name reserved by the MS-DOS for up to three parallel printer ports: LPT1, LPT2, and LPT3. It is frequently used by the OS to identify a printer.

Overclocking

Overclocking is resetting your computer so that the microprocessor runs faster than the manufacturer-specified speed (for example, setting an Intel 166 MHz (megahertz) microprocessor to run at 200 Mhz).

PCI (*Peripheral Component Interconnect*)

A local bus standard developed by Intel that first appeared on PCs in late 1993. PCI provides "plug and play" capability and allows IRQs to be shared. The PCI controller can exchange data with the system's CPU either 32 bits or 64 bits at a time.

PnP (*Plug and Play*)

A set of specifications that allows a PC to configure itself automatically to work with peripherals. The user can "plug" in a peripheral device and "play" it without configuring the system manually. To implement this useful feature, both the BIOS that supports PnP and a PnP expansion card are required.

POST (*Power On Self Test*)

During booting up your system, the BIOS executes a series of diagnostic tests, include checking the RAM, the keyboard, the disk drives, etc., to see if they are properly connected and operating.

PS/2 Port

A type of port developed by IBM for connecting a mouse or keyboard to a PC. The PS/2 port supports a mini DIN plug containing just 6 pins. Most modern PCs equipped with PS/2 ports so that the special port can be used by another device, such as a modem.

RAID

RAID (Redundant Array of Independent Disks; originally Redundant Array of Inexpensive Disks) is a way of storing the same data in different places (thus, redundantly) on multiple hard disks. By placing data on multiple disks, I/O operations can overlap in a balanced way, improving performance. Since multiple disks increases the mean time between failure (MTBF), storing data redundantly also increases fault-tolerance.

SCSI

Acronym for Small Computer System Interface. Pronounced "scuzzy," SCSI is a parallel interface standard used by Apple Macintosh computers, PCs, and many UNIX systems for attaching peripheral devices to computers. SCSI interfaces provide for faster data transmission rates (up to 80 megabytes per second) than standard serial and parallel ports. In addition, you can attach many devices to a single SCSI port, so that SCSI is really an I/O bus rather than simply an interface.

USB (*Universal Serial Bus*)

A hardware interface for low-speed peripherals such as the keyboard, mouse, joystick, etc. USB provides a maximum bandwidth of 12 Mbit/sec (Mbps) for connecting up to 127 peripheral devices to PC. USB features hot swap capability and multiple data streams, allows external devices to be plugged in and unplugged without turning the system off.

Virus

A program or a piece of code that infects computer files by inserting in those files copies of itself. The virus code is buried within an existing program, and is activated when that program is executed. All the viruses are man-made, and often have damaging side effects.

WLAN

Acronym for wireless local-area network. Also referred to as LAWN. A type of local-area network that uses high-frequency radio waves rather than wires to communicate between nodes.

Recommended DDR400 Modules

MS-6712 V:1.0A	XCOPYx2 +VCD+Speedy	3D Mark2001SE v330 Demo Mode	Suspender S3 Mode	Windows Reboot	Windows Shutdown
PC3200 (DDR400) x 1	Play 12hr	Looping 12hr	100 Times	100 Times	100 Times
Samsung 128M (K4H280838E-TCC4)	OK	OK	OK	OK	OK
Micron 256M (MT46V16M8-5TB ES)	OK	OK	OK	OK	OK

MS-6712 V:1.0A	XCOPYx2 +VCD+Speedy	3D Mark2001SE v330 Demo Mode	Suspender S3 Mode	Windows Reboot	Windows Shutdown
PC3200 (DDR400) x 2	Play 12hr	Looping 12hr	100 Times	100 Times	100 Times
Samsung 128M (K4H280838E-TCC4)	OK	OK	OK	OK	OK
Micron 256M (MT46V16M8-5TB ES)	OK	OK	OK	OK	OK

MS-6712 V:1.0A	XCOPYx2 +VCD+Speedy	3D Mark2001SE v330 Demo Mode	Suspender S3 Mode	Windows Reboot	Windows Shutdown
PC3200 (DDR400) x 3	Play 12hr	Looping 12hr	100 Times	100 Times	100 Times
Samsung 256M (K4H560838D-TCC4)	OK	OK	OK	OK	OK

Please visit the MSI Web site for the latest update on *Recommended DDR400 Modules*.

MS-6712 ATX Mainboard

MS-6712 V:1.0A	Test item	
	Business Winstone 2001	Tmem
PC3200 (DDR400) x 2		
Infineon 128M (HYS64D16301GU-5-B) HYB25D256160BT-5	OK	OK
Infineon 256M (HYS64D32300GU-5-B) HYB25D256800BT-5	OK	OK
MICRON 256M (MT16VDDT3264AG-403B4 US) MT46V16M8TG-5 ES B	OK	OK
Winbond 256M (W9425GCDB-5) W942508CH-5	OK	OK
Winbond 256M (Kingston KVR400X64C25/256) W942508BH-5	OK	OK
SEC 256M (M368L3223DTM-CC4) K4H560838D-TCC4	OK	OK
CORSAIR 256M (CMX256A-3200C2) XMS3200V1.1	OK	OK
CORSAIR 256M (CMX256A-3500C2PT) XMS3502 V1.1	OK	OK
SEC 256M (Apacer) K4H560838D-TCC4	OK	OK
HYNIX 256M HY5DU56822AT-D43	OK	OK
Winbond 512M (W9451GCDB-5) W942508CH-5	OK	OK
Winbond 512M (Kingston KVR400X64C25/512) W942508BH-5	OK	OK
SEC 512M (M368L6423DTM-CC4) K4H560838D-TCC4	OK	OK
CORSAIR 512M (CMX512-3500C2PT) XMS3502V1.1	OK	OK

MS-6712 V:1.0A	Test item	
PC3200 (DDR400) x 3	Business Winstone 2001	Tmem
Infineon 128M (HYS64D16301GU-5-B) HYB25D256160BT-5	OK	OK
MICRON 256M (MT16VDDT3264AG-403B4 US) MT46V16M8TG-5 ES B	OK	OK
Winbond 256M (W9425GCDB-5) W942508CH-5	OK	OK
Winbond 256M (Kingston KVR400X64C25/256) W942508BH-5	OK	OK
SEC 256M (M368L3223DTM-CC4) K4H560838D-TCC4	OK	OK
CORSAIR 256M (CMX256A-3500C2PT) XMS3502 V1.1	OK	OK
SEC 256M (Apacer) K4H560838D-TCC4	OK	OK
HYNIX 256M HY5DU56822AT-D43	OK	OK

Memory Speed/CPU FSB Support Matrix

Memory FSB	DDR266	DDR333	DDR400
200 MHz	YES	YES	NO
266 MHz	YES	YES	YES*
333 MHz	NO	YES	△
400 MHz	NO	NO	YES*

△: User may try this combination, but MSI will not guarantee its functionality.

*: To know which DDR module is compatible with the mainboard, see *Recommended DDR400 Modules*.