14" CDU 1431 COLOUR MONITOR UNIT

There are three CDU 1431 units available, manufactured by:

1

- **SALORA** (Label on rear SA31)
- **MATSUSHITA** (Label on rear MA41)
- **HANTAREX** (Label on rear HA21).

These models have identical external structures, but differ in their internal architecture and the adjustments. To reach the adjusting points remove the outer casing.

CHARACTERISTICS

Colour analogous video, compatible VGA

- Screen dimensions: 14"
Horizontal dimensions: 240 mm +/- 4 mm
Vertical dimensions : 180 mm +/- 4 mm
- Input voltage: 220 V: 170 - 264 V a.c.
Network frequency: 50 Hz: 47 - 63 Hz
Degauss: At switch-on
- Horizontal synchronism:
Frequency: 31.469 KHz
Polarity: Negative or positive
Level: TTL
- Vertical synchronism:
Frequency: 50 - 70 Hz
Polarity: Negative or positive
Level: TTL
- Input signals:
Video: R, G, B control (Red, Green, Blue)
Signal: In linear voltage steps (63 steps of 11 mV)
Level: 0 - 700 mV
Polarity: Positive
- Visualized resolutions: 640 x 350 lines by columns
640 x 400 lines by columns
640 x 480 lines by columns
- External checks: Brightness
Contrast

REMOVING CASING AND DISASSEMBLY

1. Disconnect the power supply cable.
2. Remove the two fixing screws on the rear of the monitor, then remove the casing.

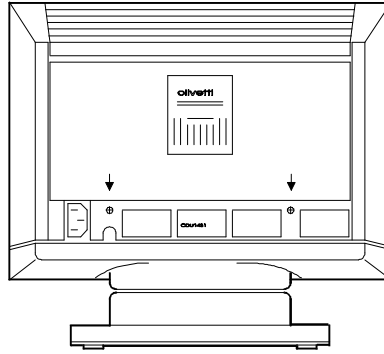

Fig. 1-1 Removing the casing on all models

3. For **SALORA VIDEO UNIT**, take out the eight fixing screws from the metal protection screen and remove it.

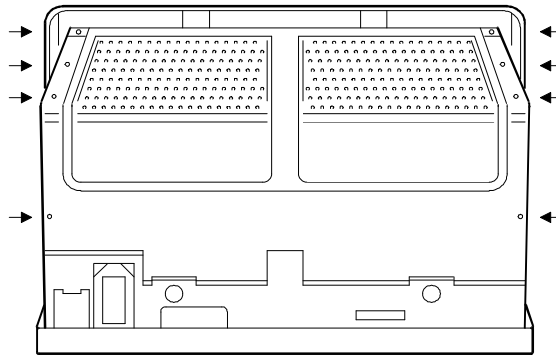

Fig. 1-2 Removing the **SALORA VIDEO** metal screen

4. For **MATSUSHITA VIDEO UNIT**, loosen the six fixing screws of the metal protection screen and remove it.

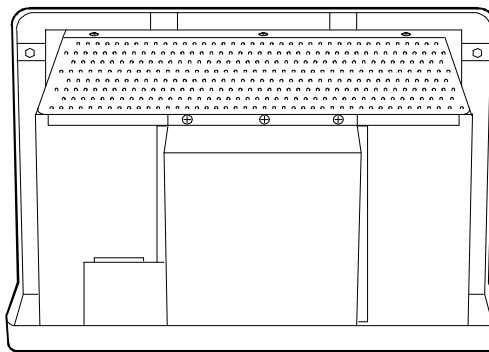

Fig. 1-3 Removing **MATSUSHITA VIDEO** metal screen

5. For **HANTAREX VIDEO UNIT**, loosen the eight fixing screws of the metal protection screen and remove it.

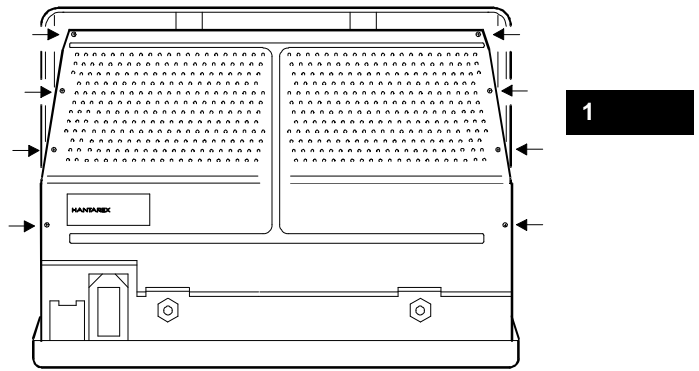

Fig. 1-4 Removing the **HANTAREX VIDEO** metal screen

6. To have access to the trimmer to adjust the vertical centering on the SALORA video unit, the screen must be removed from its base.
7. Loosen the 4 screws (two per side) that fix the screen to the monitor casing and lift it.

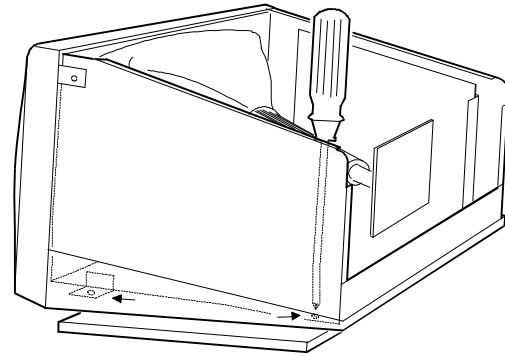

Fig. 1-5 Removing the video screen only for SALORA model

ADJUSTING THE MONITOR

Connect the power supply cable and warm up the monitor before starting to adjust.
The adjusting procedures differ according to the type of video unit.

SALORA

ADJUSTING THE HORIZONTAL RASTER

- System Test: *CROSS HATCH WITH CIRCLE AT CENTER OF SCREEN.*
- Use trimmer RTB205 to horizontally centre the picture on the screen.

ADJUSTING THE RASTER

- System Test: *HIGH INTENSITY GREY FIELD.*
- Increase the brightness with the external command until the raster area can be seen.
- Adjust trimmer RTB107 to centre the raster area.

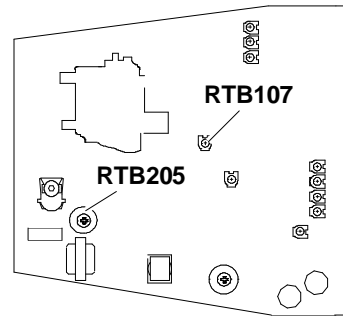

Fig. 1-6 - Horizontal raster adjustment.
- Raster adjustment

ADJUSTING THE HORIZONTAL WIDTH

- System Test: *640 BY 480 GRAPHICS.*
- Adjust RTB103 to obtain a horizontal width of 240 mm.

ADJUSTING THE HORIZONTAL LINEARITY

- System Test: *CHECK LINEARITY.*
- Adjust coil LB6 to obtain a character width as shown in the figure.

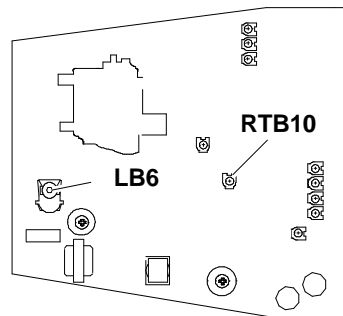
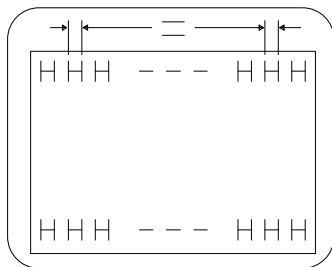

Fig. 1-7 - Horizontal width adjustment
- Horizontal linearity adjustment



NOTE: The vertical linearity and width are interactive, so the adjustment must be alternated until they are both correct.

ADJUSTING THE GEOMETRIC DISTORTION

- System Test: *CROSS HATCH WITH CIRCLE AT CENTER OF SCREEN.*
- Adjust trimmer RTB204 to make the picture as rectangular as possible.

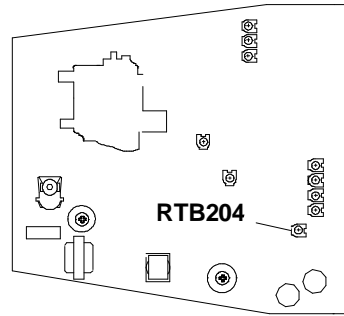

1

Fig. 1-8 Geometric distortion adjustment

ADJUSTING THE VERTICAL HEIGHT (350/400/480 LINES)

- System Test: *640 BY 350 GRAPHICS.*
- Adjust trimmer RTB109 to obtain a picture with a height of 180 mm.
- System Test: *640 BY 400 GRAPHICS.*
- Adjust trimmer RTB110 to obtain a picture with a height of 180 mm.
- System Test: *640 BY 480 GRAPHICS.*
- Adjust trimmer RTB111 to obtain a picture with a height of 180 mm.

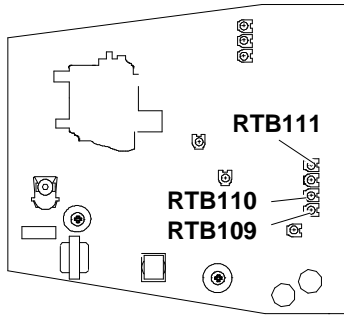

Fig. 1-9 350/400/480 lines vertical height adjustment

ADJUSTING THE VERTICAL CENTERING

To have access to the trimmer for vertical centering adjustment, the screen must be removed from its base. (See monitor disassembly on the previous pages)

- System Test: *CROSS HATCH WITH CIRCLE AT CENTER OF SCREEN.*
- Use trimmer RTB101 to vertically centre the picture on the screen.

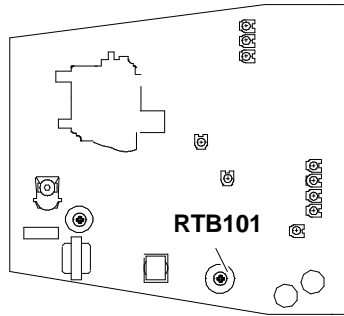

Fig. 1-10 Vertical centering adjustment

MATSUSHITA

The adjustment points for the Matsushita monitor are on two boards: one is the motherboard situated horizontally on the upper part of the monitor, the other is the interface board that is mounted vertically on the left-hand side.

ADJUSTING THE HORIZONTAL SHIFT

- System Test: *CROSS HATCH WITH CIRCLE AT CENTER OF SCREEN.*
- Adjust trimmer VR501A on the motherboard to horizontally centre the picture on the screen.

ADJUSTING THE VERTICAL CENTERING

- System Test: *CROSS HATCH WITH CIRCLE AT CENTER OF SCREEN.*
- Adjust trimmer VR431 on the motherboard until the picture is centred vertically on the screen.

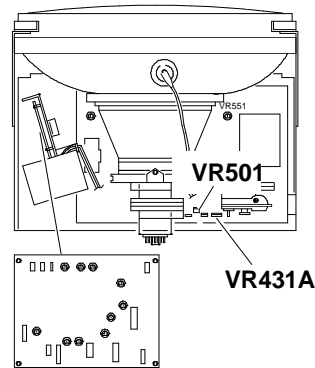

Fig. 1-11 - Horizontal shift adjustment
- Vertical centering

ADJUSTING THE GEOMETRIC DISTORTION

- System Test: *CROSS HATCH WITH CIRCLE AT CENTER OF SCREEN.*
- Adjust trimmer VR751 on the interface board to make the picture as rectangular as possible.

ADJUSTING THE HORIZONTAL HEIGHT

- System Test: *640 BY 480 GRAPHICS.*
- Adjust trimmer VR511 on the motherboard to obtain a picture with a width of 240 mm.

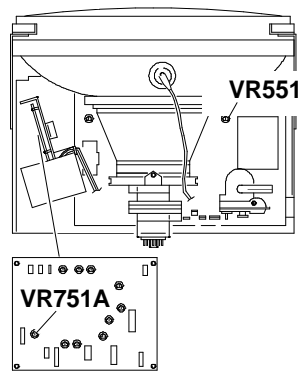

Fig. 1-12 Geometric distortion adjustment

ADJUSTING THE VERTICAL HEIGHT (350/400/480 LINES)

- System Test: *640 BY 350 GRAPHICS.*
- Adjust trimmer VR201 on the interface board to obtain a picture with a height of 180 mm.
- System Test: *640 BY 400 GRAPHICS.*
- Adjust trimmer VR202 on the interface board to obtain a picture with a height of 180 mm.
- System Test: *640 BY 480 GRAPHICS.*
- Adjust trimmer VR420A on the motherboard to obtain a picture with a height of 180 mm.

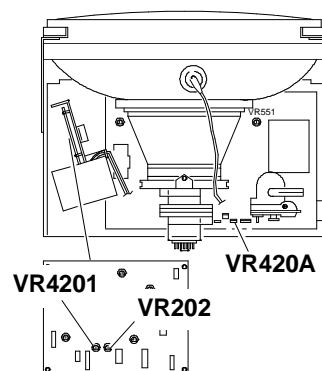

Fig. 1-13 350/400/480 lines vertical height adjustment

HANTAREX

All the adjustment points are on the motherboard which is mounted horizontally on the base of the monitor.

1

ADJUSTING THE HORIZONTAL RASTER CENTERING

- System Test: *HIGH INTENSITY GREY FIELD*.
- Increase the brightness with the external command until the surrounding area can be seen.
- Use trimmer RV2 to centre the surrounding area on the screen as shown in the figure.

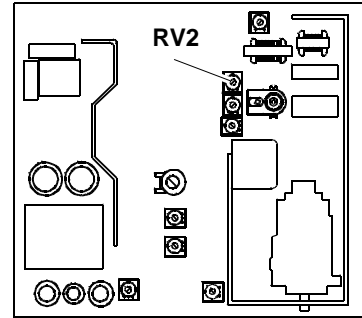

Fig. 1-14 Horizontal raster centering adjustment

ADJUSTING THE HORIZONTAL LINEARITY

- System Test: *CHECK LINEARITY*.
- Adjust inductance B1 to have the characters uniform as shown.

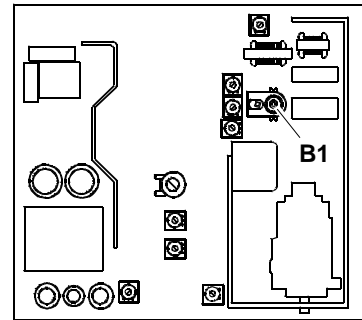
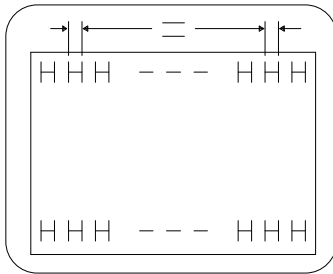

Fig. 1-15 Horizontal linearity adjustment

ADJUSTING THE HORIZONTAL WIDTH

- System Test: *640 BY 480 GRAPHICS*.
- Adjust trimmer RV10 to obtain a picture with a width of 240 mm.

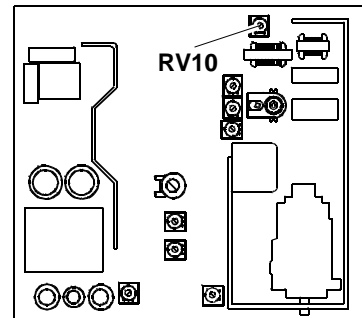

Fig. 1-16 Horizontal width adjustment

NOTE: The vertical linearity and width are interactive adjustments, therefore alternate the adjustment until both are correct.

ADJUSTING THE GEOMETRIC DISTORTION

- System Test: *CROSS HATCH WITH CIRCLE AT CENTER OF SCREEN.*
- Adjust trimmer RV9 to make the picture as rectangular as possible.

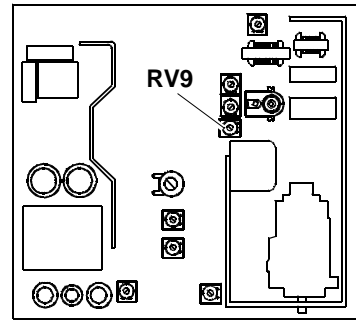

Fig. 1-17 Geometric distortion adjustment

ADJUSTING THE VERTICAL LINEARITY

- System Test: *CHECK LINEARITY.*
- Adjust trimmer RV6 to obtain the character height illustrated.

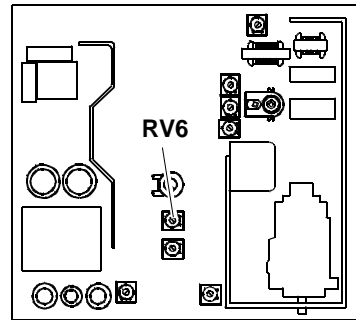
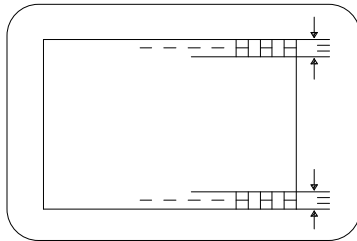

Fig. 1-18 Vertical linearity adjustment

ADJUSTING THE VERTICAL HEIGHT (350/400/480 LINES)

- System Test: *640 BY 350 GRAPHICS.*
- Adjust trimmer RV3 to obtain a picture with a height of 180 mm.
- System Test: *640 BY 400 GRAPHICS.*
- Adjust trimmer RV4 to obtain a picture with a height of 180 mm.
- System Test: *640 BY 480 GRAPHICS.*
- Adjust trimmer RV5 to obtain a picture with a height of 180 mm.

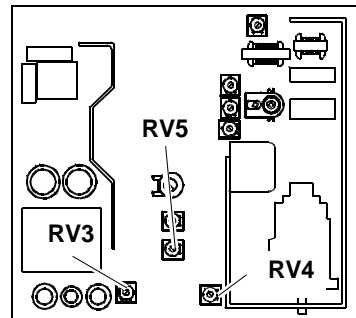

Fig. 1-19 350/400/480 lines vertical height adjustment

NOTE: The vertical linearity and width are interactive adjustments, they should be adjusted alternately until both are correct.