

Pocket Ethernet  
Adapter III

---

User's  
Guide

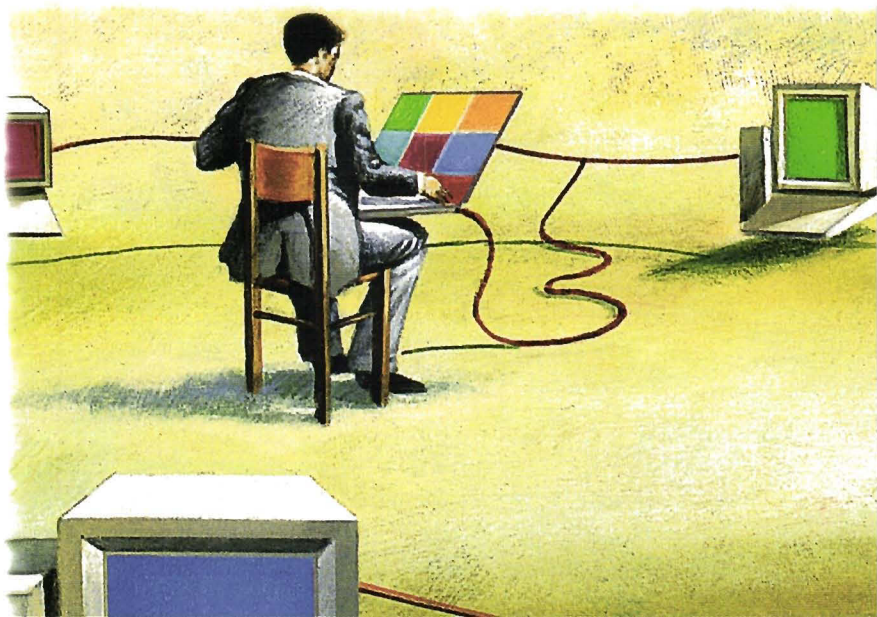



# POCKET ETHERNET ADAPTER III

## USER'S GUIDE

### **XIRCOM CORPORATE**

2300 Corporate Center Drive (805) 376-9300  
Thousand Oaks, California 91320-1420 (805) 376-9311 FAX

### **XIRCOM EUROPE NV**

King Square, De Villermontstraat 16 +32/(0)3 450.08.11  
2550 Kontich, Belgium +32/(0)3 450.09.90 FAX

### **XIRCOM ASIA PACIFIC LTD**

#13-03 Cecil Court +65 323 1511  
138 Cecil Street +65 224 3313 FAX  
Singapore 069538

November 1995

Xircom reserves the right to make improvements and/or changes in the products and programs described in this User's Guide at any time without notice.

The software described in this User's Guide is furnished under a license and may be used or copied only in accordance with such license.

©1995 Xircom, Inc. All rights reserved. Neither this publication nor any part of this publication may be copied, photocopied, reproduced, translated or reduced to any electronic medium or machine readable form without the prior written permission of Xircom.

Xircom is a registered trademark and Pocket Ethernet Adapter III is a trademark of Xircom, Inc.

All other product, brand, or trade names used in this publication are the property of their respective trademark holders.

# CONTENTS

<b>INTRODUCTION</b> .....	1
Model Numbers .....	2
Software .....	2
Local Parallel Printer Access .....	3
Specifications .....	4
Power .....	6
<b>HARDWARE INSTALLATION</b> .....	<b>9</b>
Unpacking and Inspection .....	9
Package Contents .....	9
Other Required Equipment .....	10
Pocket Ethernet Adapter III Installation .....	11
Installation of Model PE3-1OB2 (Thin Ethernet) .....	11
Installation of Model PE3-1OBT (Twisted Pair) .....	12
Installation of Model PE3-1OBC (Combination) .....	12
Installation of Model PE3-1OBX (Thick Ethernet) .....	13
Connecting the Pocket Adapter to the Computer .....	14
Parallel Port Performance .....	15
Connecting Power .....	16
Installing the Phantom Power Cable .....	17
<b>CONFIGURATION AND DIAGNOSTICS</b> .....	<b>19</b>
Diagnostic Indicator Lights .....	19
Enhanced Parallel Port Utility .....	22
Diagnostic Self Test .....	24
Executing the Self Test .....	24

<b>SOFTWARE SETUP AND OPERATION .....</b>	<b>27</b>
Artisoft LANtastic .....	27
AT&T/NCR StarGROUP LAN Manager .....	28
Banyan VINES .....	30
DEC PATHWORKS .....	31
FTP Software LANWatch .....	34
FTP Software PC/TCP .....	36
HP LAN Manager .....	40
IBM OS/2 (version 2.0) Extended Services .....	41
IBM OS/2 LAN Server .....	42
IBM OS/2 Extended Edition .....	44
Microsoft LAN Manager .....	46
Microsoft Windows 95 .....	47
Microsoft Windows for Workgroups .....	49
Microsoft Windows NT .....	53
Novell NetWare .....	55
Novell NetWare 3.1x and 4.x Server Driver .....	57
Novell Personal NetWare .....	61
SunSelect PC-NFS .....	62
Ungermann-Bass Net/One LAN Manager .....	63
Wollongong PathWay Access .....	65
<b>APPENDIX A. ERROR MESSAGES .....</b>	<b>67</b>
<b>APPENDIX B. SOFTWARE SUPPLIED .....</b>	<b>69</b>
<b>APPENDIX C. COMMAND LINE PARAMETERS .....</b>	<b>73</b>
<b>APPENDIX D. 24-HOUR GLOBAL SUPPORT SERVICES .....</b>	<b>81</b>
<b>APPENDIX E. LIFETIME LIMITED WARRANTY .....</b>	<b>85</b>
<b>APPENDIX F. SOFTWARE LICENSE AGREEMENT .....</b>	<b>89</b>
<b>APPENDIX G. REGULATORY AGENCY NOTICES .....</b>	<b>91</b>
<b>INDEX .....</b>	<b>93</b>

# INTRODUCTION

The Xircom Pocket Ethernet Adapter III, shown in Figure 1, allows you to connect a personal computer to an Ethernet local area network (LAN). The Adapter connects externally to a standard parallel printer port on a portable or desktop computer.

Xircom Adapters are ideal for mobile computer users who need a flexible LAN connectivity solution. Xircom Adapters contain no configuration switches, and are not subject to the address and interrupt conflicts common with internal adapters.

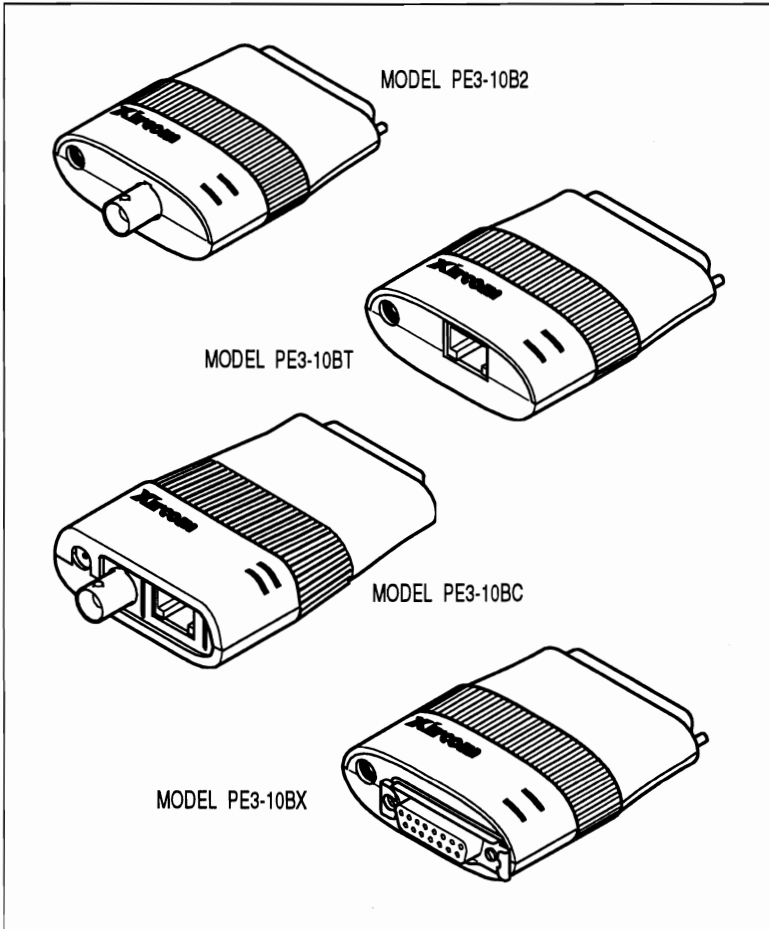

Figure 1. Xircom Pocket Ethernet Adapter III

## MODEL NUMBERS



### **Model PE3-10B2**

10BASE-2 thin coax with  
BNC connector

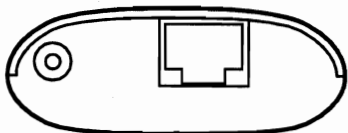

### **Model PE3-10BT**

10BASE-T and StarLAN 10  
unshielded twisted pair with  
an RJ-45 connector

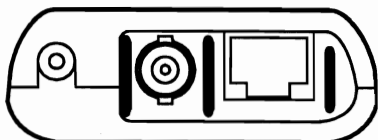

### **Model PE3-10BC**

Combination unit supporting  
both unshielded twisted pair  
(RJ-45 connector) and thin  
coax (BNC connector)

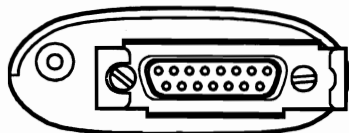

### **Model PE3-10BX**

10BASE-5 thick Ethernet using  
AUI cable with a 15-pin D  
connector

## SOFTWARE

Drivers and diagnostic programs are supplied on a 3.5-inch diskette. NDIS, ODI (Novell NetWare), and packet drivers are included. See Appendix B for a complete list of files and subdirectories.

AT&T StarLAN 10 is supported on Models PE3-10BT and PE3-10BC by disabling link integrity. See Appendix C.

Contact Xircom for information regarding the use of Xircom's Pocket Ethernet Adapter III in other networking environments.

## LOCAL PARALLEL PRINTER ACCESS

The Xircom Parallel Port Multiplexor (available as a separate product) can be used with the Pocket Ethernet Adapter III to provide simultaneous access to the LAN and a local parallel printer. Software support for the Parallel Port Multiplexor is programmed into the DOS drivers provided on the Xircom Network Drivers diskette.

### Note

**DO NOT USE** the device drivers **PPX.COM** or **PPX.SYS** supplied with the Parallel Port Multiplexor with the Pocket Ethernet Adapter III network drivers. Remove any references to **PPX.COM** or **PPX.SYS** from any **\*.BAT** or **CONFIG.SYS** files on your system. The new Pocket Ethernet Adapter III driver will automatically determine which **PPX** port (A or B) is configured for the Xircom Pocket Adapter and which one for the printer. **A PRINTER ATTACHED THROUGH THE PPX MUST BE POWERED ON FOR THE DRIVER TO LOAD.**

The **PPX** cannot be used with the **NDIS 3.0** driver under Microsoft Windows for Workgroups or Windows NT or with **OS/2** drivers.

Some machines that support Enhanced Parallel Port (**EPP**) capability may not operate in **EPP** when used in conjunction with a **PPX**.



## SPECIFICATIONS

### Media Interface Specifications By Model

#### **Model PE3-10B2**

For thin Ethernet and IEEE 802.3 (10BASE-2) with BNC connector. BNC "T" connector also supplied.

#### **Model PE3-10BT**

For IEEE 802.3 (10BASE-T) and StarLAN 10 twisted pair Ethernet with RJ-45 connector.

#### **Model PE3-10BC Combination**

For IEEE 802.3 (10BASE-T) twisted pair Ethernet and StarLAN 10 with RJ-45 connector and for thin Ethernet and IEEE 802.3 (10BASE-2) with BNC connector ("T" connector supplied).

#### **Model PE3-10BX**

For IEEE 802.3 (10BASE-5) thick Ethernet using an AUI cable with a 15-pin D-type connector.

## Additional Specifications

### Size:

**Models PE3-10BT, PE3-10B2,  
and PE3-10BX** 3.22 in x 2.27 in x 0.81 in  
(81.8 mm x 57.7 mm x  
20.6 mm) overall, includ-  
ing connector

**Model PE3-10BC** 4.19 in x 2.38 in x 0.97 in  
(107 mm x 61 mm x  
25 mm) overall, including  
connector

### Weight:

**Models PE3-10BT, PE3-10B2,  
and PE3-10BX** 2.2 oz (62 g)

**Model PE3-10BC** 2.9 oz (82.2 g)

**Operating Temperature Range:** 32°F to 122°F  
(0°C to 50°C)

**Storage Temperature Range:** -40°F to 176°F  
(-40°C to 80°C)

**Memory Size:** 32K x 8 network buffer  
256-bit EEPROM  
configuration storage

**Transfer Rate:** 10 megabits per second

**Diagnostics:** Self test capability

**FCC Certification:** Part 15, Subpart J, Class A

## POWER

### Phantom Power Cable

The Phantom Power Cable supplied with the Pocket Ethernet Adapter III allows you to power all Adapter models (except PE3-10BX) directly from a PS/2-style (6-pin mini-DIN) mouse port on your computer. The cable includes a pass-through connector that allows a **mouse** to be plugged in on top of the Phantom Power Cable connection. The coiled cable is extensible to a length of 33 inches (0.84 m). See the *Hardware Installation* section for details.

#### Cautions

- (1) **TURN OFF COMPUTER POWER** before connecting or disconnecting the Phantom Power Cable.
- (2) The Phantom Power Cable pass-through connector should be used **ONLY WITH A MOUSE**.
- (3) The Phantom Power Cable can be used only with Adapter models PE3-10B2, PE3-10BT, and PE3-10BC. Model PE3-10BX requires that an external wall-mount AC adapter be used.
- (4) The PS/2-style 6-pin port on IBM L40SX and Canon NoteJet computers **IS NOT COMPATIBLE** with the Xircom Phantom Power Cable. Use the Xircom wall-mount AC adapter with these machines.

## Wall-Mount AC Power Adapter

AC power adapter specifications are listed below for the U.S.A. and Canada (approved models are also available for the U.K., Europe, Japan, Australia/New Zealand, Korea, and the Philippines):

<b>Input Voltage:</b>	120 VAC/60 Hz
<b>Output Voltage:</b>	12 VDC unregulated, 300 mA (500 mA for Model PE3-10BX)
<b>Polarity:</b>	
<b>Size:</b>	2.76 in x 1.98 in x 1.59 in (70.1 mm x 50.3 mm x 40.4 mm) overall including connector and cord exit
<b>Cord Length:</b>	6 ft (1.8 m)
<b>Weight:</b>	10 oz (284 g)

### Note

Please see the Xircom Lifetime Limited Warranty under "Limitations" (Appendix E in this User's Guide) for the terms of Xircom's power supply warranty coverage.



# HARDWARE INSTALLATION

Follow the instructions in this section to unpack and install the Xircom Pocket Ethernet Adapter III hardware. Also included in this section is a discussion of parallel port performance issues, including bidirectional/non-bidirectional and Enhanced Parallel Port (EPP) modes of operation.

## UNPACKING AND INSPECTION

After opening the Pocket Ethernet Adapter III box, remove the contents and make certain that all parts are included and that none has been damaged during transportation. Retain the packing materials in case you have to return the unit for service.

## PACKAGE CONTENTS

Use this as a checklist of the contents of the package.

- Xircom Pocket Ethernet Adapter III (Model PE3-10BT, PE3-10B2, PE3-10BC, or PE3-10BX)
- AC wall-mount power adapter
- Phantom Power Cable (Models PE3-10B2, PE3-10BT, and PE3-10BC only)
- BNC T connector (Models PE3-10B2 and PE3-10BC only)
- Xircom Pocket Ethernet Adapter III User's Guide
- Product Registration Card
- 3.5-inch Network Drivers diskette.

### Note

Please fill out the Product Registration Card supplied with the Adapter and return it immediately.

## OTHER REQUIRED EQUIPMENT

To install the Pocket Ethernet Adapter III, you need the following:

1. A supported local area network operating system. See the section on *Software Setup and Operation* for information about networks for which Xircom supplies drivers.
2. For connection to a 10BASE-2 thin Ethernet cable, a BNC T connector (supplied); if the T connection is at the end of a cable segment, you will also need a 50-ohm terminator (not supplied).
3. For connection to a 10BASE-T twisted pair Ethernet cable, a dual twisted pair cable terminated with RJ-45 modular jacks (AT&T or D8W, or similar).
4. For connection to a 10BASE-5 thick Ethernet network, an appropriate transceiver and transceiver cable.

# POCKET ETHERNET ADAPTER III INSTALLATION

## Cautions

Before installing a Pocket Ethernet Adapter III, be sure all attached computer and printer equipment is powered OFF and that no power is being applied to the Pocket Ethernet Adapter III from any source.

Be sure computer power is OFF whenever connecting or disconnecting the Phantom Power Cable.

To prevent the possibility of damage to internal components from static electricity, do not touch or handle the gold connector pins on the parallel port connector of your Pocket Ethernet Adapter III.

## Installation of Model PE3-10B2 (Thin Ethernet)

1. Attach the T connector (and thin Ethernet network cabling) to the BNC connector on the Pocket Ethernet Adapter III as shown in Figure 2. If the Adapter is located at the end of a cable segment, attach a 50-ohm terminator to the open end of the T connector, as shown in Figure 2.

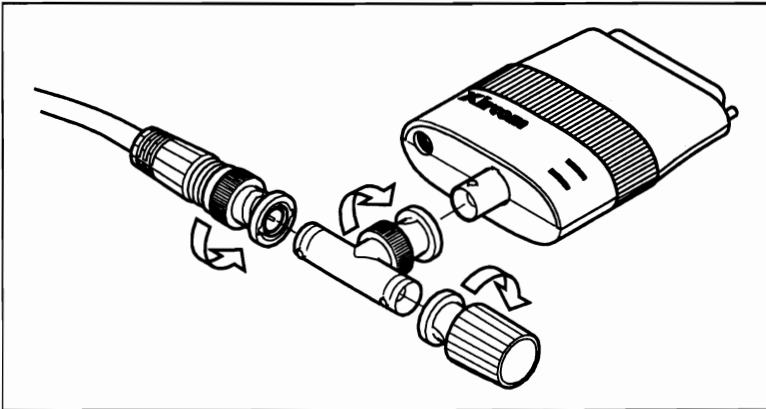

Figure 2. Attaching the Thin Ethernet Cable to Model PE3-10B2 (end of network segment)



### Note

For the network to function properly, both ends of the T connector must be attached to network cabling or, if the Adapter is at the end of a network segment, the end of the T connector not attached to the network must have a 50-ohm terminator installed.

### Installation of Model PE3-10BT (Twisted Pair)

1. Plug one end of the modular data cable into the mating connector on the Pocket Ethernet Adapter III, as shown in Figure 3.
2. Plug the other end of the modular data cable into a network access port (usually a wall connection).

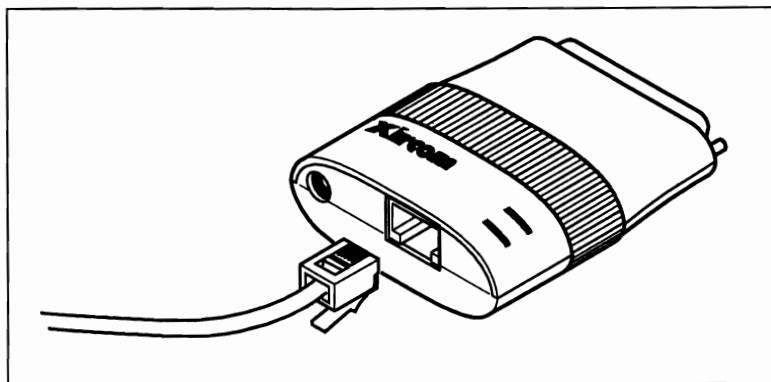

Figure 3. Attaching Twisted Pair Cabling to Model PE3-10BT

### Installation of Model PE3-10BC (Combination)

- Follow the installation instructions for Model PE3-10B2 if you are connecting to a thin Ethernet network (see Figure 2), or the instructions for Model PE3-10BT for connection to a 10BASE-T network (see Figure 3).

### Note

Only one type of Ethernet connection may be used on the Model PE3-10BC at a time: either thin Ethernet (BNC connector) or twisted pair Ethernet (RJ-45 connector), but not both.

## Installation of Model PE3-10BX (Thick Ethernet)

### Caution

Model PE3-10BX *cannot use the Phantom Power cable* supplied with other Pocket Ethernet Adapter III models.

1. Connect the 15-pin male end of the AUI cable to the female AUI connector on the Adapter. Use the "D" shape of the plug to help you attach the cable properly. Press the slide latch to the left to lock the connector in place. See Figure 4.
2. Attach the other end of the AUI cable in series with the existing network cabling. Exact methods may vary; however, they must be consistent with the other node installations on your network.
3. Connect the Adapter to the parallel port of the computer using the 25-pin D-type connector at the end of the Adapter opposite the network connector. See Figure 4.

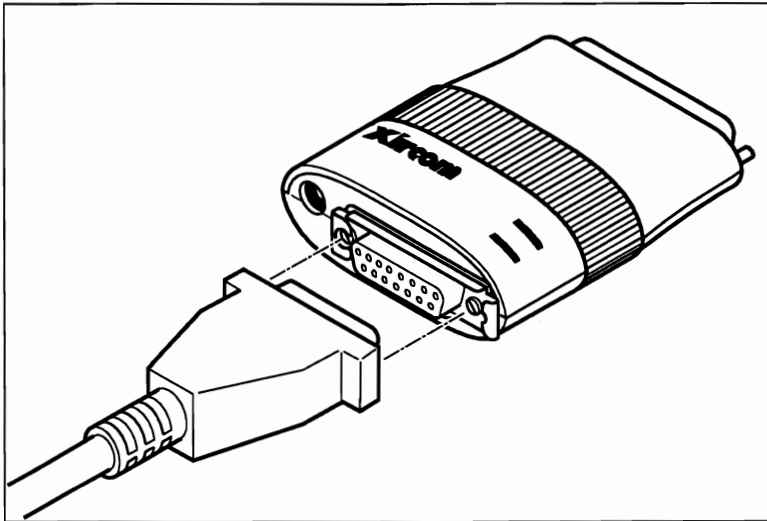

Figure 4. Attaching the AUI cable to Model PE3-10BX

## CONNECTING THE POCKET ADAPTER TO THE COMPUTER

### Caution

When attaching the Pocket Ethernet Adapter III to the parallel port of the computer, be sure that all computer and printer equipment is powered OFF and that no AC power is being applied to the Adapter. Do not touch the gold connector pins.

1. Verify that the computer is turned OFF and no power cord is connected before attaching the Pocket Ethernet Adapter III.
2. Plug the 25-pin male D-type connector on the Pocket Ethernet Adapter III into the parallel port on the back of your computer, holding the Adapter with the Xircom logo and indicator lights on the top. The two parallel port attachment screws on the Adapter align with the holes on each side of the parallel port connector.
3. Rotate the red band ("tractor grip") on the Adapter clockwise until the screws are firmly secured. Refer to Figure 5. When the screws are tight, the red band will "click" as you rotate it. (To unscrew the screws, rotate the band counterclockwise.)

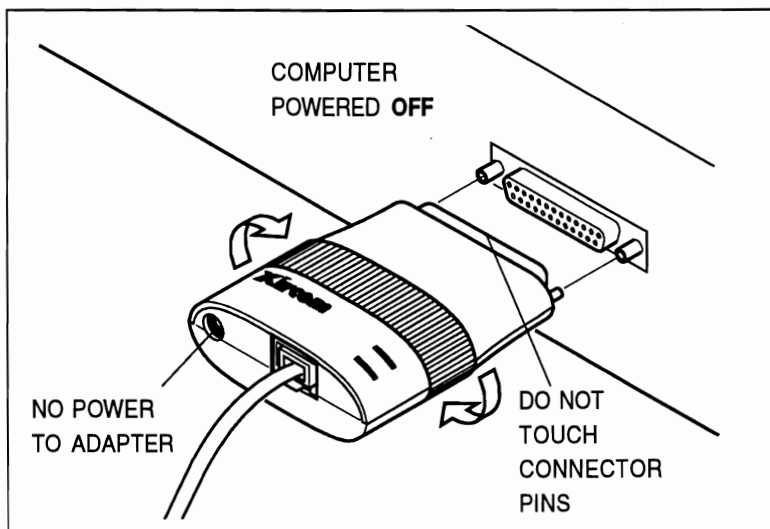

Figure 5. Connecting the Adapter to the Parallel Port on the Computer

## PARALLEL PORT PERFORMANCE

The type of parallel port on your computer can significantly affect the performance of the Pocket Ethernet Adapter III. If your PC's parallel port supports bidirectional mode, you can expect an improvement of up to 50% in the input transfer rate over a standard non-bidirectional parallel port. If your computer supports *Enhanced Parallel Port* (EPP) technology, data will be transmitted through the Adapter at three to four times the rate of a standard parallel port. All Pocket Ethernet Adapter III models are compatible with Enhanced Parallel Port technology, including EPP BIOS, and Xircom drivers will automatically configure for the fastest mode supported by your computer.

A utility program is supplied with the Pocket Ethernet Adapter III to assist with management of EPP mode on some machines. See the *Configuration and Diagnostics* section for detailed instructions on its use.

Some PC designs allow the parallel printer port to be switched between bidirectional and non-bidirectional modes of operation, while others support only one mode. To find out if your parallel port is switchable, or if it is EPP-compliant, refer to the user documentation for your computer or contact the computer manufacturer.

## CONNECTING POWER

### Caution

Before installing an AC power adapter or cable, be sure that all attached computer and printer equipment is powered OFF and that the Pocket Ethernet Adapter III is securely attached to the parallel port of the computer.

### Installing the Wall-Mount AC Power Adapter

1. Verify that the computer to which the Pocket Ethernet Adapter III is attached is powered OFF and that the wall-mount power supply is NOT plugged in to an AC outlet.
2. Plug the L-shaped end of the AC power adapter cable into the small round socket on the Pocket Ethernet Adapter III to the left of the network connector. See Figure 6.
3. Plug the AC power adapter into a standard electrical outlet.

On Models PE3-10B2, PE3-10BT, and PE3-10BX the LED indicator closest to the red tractor band will illuminate when power is applied to the Adapter and the computer to which it is connected. On Model PE3-10BC, the triangle over the letter "i" in the word Xircom will illuminate.

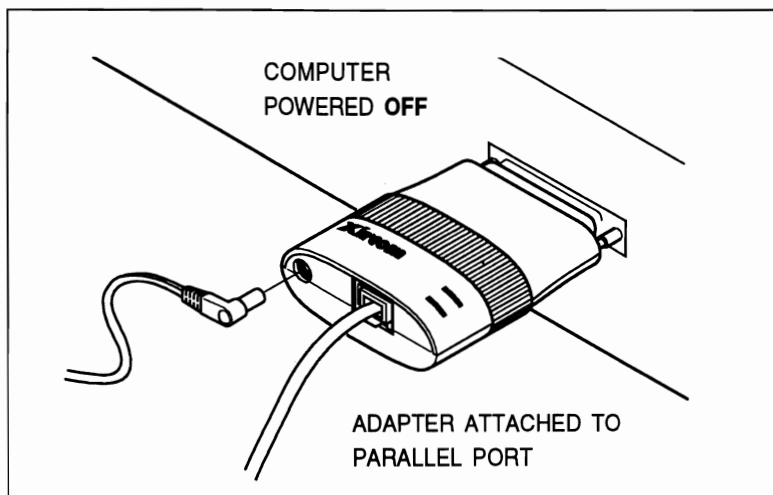

Figure 6. Plugging the Power Cable into the Pocket Ethernet Adapter III

## Installing the Phantom Power Cable

### **Cautions**

To reduce the possibility of damage due to shorting, always connect and disconnect the Phantom Power Cable with the computer powered OFF and the Pocket Ethernet Adapter III securely attached to the parallel port of the computer.

The Phantom Power Cable pass-through connector is designed for use with a MOUSE ONLY. Other devices may exceed the power rating of the CPU fuse.

The PS/2-style 6-pin mouse/keyboard connector on IBM L40SX and Canon NoteJet computers IS NOT COMPATIBLE with the Xircom Phantom Power Cable. Use of the Phantom Power Cable on these machines could damage the computer. Use the wall-mount AC adapter supplied with the product.

The Phantom Power Cable supplied with the Pocket Ethernet Adapter III is designed to work with Models PE3-10B2, PE3-10BT, and PE3-10BC only. Do not attempt to use this cable with Model PE3-10BX or other pocket adapters.

1. Verify that the computer to which the Pocket Ethernet Adapter III is attached is powered OFF and that the Adapter is securely attached to the parallel port of the computer.
2. Plug the L-shaped plug on the Phantom Power Cable into the small round socket on the Pocket Ethernet Adapter III to the left of the network connector. See Figure 6.
3. Plug other end of the Phantom Power Cable into the 6-pin PS/2-style mouse port on the computer. See Figure 7.

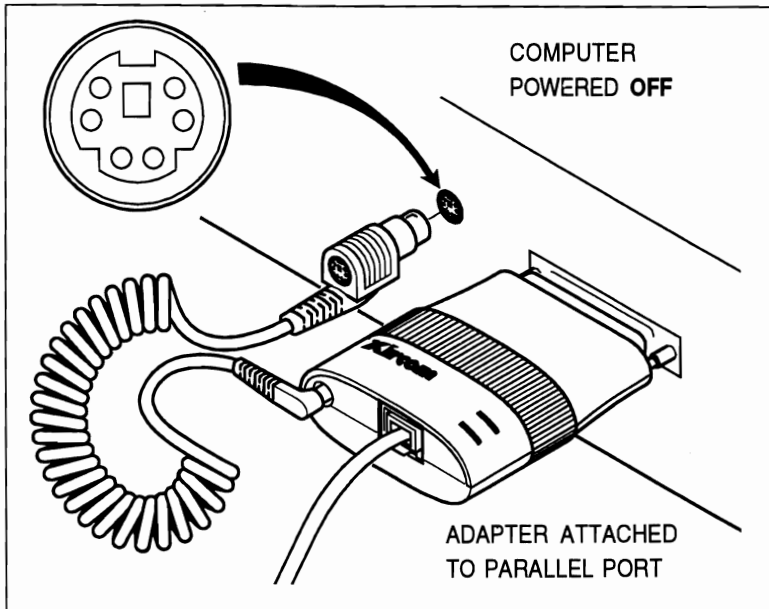

Figure 7. Connecting the Phantom Power Cable to the Computer

4. Plug a mouse cable, if required, into the duplicate mouse connector on the phantom power connector.

When power is applied to the computer to which the Pocket Ethernet Adapter III and Phantom Power Cable are connected, the LED indicator closest to the red tractor band will illuminate on Models PE3-10B2 and PE3-10BT. On Model PE3-10BC, the triangle over the letter "i" in the word Xircom will illuminate.

### **Power Management**

Do not use power management or power saver features on your computer when logged in to a network through the Pocket Ethernet Adapter III. Reduction or loss of power to the Adapter could affect the network connection.

# CONFIGURATION AND DIAGNOSTICS

This section contains a detailed description of the Pocket Ethernet Adapter III's diagnostic features: diagnostic indicator lights and PE3TEST diagnostic program. It also describes how to disable link integrity checking and reporting on Models PE3-10BT and PE3-10BC, for non-10BASE-T unshielded twisted pair networks. For additional diagnostic information, see the error messages in Appendix A.

## DIAGNOSTIC INDICATOR LIGHTS

The indicator lights on the top of the Pocket Ethernet Adapter III case function differently according to the model being used.

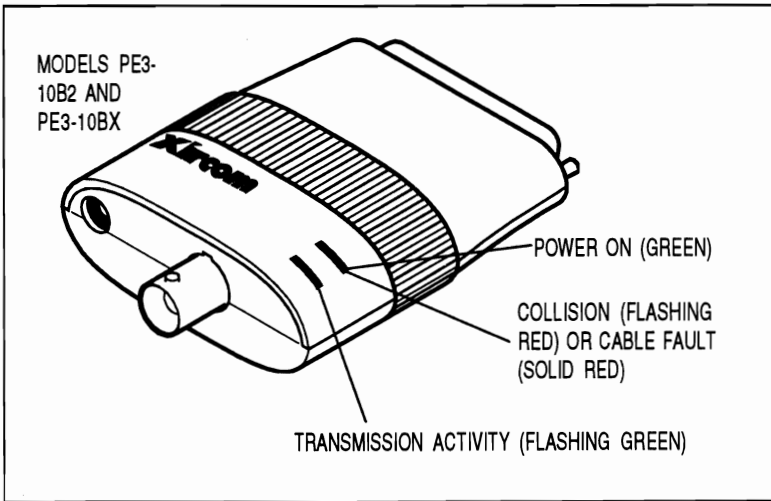

Figure 8. Pocket Ethernet Adapter III Indicator Lights for Models PE3-10B2 and PE3-10BX

### Models PE3-10B2 and PE3-10BX

The LED closest to the red band on these models displays solid green to indicate power on, flashes red to indicate a collision, and displays solid red to indicate a cable fault. The other LED indicator flashes green to show transmission activity.



## Model PE3-10BT

When the keyword LINKDISABLE is not used (default setting), the LED closest to the red band displays solid **green** when link integrity is enabled at the hub and the network driver has been loaded, and solid **orange** when hub link integrity is disabled. When LINKDISABLE is used, this LED displays solid green without reference to hub link integrity status. The other LED indicator flashes green to show transmission activity.

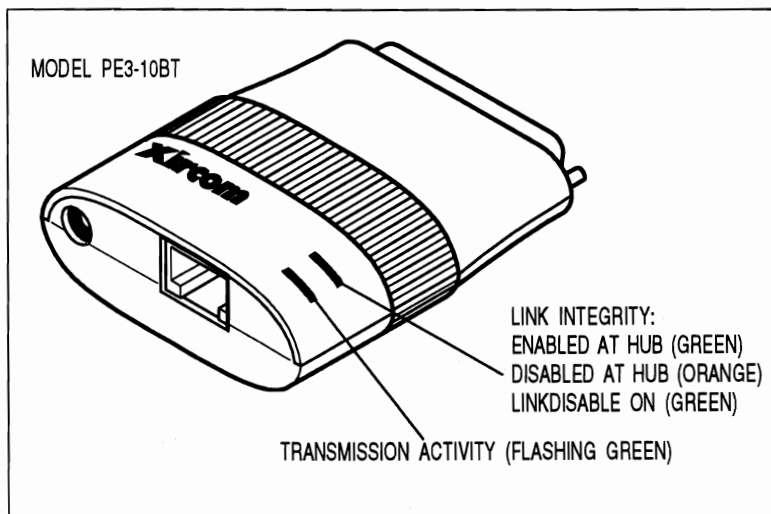

Figure 9. Pocket Ethernet Adapter III Indicator Lights for Model PE3-10BT

## Model PE3-10BC

On unshielded twisted pair networks, when the keyword LINKDISABLE is not used (default setting), the LED closest to the red band displays solid **green** when link integrity is enabled at the hub and the network driver has been loaded. It is **off** when hub link integrity is disabled or on 10BASE-2 networks. When LINKDISABLE is used, this LED displays solid green without reference to hub link integrity status.

The other LED indicator flashes green to show transmission activity, flashes red to indicate a collision, and displays solid red to indicate a cable fault. See figure 10.

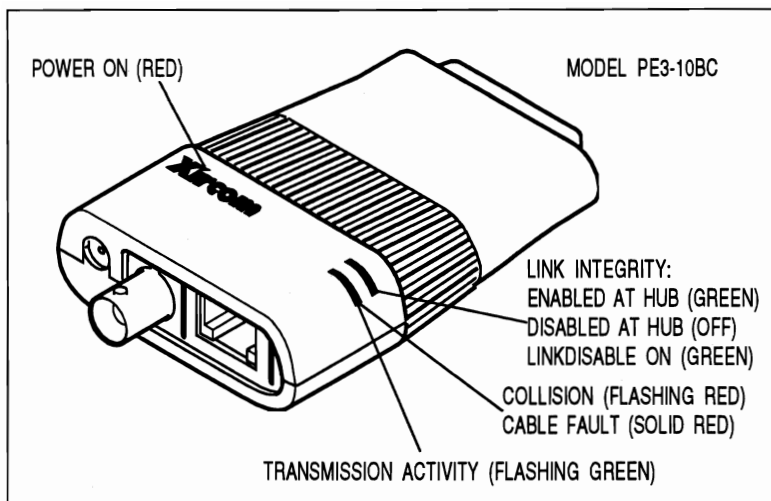

Figure 10. Pocket Ethernet Adapter III Indicator Lights for Model PE3-10BC

## How to Disable Network Link Integrity Checking and Reporting

By default, the Pocket Ethernet Adapter III enables checking and reporting of network (hub) link integrity status. This feature must be disabled for operation on non-10BASE-T unshielded twisted pair networks such as StarLAN 10. To disable link integrity checking and reporting, add the keyword

### **LINKDISABLE**

to configuration or startup files or on the command line with the driver. See *Appendix C, Command Line Parameters*, for detailed information on use of this keyword with each driver type.

### **Note**

When power is applied to both the Adapter and the computer to which it is attached, a power indicator or other LED will illuminate on all Pocket Ethernet Adapter III models. The Pocket Ethernet Adapter III shuts off when it is removed from the computer's parallel port, when its power cable is disconnected, or when the computer it is attached to is turned off.

## **ENHANCED PARALLEL PORT UTILITY**

### **EPP BIOS Support**

The Xircom drivers listed below support an EPP BIOS standard for DOS. Since the IEEE P1284.3 standard for EPP BIOS had not reached final approval at the time of this release, Xircom and numerous laptop PC manufacturers have chosen to support one of the earlier draft revisions of the standard. Specifically, this release supports draft revision 3, dated March 1993, of the EPP BIOS specification.

EPP BIOS is a standard for DOS with a PC's CPU operating in real mode. Therefore, EPP BIOS is only supported with the following DOS drivers:

- Novell ODI Workstation driver, PE3ODI.COM
- NDIS driver, PE3NDIS.EXE
- Packet driver, PE3PD.COM

### **When Do You Need the EPP Utility?**

EPP BIOS support removes the need to load a separate utility to make use of a PC's EPP capability. If EPP BIOS is present, the Xircom network drivers will detect the EPP capability of your computer, including EPP BIOS support on DOS machines (OS/2 does not provide EPP BIOS support), and configure automatically for the fastest mode.

However, on some computers you may need to run the Enhanced Parallel Port (EPP) utility to verify EPP mode or to enable EPP. Three versions of the EPP utility are provided on the Network Drivers diskette, two for DOS and one for OS/2.

If you're not sure whether your computer is EPP-capable, or supports EPP BIOS, try running the EPP utility. A message will indicate what EPP capability has been identified on your machine.

### **The NOEPP Keyword**

The ODI driver configuration file, NET.CFG, contains a keyword specifically for EPP BIOS. This keyword is "NOEPP". When this keyword is present in the NET.CFG file or the PROTOCOL.INI file, EPP mode will NOT be invoked by way of EPP BIOS.

### Note

Some machines with EPP hardware do not support EPP functionality because of their parallel port design. In these cases, the network driver will load in standard bidirectional or non-bidirectional mode. Consult your computer's documentation or manufacturer for additional information.

## Using the EPP Utility with DOS

To use EPP.COM as part of your DOS AUTOEXEC.BAT (or other \*.BAT) file:

1. Copy EPP.COM from the Xircom Network Drivers diskette to your hard disk or boot diskette.
2. Use an ASCII text editor to add the following line to your AUTOEXEC.BAT or other \*.BAT file:

**[path]EPP**

where *[path]* is the drive and directory to which you copied EPP.COM.

3. Save the modified \*.BAT file.
4. Run the \*.BAT file.

To use EPP.SYS in your DOS CONFIG.SYS file:

1. Copy EPP.SYS from the Xircom Network Drivers diskette to your hard disk or boot diskette.
2. Use an ASCII text editor to add the following line to your CONFIG.SYS file:

**DEVICE=[path]EPP.SYS**

where *[path]* is the drive and directory to which you copied EPP.SYS.

3. Save the modified CONFIG.SYS file.
4. Reboot the PC.

## Using the EPP Utility with OS/2

To use EPP.OS2 in your OS/2 CONFIG.SYS file:

1. Copy EPP.OS2 from the Xircom Network Drivers diskette to your hard disk.
2. Use an ASCII text editor to add the following line to your CONFIG.SYS file:

```
DEVICE=[path]EPP.OS2
```

where *[path]* is the drive and directory to which you copied EPP.OS2.

3. Save the modified CONFIG.SYS file.
4. Reboot the PC.

## DIAGNOSTIC SELF TEST

In addition to the diagnostic and power-on indicators described at the beginning of this section, Xircom provides a self test diagnostics program called **PE3TEST**. This program, located on the Network Drivers diskette, tests the Pocket Ethernet Adapter III configuration, setup, checksum, and memory. It also reports test results, the serial number of the unit, and the node address. PE3TEST will also report the fastest parallel port mode available on your computer.

## EXECUTING THE SELF TEST

Use the following steps to execute the self test.

1. Install the Pocket Ethernet Adapter III hardware according to the instructions contained in the *Installation and Setup* section of this User's Guide.
2. Boot your computer from DOS without loading a network driver. While a network driver **must not be loaded** for PE3TEST to run, you may have to run the EPP Utility. See the heading "Enhanced Parallel Port Utility" earlier in this section.
3. Insert the Xircom Network Drivers diskette in the diskette drive on your computer and change to that drive.

4. At the diskette drive DOS prompt run the diagnostics by typing **PE3TEST** and then pressing Enter.

### **Note**

**If an error message displays when you execute the self test, refer to *Appendix A, Error Messages*.**

The diagnostic program displays a set of windows on your computer's screen showing test parameters and results.

An explanation of the self test results follows.

### **Hardware, EEPROM, Init, and Memory Tests**

The Hardware test verifies that the Adapter is powered on and properly connected to the parallel port. The EEPROM test reads the EEPROM and verifies EEPROM data (this is where the Adapter's serial number and node address are stored). The Init test initializes the Adapter memory and Ethernet controller. The Memory test tests the 32K x 8 RAM on the Pocket Ethernet Adapter III.

A failure in any of these tests may indicate that service is required for the Pocket Ethernet Adapter III. Contact Xircom Technical Support.

### **Adapter Data**

This section displays the model number, serial number, manufacturing date of the unit, and the network node address. This data has been preprogrammed at the factory and cannot be altered.

### **Important**

**Record the Adapter model and serial numbers in a convenient location for quick reference when calling Technical Support.**

Technical Support will ask you to supply the model and serial numbers when requesting technical assistance or warranty service from Xircom.

## Configuration

This portion of the diagnostic screen describes interrupt settings, port settings, and parallel port transfer modes. Some computers allow the parallel port to be switched between bidirectional, non-bidirectional, and Enhanced Parallel Port (EPP) modes. For an optimal transfer rate, the unit should be in EPP or bidirectional mode. **PE3TEST** reports the mode of your parallel port, including Enhanced Parallel Port mode if the EPP utility EPP.COM or EPP.SYS has been run prior to testing or EPPBIOS is present.

To find out if you can switch modes on your parallel port, consult the documentation for your computer or contact the computer manufacturer.

## Transmit Test

During this test the Adapter transmits a packet addressed to itself every 1/2 second. A failure indicates that the Adapter is not accepting transmitted packets. Contact Xircom Technical Support.

## Network Traffic Graph

This graph provides a visual representation of the volume of traffic on the network. If there is no traffic (or if the Adapter is not connected to the network), a line of dots will display at the bottom of the chart.

# SOFTWARE SETUP AND OPERATION

This section provides installation information for the network drivers supplied on the Pocket Ethernet Adapter III Network Drivers diskette. It is organized in *alphabetical* order by network operating system.

Be sure you have the latest released versions of the drivers you need. These are available on the Xircom BBS and through on-line services listed in Appendix D.

These instructions are designed to take advantage of the Pocket Ethernet Adapter's self-configuring and default features. For more detailed information on the drivers, see *Appendix C, Command Line Parameters*.

## **Making a Backup Copy of the Software**

Before beginning driver installation, use DOS DISKCOPY to make a copy of the Network Drivers diskette supplied with your Pocket Ethernet Adapter III. Use the copy to install the software.

## **ARTISOFT LANTASTIC (VERSION 6.0) NDIS DRIVER**

1. Run the Artisoft LANtastic 6.0 "install" program.
2. At the "Select network adapter" screen, choose "NDIS Support for Network Adapters."
3. When prompted for the "manufacturer's driver diskette" on the "Enter NDIS driver directory" screen, insert the Xircom Network Drivers Disk and type

**A:\NDIS**

in the Path dialog box.

4. Complete the Artisoft installation.
5. Reboot the computer and start LANtastic.

For additional installation information and sample configuration files, request **Document 3005** from the Xircom FactsLine (see Appendix D for telephone numbers).



## AT&T/NCR STARGROUP LAN MANAGER (VERSION 2.1A)

See Microsoft LAN Manager.

## AT&T/NCR STARGROUP (VERSION 3.5) LAN MANAGER (VERSION 2.0) NDIS DRIVER

1. Make working copies of the StarGROUP Client install diskette(s) using the DOS DISKCOPY program.

### Note

If installing from two 720K diskettes, make room for the Xircom files listed below by deleting some third party drivers (along with their NIF files and associated directories) from the working copy of the "Network Program & Drivers 1 and 2" diskette. Do not delete any "ATT..." subdirectories or files.

2. Copy the file XIRATT35.NIF from the \ATT35 directory of the Xircom Network Drivers diskette into the \DOS\DRIVERS2 directory of the StarGROUP Client install diskette.
3. Create a XIRATT35 directory on the StarGROUP Client install diskette as follows:

```
A: \>MD \DOS\DRIVERS2\XIRATT35
```

4. Copy the file PROTOCOL.INI from the \ATT35 directory on the Xircom Network Drivers diskette to the directory \DOS\DRIVERS2\XIRATT35 on the StarGROUP Client diskette.
5. Copy the PE3NDIS.EXE file from the \NDIS directory on the Xircom Network Drivers diskette to the directory \DOS\DRIVERS2\XIRATT35 of the StarGROUP Client install diskette.
6. You may now use the modified StarGROUP Client install diskette to install StarGROUP on the client computer. Refer to the StarGROUP documentation for further information.

## **AT&T/NCR STARGROUP (VERSIONS 3.3 AND 3.4) NDIS DRIVER**

1. Make working copies of the StarGROUP Client install diskette(s) using the DOS DISKCOPY program.
2. Copy the file XIRATT34.NIF from the \ATT34 directory of the Xircom Network Drivers diskette into the \DOS\DRIVERS directory of the StarGROUP Client install diskette.
3. Create a XIRATT34 directory on the StarGROUP Client install diskette as follows:

**A: \>MD \DOS\DRIVERS\XIRATT34**

4. Copy the PROTOCOL.INI file from the \ATT34 directory on the Xircom Network Drivers diskette to the directory \DOS\DRIVERS\XIRATT34 on the StarGROUP Client diskette.
5. Copy the PE3NDIS.EXE file from the \NDIS directory on the Xircom Network Drivers diskette to the directory \DOS\DRIVERS\XIRATT34 on the StarGROUP Client diskette.
6. You may now use the modified StarGROUP Client install diskette to install StarGROUP on the client computer. Refer to the StarGROUP documentation for further information.

## BANYAN VINES (VERSIONS 5.5) NDIS DRIVER

1. Create a Banyan directory on your workstation hard disk or VINES boot diskette. For example:

```
C:>MD \VINES
```

2. At the DOS prompt, copy the files PE3NDIS.EXE and PROTOCOL.INI from the \NDIS directory on the Xircom Network Drivers diskette to the \VINES directory just created.
3. Copy the files from the VINES Master diskette into the \VINES directory. (If you need to create a VINES workstation disk, run PCCOPY on a currently logged in workstation and copy PCCONFIG, NDIS ETHERNET, and the REDIRALL drivers to a diskette.)
4. Copy the NDIS driver files from \NDIS directory on the VINES LAN Drivers diskette into the \VINES directory.
5. Using an ASCII text editor, edit the CONFIG.SYS file to include the following lines:

```
DEVICE=C:\VINES\PROTMAN.DOS /I:C:\VINES
```

```
DEVICE=C:\VINES\PE3NDIS.EXE
```

6. Change to the \VINES directory.
7. Type PCCONFIG and select Network Card Settings, followed by NDIS Ethernet.
8. Select interrupt level 7 if your Xircom Pocket Ethernet Adapter III is using LPT1 or LPT3, or interrupt level 5 if the Adapter is using LPT2.
9. At the PROTOCOL.INI bindings prompt type XIRCOMNET.
10. Press F10 to save and Esc to return to the main menu.
11. Select Login Environment Settings, followed by Default Communications Driver, followed by NDIS Ethernet.
12. Press Esc to return to the Main Menu and press F10 to save.
13. Reboot the PC.

For additional installation information and sample configuration files, request **Document 3016** from the Xircom FactsLine (see Appendix D for telephone numbers). Refer to your Banyan VINES documentation for additional information.

## DEC PATHWORKS VERSIONS 5.X (NDIS DRIVER)

These instructions are based on PATHWORKS documentation for configuration of a PC as a client workstation, using a system service already installed on a LAN Manager server and the LAN Manager SETUP diskette.

1. Check the README file on your PATHWORKS SETUP disk for requirements such as lastdrive, setver, etc. You will need 500 K of free conventional memory and about 1 MB of extended memory to run PATHWORKS SETUP. Be sure you have a lastdrive statement in your CONFIG.SYS file (lastdrive=g will work in most cases).
2. Use a text editor to modify the file A:\NDIS\PI.TPL on the PATHWORKS SETUP disk, as follows (A:\NDIS is a hidden directory. You can access it by typing CD A:\NDIS):

Remove the semicolon at the beginning of the mi\_irq line, as follows:

Change the line

```
;ni_irq= 7
```

to read

```
ni_irq= 7
```

The **ni\_irq** value must be the same as the interrupt value you will use for the Xircom adapter.

3. Run the SETUP program from the PATHWORKS SETUP disk for LAN Manager.
4. Choose Configure PC.
5. Choose Network.
6. Select DECnet as transport.
7. When prompted to choose a network adapter, choose "Other."
8. Specify "Xircom" as the Adapter Name.

9. When prompted for driver information
  - a. for PATHWORKS 5.0, use the following information:

```
NDIS Driver Path: a:\  
NDIS Driver File: pe3ndis.exe  
NDIS Driver Name: Xircom$  
Other File: _____
```

- b. for PATHWORKS 5.1, use the following information:

```
Driver file: a:\pe3ndis.exe  
PROTOCOL.INI stub: a:\dec\protocol.ini  
Additional Files: _____
```

10. Insert the Xircom Network Drivers Disk when prompted.
11. Enter your node information when prompted.
12. Edit the PROTOCOL.INI file to read as follows:

```
drivername=xircom$
```

At this point, the SETUP program will try to connect to the DECnet server. Once connected, the SETUP program will map a logical drive to your system service.

13. Highlight the logical drive mapped by the SETUP program, and press Enter to run PWSETUP.
14. Press Enter to confirm the Software Destination C:\PW.
15. Choose Express (or Custom if you have a lot of prior installation experience).
16. Select an appropriate Workstation Template, or create one.

17. Under Network Adapter Information, choose other network adapter, with NDIS enabled, and verify the following information:

**Non-Supported Network Adapter**

**Driver file:** a:\pe3ndis.exe

**PROTOCOL.INI stub:** a:\dec\protocol.ini

**Additional Files:** \_\_\_\_\_

18. Insert the Xircom Network Drivers Disk when prompted.
19. Enter node information when prompted and proceed.
20. A PROTOCOL.INI file created by SETUP will display in edit mode.
21. Remove the semicolon at the beginning of the **ni\_irq** line, as follows:

Change the line

```
;ni_irq = 7
```

to read

```
ni_irq = 7
```

The **ni\_irq** value must be the same as the interrupt value used for the Xircom adapter.

22. Verify that the [**pe3ndis**] section has the settings specified in step 9.
23. Exit SETUP and reboot to start the network. (Some machines may require a cold boot at this point—power the computer down and back up again.)

For additional configuration information and sample configuration files, request **Document 3036** from the Xircom FactsLine (see Appendix D for telephone numbers).

## FTP SOFTWARE LANWATCH (PACKET AND NDIS DRIVERS)

FTP Software's LANWatch network monitor software (versions 2.01 or later) can be installed using Xircom's packet or NDIS drivers. For information on which driver is appropriate for your network environment, refer to the FTP LANWatch documentation.

### FTP Software LANWatch Packet Driver Installation

1. Install LANWatch according to the instructions in your FTP LANWatch manual.
2. Copy the file PE3PD.COM from the \PKTDRV directory on the Xircom Network Drivers diskette to the directory where your LANWatch files are stored.
3. (This step not required for LANWatch versions 3.0 and later.)  
Using an ASCII text editor, add the following line to your CONFIG.SYS file:

**DEVICE = [path]IFCUST.SYS**

where [path] is the drive and directory where your LANWatch files are stored.

4. Reboot the PC.
5. Change to the directory where your LANWatch files are stored and run PE3PD.COM.
6. Run LW.EXE.

You may have to reboot your PC after running LANWatch to deactivate promiscuous mode, which is needed to monitor all packets.

## FTP Software LANWatch NDIS Driver Installation

1. Install LANWatch according to the instructions in your FTP LANWatch manual.
2. Using an ASCII text editor, add the following lines to your CONFIG.SYS file:

```
DEVICE = C:\NDIS\PROTMAN.SYS /I:C:\NDIS  
DEVICE = C:\NDIS\PE3NDIS.EXE  
DEVICE = C:\NDIS\DIS_PKT.GUP
```

(Include the following line for LANWatch versions earlier than 3.0 only)

```
DEVICE = C:\LW\IFCUST.SYS
```

3. Create a directory called \NDIS on your hard disk, as follows:

```
MD \NDIS
```

4. Copy the files PE3NDIS.EXE and PROTOCOL.FTP from the \NDIS directory on the Xircom Network Drivers diskette to the \NDIS directory you created in Step 3.
5. Rename the PROTOCOL.FTP file PROTOCOL.INI.
6. Copy all the files from the \NDIS directory on the FTP Unsupported Software Diskette A to the \NDIS directory you created in Step 3.
7. Reboot the PC.
8. Change to the \NDIS directory and run NETBIND.EXE.
9. Run LW.EXE.



## FTP SOFTWARE PC/TCP (PACKET, NDIS, AND ODI DRIVERS)

FTP Software's PC/TCP Generic Ethernet Kernel ETHDRV.EXE can be installed using Xircom's Packet, ODI, or NDIS drivers. For information on which driver is appropriate for your network environment, see the FTP PC/TCP documentation.

### FTP Software PC/TCP Packet Driver Installation

1. Install PC/TCP software according to the directions given in the PC/TCP documentation.
2. When the installation is complete, copy the file PE3PD.COM from the \PKTDRV directory on the Xircom Network Drivers diskette to the PC/TCP directory specified in the PC/TCP install procedures.
3. (This step not required for PC/TCP versions 2.10 and later.) Using an ASCII text editor, add the following lines to your CONFIG.SYS file:

**DEVICE=[path]IPCUST.SYS**

**DEVICE=[path]IFCUST.SYS**

where [path] is the drive and directory specified at the PC/TCP installation.

#### Note

The PC/TCP manual describes a method for adjusting the configuration of PC/TCP. The Xircom PE3PD.COM driver is self-configuring for its printer port and interrupt and does not use an I/O Base address or PC memory address. Therefore, these values are not adjusted through the *ifconfig* program.

4. Reboot the PC.
5. Change to the directory where your PC/TCP files are stored and run PE3PD.COM.
6. Run the ETHDRV.EXE kernel program supplied with PC/TCP. This loads the PC/TCP kernel into memory. The packet driver must always load before the kernel.
7. Continue your server or workstation start-up as instructed in the PC/TCP documentation.

## FTP Software PC/TCP NDIS Driver Installation

1. Install PC/TCP software according to the directions given in the PC/TCP documentation.
2. Use an ASCII text editor to add the following lines to your CONFIG.SYS file:

```
DEVICE = C:\NDIS\PROTMAN.SYS /I:C:\NDIS  
DEVICE = C:\NDIS\PE3NDIS.EXE  
DEVICE = C:\NDIS\DIS_PKT.GUP
```

(Include the following lines for PC/TCP versions earlier than 2.10 only)

```
DEVICE = C:\PCTCP\IFCUST.SYS  
DEVICE = C:\PCTCP\IPCUST.SYS
```

3. Create a directory called \NDIS on your hard disk, as follows:

```
MD \NDIS
```

4. Copy the files PE3NDIS.EXE and PROTOCOL.FTP from the \NDIS directory on the Xircom Network Drivers diskette to the \NDIS directory you created in Step 3.
5. Rename the PROTOCOL.FTP file PROTOCOL.INI.
6. Copy all the files from the \NDIS directory on the FTP Unsupported Software Diskette A to the \NDIS directory you created in Step 3.
7. Reboot the PC.
8. Change to the \NDIS directory and run NETBIND.EXE.
9. Run the ETHDRV.EXE program supplied with PC/TCP to complete the installation.

## FTP Software PC/TCP ODI Driver Installation

1. Install PC/TCP according to the instructions in your FTP PC/TCP manual.
2. (This step not required for PC/TCP versions 2.10 and later.)  
Using an ASCII text editor, add the following lines to your CONFIG.SYS file:

**DEVICE=[path] IPCUST.SYS**

**DEVICE=[path] IFCUST.SYS**

where [path] is the drive and directory specified at the PC/TCP installation.

3. Copy the following files from the \ODI directory on the Xircom Network Drivers diskette to the PC/TCP directory created in the PC/TCP install procedure:

**LSL.COM**

**PE3ODI.COM**

**ODIPKT.COM**

**NET.CFG**

### Note

If your Ethernet frame type is 802.3, you must use the NET.CFG file supplied on the Xircom Network Drivers diskette. For additional parameters that can be used with the Xircom ODI driver, refer to *Appendix C, Command Line Parameters*.

4. To start the workstation, load the drivers in the following order:

**LSL**

**PE3ODI**

**ODIPKT**

**ETHDRV**

5. Continue your server or workstation start-up as instructed in the PC/TCP documentation.

## ODI with FTP Software PC/TCP and NetWare

If you need to run Novell NetWare concurrently with FTP PC/TCP, proceed as follows:

1. Install PC/TCP according to the instructions in your FTP PC/TCP manual.
2. (This step not required for PC/TCP versions 2.10 and later.)  
Using an ASCII text editor, add the following lines to your CONFIG.SYS file:

**DEVICE=[path] IPCUST.SYS**

**DEVICE=[path] IFCUST.SYS**

where [path] is the drive and directory specified in the PC/TCP installation.

3. Copy the following files from the \ODI directory on the Xircom Network Drivers diskette to the PC/TCP directory created in the PC/TCP install procedure:

**LSL.COM**

**PE3ODI.COM**

**IPXODI.COM**

**ODIPKT.COM**

**NETX.EXE**

**NET.CFG**

### Note

If your Ethernet frame type is 802.3, you must use the NET.CFG file supplied on the Xircom Network Drivers diskette. For additional parameters that can be used with the Xircom ODI driver, refer to *Appendix C, Command Line Parameters*.

4. To start the workstation, load the drivers in the following order:

**LSL**

**PE3ODI**

**IPXODI**

**ODIPKT**

**ETHDRV**

**NETX**

5. Change to the network drive (usually F:\LOGIN)

6. Log in to the network.

## **HP LAN MANAGER (NDIS DRIVER)**

*See Microsoft LAN Manager.*

## IBM OS/2 (VERSION 2.0) EXTENDED SERVICES NDIS DRIVER

### Note

The OS/2 drivers supplied with the Pocket Ethernet Adapter III do not support Microsoft OS/2 version 1.3.

1. Follow the instructions for an Extended Services installation. If your options require you to choose a Network Adapter card, choose a 3Com EtherLink II Network Adapter, complete the installation, and reboot.

When you reboot, you will receive messages indicating that you do not have a 3Com EtherLink II adapter installed. Ignore these messages and continue with the steps below.

2. From an OS/2 Full Screen command prompt, copy two files from your Xircom Network Drivers diskette to the \IBMCOM\MACS directory, using the COPY command, as follows:

```
COPY A:\NDIS\PE3OS2V2.NIF C:\IBMCOM\MACS
```

```
COPY A:\NDIS\PE3NDIS.OS2 C:\IBMCOM\MACS
```

3. Use an ASCII text editor to modify the CONFIG.SYS file, replacing the 3Com EtherLink II driver name with the Pocket Ethernet Adapter III driver name, as follows:

Change the line

```
DEVICE = C:\IBMCOM\MACS\ELNKII.OS2
```

to read

```
DEVICE = C:\IBMCOM\MACS\PE3NDIS.OS2
```

4. Save the file.

5. Change to the \IBMCOM directory.
6. Use an ASCII text editor to open and edit the PROTOCOL.INI file as follows:

- In the [IBMLXCFG] section, add the line

```
PE3OS2V2_nif = PE3OS2V2.NIF
```

- In the [LANDD\_nif] section, modify the BINDINGS statement so that it reads

```
BINDINGS = PE3OS2V2_nif
```

- At the end of the PROTOCOL.INI file, add the following lines:

```
[PE3OS2V2_nif]
```

```
DriverName = XIRCOM$
```

7. Save the file and reboot the PC.

## IBM OS/2 LAN SERVER

### LAN Requester Installation (for IBM OS/2 LAN Server version 2.0) NDIS Driver

1. Follow the instructions in your OS/2 documentation for an **Advanced** LAN Requester installation.
2. When installing and configuring the Requester component, under Select Requester Services, choose "Neither of the above" for messaging services, unless you know you need them and have the information required for configuring these services.
3. When you reach the Configure window, select LAN Adapter and Protocol Support. Under the Options window, choose Copy Additional Network Adapter Drivers.

4. On the Copy Additional Network Adapter Drivers window, type in the path A:\NDIS, then insert the Xircom Network Drivers diskette in drive A and follow the prompts.
5. When the Options window is displayed again, select Configure Workstation and choose the Xircom Pocket Ethernet Adapter III with IBM OS/2 NETBIOS protocol.
6. Follow the prompts to complete the installation.
7. Shut down OS/2 and reboot the PC.

## **LAN Server Installation (for IBM OS/2 LAN Server version 2.0) NDIS Driver**

Installation of OS/2 LAN Server automatically includes the installation of OS/2 LAN Requester. For requester-only installation, see the preceding section.

1. Follow the instructions in your OS/2 documentation for an **Advanced** LAN Server installation.
2. When you reach the Configure window, select LAN Adapter and Protocol Support.
3. On the Options window choose Copy additional network adapter drivers, then OK.
4. On the Copy Additional Network Drivers window, type in the path A:\NDIS, then insert the Xircom Network Drivers diskette in drive A and follow the prompts.



5. On the Options window again, select Configure workstation and choose Select Default PROTOCOLINI, Xircom Pocket Ethernet III Adapter, and the appropriate protocols, then OK.
6. Choose Adapter 0 if the correct adapter is displayed, then OK.
7. Choose Apply the Changes then follow the prompts to complete the installation.
8. Shut down OS/2 and reboot the PC.

## **IBM OS/2 EXTENDED EDITION**

### **LAN Requester (for IBM OS/2 Extended Edition versions 1.2x or 1.3x) NDIS Driver**

1. Configure OS/2 Extended Edition versions 1.2x or 1.3x on your machine using the instructions for a 3Com EtherLink network adapter.

If for any reason you have to reboot at this point, you will receive messages indicating that you do not have a 3Com EtherLink adapter installed. Press Enter to override these messages and continue with the steps below.

2. Open an OS/2 box and use an ASCII text editor to modify the CONFIG.SYS file. Replace the 3Com EtherLink driver name with the Pocket Ethernet Adapter III driver name, as follows:

Change the line

```
DEVICE = \CMLIB\ELNKM.C.OS2
```

to read

```
DEVICE = \CMLIB\PE3NDIS.OS2
```

3. Save the file.
4. Change to the \CMLIB directory.

5. Use an ASCII text editor to open and edit the PROTOCOL.INI file as follows:
  - In the [ETHERAND] section, modify the BINDINGS statement so that it reads

**BINDINGS = XIRCOMNET**

- At the end of the PROTOCOL.INI file, add the following lines:

**[XIRCOMNET]**

**DRIVERNAME = XIRCOM\$**

6. Save the file.
7. Copy the file PE3NDIS.OS2 from the \NDIS directory on the Xircom Network Drivers diskette to the \CMLIB directory on your hard disk.
8. Shut down OS/2.
9. Reboot the PC.

## **LAN Server 1.3 (for IBM OS/2 Extended Edition versions 1.2x or 1.3x)**

To install LAN Server version 1.3 you must have previously installed OS/2 Extended Edition version 1.3 and two of its component programs: Communications Manager and LAN Requester. Instructions for installing LAN Requester with the Xircom network driver are contained in the preceding section. Once the required components are installed, install LAN Server using the SRVINST program, according to the instructions in the LAN Server documentation.

## **MICROSOFT LAN MANAGER**

### **Microsoft LAN Manager (version 2.1x) for DOS and OS/2 NDIS Driver**

1. Begin installation of LAN Manager using "setup."
2. When prompted to select the available network adapter driver, choose "Other Driver" at the bottom of the screen.
3. When prompted, insert the Xircom Network Drivers diskette.
4. Select "Xircom Pocket Ethernet Adapter III" from the menu.
5. Continue with the installation until it is completed.
6. Reboot the PC.

### **Microsoft LAN Manager (version 2.0) for DOS and OS/2 (NDIS Driver)**

1. Begin installation of LAN Manager 2.0 using "setup." At the "Import Network Drivers" screen choose YES.
2. Insert the Xircom Network Drivers diskette.
3. Select "Xircom Pocket Ethernet Adapter III" from the list of drivers to import.
4. Continue with the installation.
5. At the Network Drivers menu, select "Xircom Pocket Ethernet Adapter III" from the list of drivers to install.
6. Continue with the installation until it is completed.
7. Reboot the PC.

## **MICROSOFT WINDOWS 95 (NDIS DRIVER)**

Instructions are provided for manually installing the Xircom network driver for the first time on a system using Windows 95 alone or with NetWare. These instructions assume that Windows 95 and the Pocket Ethernet Adapter III hardware have already been installed. *Do not use the automatic hardware detection feature of Windows 95.* Remove any earlier version of the Xircom drivers before installing the new version.

The following topics are covered for Windows 95:

- How to install for Windows 95 using the NDIS 3.0 driver
- How to install for Windows 95 and NetWare

### **Windows 95 using the NDIS 3.0 driver**

1. In the Windows 95 Control Panel, double-click the Network icon.
2. From the Configuration tab in the Network window, click Add.
3. From the Select Network Component Type window, select Adapter and click Add.
4. From the Select Network adapters window, click Have Disk.
5. When prompted for the manufacturer's installation disk, insert the Xircom Network Drivers diskette.
6. Select "Xircom Windows 95" and click OK.
7. Complete the installation process, inserting the Xircom Network Drivers diskette if required.
8. When asked if you want to restart the computer, click Yes.
9. To verify successful installation, double-click the System icon in the Control Panel, choose the Device Manager tab in the System Properties window, and look for Xircom Pocket Ethernet III under Network adapters.
  - An X or a circled exclamation point on top of the Xircom Pocket Ethernet III icon indicates a problem. Select Xircom Pocket Ethernet III and click Properties to see an explanation. Then proceed to the troubleshooting heading that follows for additional information.

- If there is no X or a circled exclamation point on top of the Xircom Pocket Ethernet III icon, the installation has been successful. If you want to connect to a NetWare network, skip to the heading “Microsoft Windows 95 and NetWare” below.

## **Troubleshooting guidelines**

1. To review the Adapter configuration, double-click the Network icon in the Control Panel.
2. Select the Xircom Pocket Ethernet III component and click Properties.
3. From the Properties window, select the Advanced tab.
4. Confirm that the Properties and their associated Values are correct and that there are no conflicts with other installed devices, using the bulleted steps below. (For a technical discussion of these settings, see *Appendix C. Command Line Parameters* in this User's Guide.)
  - Double-click the System icon in the Control Panel.
  - Choose the Device Manager tab.
  - Double-click the Ports device, select the Printer Port, and click Properties.
  - Examine the Properties of the Printer Port.
  - Choose the Resources tab to examine the information necessary for proper Pocket Ethernet Adapter III configuration, and to verify that there are no conflicts with other devices.

## **Windows 95 and NetWare**

1. Install the Xircom Pocket Ethernet Adapter III driver and verify the installation as described above under the heading “Windows 95 using the NDIS 3.0 driver.”
2. In the Control Panel, double-click the Network icon.
3. From the Configuration tab in the Network window, click Add.
4. From the Select Network Component Type window, select Client and click Add.

5. Under Manufacturers in the Select Network Client window, select Microsoft.
6. In the Network Clients window, select Client for NetWare Networks.
7. Click OK (you will be returned to the Network window).
8. From the Configuration tab in the Network window, click Add.
9. From the Select Network Component Type window, select Protocol and click Add.
10. Select Microsoft as the manufacturer and IPX/SPX-compatible Protocol under Network Protocols, then click OK to return to the Network window.
10. Click OK to close the Network window, then restart the computer when prompted.

## **MICROSOFT WINDOWS FOR WORKGROUPS VERSION 3.11 NDIS AND ODI DRIVERS**

Instructions are provided for installing Xircom network drivers for the first time on a system using Windows for Workgroups version 3.11 alone or with NetWare. These instructions assume that Windows for Workgroups has already been installed. Remove any earlier version of the Xircom drivers before installing the new version.

The following topics are covered for Windows for Workgroups:

- How to remove an existing Windows for Workgroups installation:
- How to install Windows for Workgroups 3.11 using the NDIS 3.0 driver
- How to install Windows for Workgroups 3.11 using the NDIS 2.01 driver
- How to install Windows for Workgroups version 3.11 and NetWare (using the ODI driver)

For additional installation information, troubleshooting information, and sample configuration files, request **Document 3016** from the Xircom FactsLine (see Appendix x for telephone numbers).

## To Remove an Existing Windows for Workgroups Installation:

1. Start Windows and select Network Setup in the Network program group.
2. In the Network Setup dialog box, choose Drivers.
3. In the Network Drivers dialog box, choose Remove to discard any existing network adapter drivers.
4. Choose Close and return to the Network Setup dialog box.
5. Exit the Network Setup program and exit Windows.
6. At the DOS prompt, change to the Windows system directory, as follows

```
cd \windows\system
```

7. Make a directory called OEM, as follows

```
mkdir oem
```

8. Type

```
dir oem?.inf
```

to see a list of driver configuration files.

9. Use the DOS EDIT program to view each OEM file to determine which ones reference Xircom.
10. Copy the old Xircom configuration files to the OEM directory.
11. Delete the old Xircom configuration files from the Windows system directory.
12. Restart Windows.
13. Follow the instructions below for installing the appropriate drivers for Windows for Workgroups alone or Windows for Workgroups and NetWare.

## Windows for Workgroups 3.11 using the NDIS 3.0 driver

1. Start Windows for Workgroups and, in the Network program group, double-click the Network Setup icon.
2. If you have not installed network support, choose Networks in the Network Setup dialog box, select Install Microsoft Windows Network, and click OK. Otherwise skip to Step 3.

3. In the Network Setup dialog box, choose Drivers.
4. In the Network Drivers dialog box, choose Add Adapter.
5. In the Add Network Adapter box, choose Unlisted or Updated Network Adapter and click OK.
6. When prompted for an "unlisted, updated, or vendor-provided network driver disk," insert the Xircom Network Drivers Disk.
7. Select "**Xircom PE3 NDIS 3.0 Protected Mode**" and click OK.
8. Close the Network Drivers dialog box and click OK in the Network Setup box.
9. Complete the installation process, inserting the Xircom Network Drivers Disk if required.

### **Windows for Workgroups 3.11 using the NDIS 2.01 driver**

1. Start Windows for Workgroups and, in the Network program group, double-click the Network Setup icon.
2. If you have not installed network support, choose Networks in the Network Setup dialog box, select Install Microsoft Windows Network, and click OK. Otherwise skip to Step 3.
3. In the Network Setup dialog box, choose Drivers.
4. In the Network Drivers dialog box, choose Add Adapter.
5. In the Add Network Adapter box, choose Unlisted or Updated Network Adapter and click OK.
6. When prompted for an "unlisted, updated, or vendor-provided network driver disk," insert the Xircom Network Drivers Disk.
7. Select "**Xircom PE3 NDIS 2.01 Real Mode**" and click OK.
8. Close the Network Drivers dialog box and click OK in the Network Setup box.
9. Complete the installation process, inserting the Xircom Network Drivers Disk if required.



## Windows for Workgroups version 3.11 and NetWare (using the ODI driver)

To configure Windows for Workgroups with NetWare, you must have a working NetWare (ODI) installation and be logged in to NetWare. Then start Windows for Workgroups.

If you are logged in to NetWare, Windows for Workgroups Setup will detect the NetWare configuration and automatically select Novell NetWare as an additional network. Network Setup will also prompt for Novell support files (from Novell Client diskettes) if required during the installation.

Windows for Workgroups Setup will also attempt to determine what NetWare driver model you are using. If for some reason Windows for Workgroups was unable to detect the driver model, you should select IPXODI and LSL as the driver type.

To configure Windows for Workgroups and NetWare, proceed as follows. Note (in steps 3a and 3b) that you can install NetWare as an additional network under Windows for Workgroups, or by itself but with Windows support.

### To configure Windows for Workgroups and NetWare:

1. Start Windows for Workgroups and, in the Network program group, double-click the Network Setup icon.
2. In the Network Setup dialog box, choose Networks.
- 3a. To install for **both Windows for Workgroups and NetWare**, choose Install Microsoft Windows Network and proceed to step 4.
- 3b. To install for **NetWare only with Windows support**, choose Install Windows Support for the Following Networks Only. Select the NetWare configuration appropriate for your network, then skip to step 5.
4. Choose Other under Additional Network Support, then select the NetWare configuration appropriate for your network.
5. In the Network Setup dialog box, choose Drivers.
6. In the Network Drivers dialog box, choose Add Adapter.

7. In the Add Network Adapter box, choose Unlisted or Updated Network Adapter and click OK.
8. When prompted for an "unlisted, updated, or vendor-provided network driver disk," insert the Xircom Network Drivers Disk.
9. Select "**Xircom PE3 ODI for NetWare**" and click OK.
10. Close the Network Drivers dialog box and click OK in the Network Setup box.
11. Complete the installation process, inserting the Xircom Network Drivers Disk if required.

For additional configuration information and sample files, request **Document 3026** from the Xircom FactsLine (see Appendix D for telephone numbers).

## **MICROSOFT WINDOWS NT VERSIONS 3.5 AND 3.51 (NDIS DRIVER)**

An OEMSETNT.INF file is provided in the root directory on the Network Drivers Disk. This file allows you to import the Xircom Pocket Ethernet Adapter III driver for use with Microsoft Windows NT.

Follow the instructions for installing network adapter cards in the *Microsoft Windows NT System Guide*.

When you are prompted to insert a diskette, insert the Xircom Network Drivers Disk. Files will be copied from the Network Drivers Disk to the local hard drive. When prompted for additional parameters, accept the default values or refer to *Appendix C. Configuration Parameters* in this User's Guide for additional information. Complete the installation according to the instructions in the *Microsoft Windows NT System Guide*.

## **NCR STARGROUP**

See the heading "AT&T/NCR StarGROUP."

## **NCSA TELNET PACKET DRIVER**

NCSA Telnet is a public domain Telnet implementation from the National Center for Supercomputing Applications (NCSA). It can be used with PE3PD.COM, Xircom's Packet Driver, which can be found in the \PKTDRV directory on the Xircom Network Drivers diskette. After installing the packet driver in accordance with your NCSA Telnet documentation, assign the following options in the CONFIG.TEL file:

```
hardware=packet  
ioaddr=60
```

where 60 is the default software interrupt for the Xircom Packet Driver.

## **NDIS DRIVER**

The Xircom NDIS driver conforms to the Microsoft Network Driver Interface Specification (NDIS). It can be found in the \NDIS directory on the Xircom Network Drivers diskette. A sample PROTOCOL.INI segment is also included. For installation instructions, see the alphabetical listing for your network operating system in this section. See *Appendix C, Command Line Parameters*, for more information.

## **NOVELL NETWORK (ODI DRIVER)**

The Xircom ODI driver allows for the concurrent use of Novell NetWare and other protocols that support Novell's Open Data-Link Interface (ODI) specification.

### **NetWare ODI Driver Installation**

#### **NetWare versions 4.x and 3.12**

To install the Pocket Ethernet Adapter III ODI driver for Novell NetWare versions 4.x or 3.12, proceed as follows:

1. Run the NetWare Client Install program from the NetWare Client for DOS/Windows diskette, according to the instructions in the NetWare documentation.
2. Proceed through Steps 1, 2, and 3 on the NetWare Client Install opening screen as required.
3. At Step 4, press Enter.
4. At the "Insert the Driver Disk" screen, remove the NetWare diskette and insert the Xircom Network Drivers diskette, then type the diskette drive path followed by the directory path \ODI, and press Enter. For example, if the diskette is in drive A, type

**A:\ODI**

5. Select "Xircom Pocket Ethernet Adapter III" and press Enter.
6. At the "Settings . . ." screen, press Esc to accept default settings (the Pocket Ethernet Adapter III has no jumpers to set and its drivers are self-configuring).
7. Continue the NetWare installation with Step 5. Leave the Xircom Network Drivers diskette in the drive until prompted for another diskette.

Consult your NetWare documentation for additional information.

## NetWare versions 2.1x and 3.11

1. Copy the following files from the \ODI directory on the Xircom Network Drivers diskette to the appropriate directory of your hard disk or network boot disk:

**LSL.COM**  
**PE3ODI.COM**  
**IPXODI.COM**  
**NETX.EXE**  
**NET.CFG**

### Note

If your Ethernet frame type is 802.3, you must use the NET.CFG file supplied on the Xircom Network Drivers diskette. For additional parameters that can be used with the Xircom ODI driver, refer to *Appendix C, Command Line Parameters*.

2. To start the workstation, change to the appropriate directory and load the drivers in the following order:

**LSL**  
**PE3ODI**  
**IPXODI**  
**NETX**

3. Change to the network drive (usually F:\LOGIN>).
4. Log in to the network.

## NetWare ODI and Packet Drivers

If you have a need to run Novell NetWare concurrently with the Xircom packet driver, copy the file ODIPKT.COM from the \ODI directory of the Xircom Network Drivers diskette to the same directory to which you copied the NetWare ODI drivers. From the same directory, load the drivers in the following order:

**LSL**  
**PE3ODI**  
**IPXODI**  
**ODIPKT**  
**NETX**

## NetWare with the Novell SNA Gateway

If you are running Novell NetWare and communicate to your host computer through a Novell SNA Gateway, configure your Novell SNA workstation software to print to a LAN printer. For additional information, refer to your Novell documentation.

## NETWARE 3.1X AND 4.X SERVER DRIVER

### Note

If you are using other than default values, be sure that the command line arguments used with PE3.LAN match the keyword settings in the NET.CFG file. The arguments listed with PE3.LAN below are the default arguments.

Use the NLM versions supplied on the Xircom Network Drivers Disk with the Xircom NetWare Server Driver.

## NetWare version 3.11

### Note

Be sure you have the latest version of MONITOR.NLM for use with NetWare version 3.11.

Start the server and load the following sequence:

```
PATCHMAN.NLM
LSLENH.NLM
MSM31X.NLM
ETHERISM.NLM
PE3.LAN INT=7 PORT=378 FRAME=ETHERNET_802.2
BIND IPX TO PE3 NET=XX
```

### **NetWare version 3.12**

Start the server and load the following sequence:

```
MSM31X.NLM
PE3.LAN INT=7 PORT=378 FRAME=ETHERNET_802.2
BIND IPX TO PE3 NET=XX
```

### **NetWare version 4.01**

Start the server and load the following sequence (NLMs not required):

```
PE3.LAN INT=7 PORT=378 FRAME=ETHERNET_802.2
BIND IPX TO PE3 NET=XX
```

## NetWare Requester for OS/2 (versions 2.x)

These instructions explain how to load the Xircom network driver as part of the NetWare Requester installation process.

1. Run the NetWare Requester INSTALL program as instructed in the NetWare Requester documentation and choose Requester on workstation from the Installation menu.
2. After verifying your target directory and source drive for NetWare Requester files, choose Edit CONFIG.SYS and Copy Files at the Requester Installation dialog box.
3. When prompted for the Network Interface Card driver, type in the name of the Xircom driver: PE3ODI.OS2. After completing the other options in the dialog box, click Save.
4. When asked if the driver you specified is the one you want to install, choose Yes, then type in the path to the Xircom driver:

**A:\ODI\PE3ODI.OS2**

5. Remove the NetWare Requester install diskette and insert the Xircom Network Drivers diskette.
6. At the dialog box "Requester files will copy to:", click Copy.
7. Complete the installation and exit the NetWare Requester installation utility.
8. Shut down OS/2 and reboot the computer.

For additional information and sample configuration files, request **Document 3041** from the Xircom FactsLine (see Appendix D for telephone numbers).



## NetWare Requester for OS/2 (version 1.3)

### Note

If the NetWare installation utility allows installing from a floppy disk, insert the Xircom Network Drivers diskette into the disk drive when prompted and install the Xircom driver PE3ODLOS2 from the \ODI directory on the Xircom diskette. Otherwise, follow the instructions below.

1. Install NetWare Requester for OS/2 and choose any Ethernet adapter (for example, NE2).
2. Using an ASCII text editor, edit the CONFIG.SYS file as follows:  
Replace the line specifying the Ethernet adapter driver you installed in Step 1, for example:

**device=c:[path]NE2.SYS**

with a line specifying the Xircom driver:

**device=c:[path]PE3ODI.OS2**

3. Copy the files PE3ODI.OS2 and NET.CFG from the \ODI directory on the Xircom Network Drivers diskette into the subdirectory containing the file NE2.SYS.
4. Shut down OS/2 and reboot the computer.

### Note

The EPP.OS2 utility, if used, should be listed in the CONFIG.SYS *before* the line containing the PE3ODLOS2 file.

## **NOVELL PERSONAL NETWARE ODI DRIVER**

1. Install Personal NetWare according to the instructions in the Personal NetWare manual.
2. When prompted for type of network adapter, choose "Xircom Pocket Ethernet Adapter III" and complete the installation.
3. Save the file.
4. Remove the Xircom diskette and reboot the PC.
5. Change to the \NWCLIENT directory and type STARTNET to start the network on that station.

## **OS/2**

See entries under "IBM OS/2."

## **ODI DRIVER**

See the alphabetical listing of network operating systems for those that can use the ODI driver. See *Appendix C, Command Line Parameters*, for more detailed information.

## **PACKET DRIVER**

Xircom's packet driver is based on FTP Software's public domain specification. The driver file PE3PD.COM is located in the \PKTDRV directory of the Xircom Network Drivers diskette. To determine whether you should use the packet driver, refer to the instructions for your network operating system, listed alphabetically in this section. See *Appendix C, Command Line Parameters*, for more information.

## SUNSELECT PC-NFS (VERSION 3.5) NDIS DRIVER

1. Install PC-NFS for Ethernet according to instructions in the PC-NFS documentation. Choose NDIS setup, and follow the instructions to complete the setup. Note the prompt that tells you that further manual modifications will have to be made.
2. Reboot. You will see some error messages. Disregard them and continue with these instructions.
3. Rename the file `PROTOCOL.NFS` in the `C:\LANMAN` directory to `PROTOCOL.INI`. Use an ASCII text editor to edit the `PROTOCOL.INI` file as follows:

Replace the items

```
[your-mac-module]
    drivename = YOURMAC$
    option1 = value1 etc.

[NFS-NDIS]
    drivename = NFSLINK1
    bindings = your-mac-module
```

with

```
[XIRCOMNET]
    drivename = XIRCOM$

[NFS-NDIS]
    drivename = NFSLINK$
    bindings = XIRCOMNET
```

4. Copy the file `PE3NDIS.EXE` from the `\NDIS` directory on the Xircom Network Drivers diskette to the `C:\LANMAN` directory.
5. Use an ASCII text editor to insert the following line in your `CONFIG.SYS` file:

```
DEVICE=C:\LANMAN\PE3NDIS.EXE
```

between the two lines that read

```
DEVICE=C:\LANMAN\PROTMAN.SYS
```

```
DEVICE=C:\LANMAN\NFS-NDIS.SYS
```

6. Verify that your AUTOEXEC.BAT file contains a line that reads

```
C:\LANMAN\NETBIND
```

before the line that reads

```
NET INIT
```

7. Configure PC-NFS options according to your PC-NFS documentation, and reboot the PC.

## **UNGERMANN-BASS NET/ONE LAN MANAGER (VERSION 2.1) FOR DOS AND OS/2 NDIS DRIVER**

The Xircom Pocket Ethernet Adapter III is supported on Ungermann-Bass Net/One LAN Manager and MS-NET networks. There are two NDIS driver packages available from UB: XNS BNS/NDIS and TCP BNS/NDIS. These packages, used with a Xircom NDIS driver, provide files that support both DOS and OS/2 workstations. They are available from UB or an authorized UB representative.

### **Ungermann-Bass Net/One LAN Manager version 2.1 Installation**

1. Begin installation of LAN Manager 2.1 using "setup."
2. When prompted to select the available network adapter driver, choose "Other Driver" at the bottom of the screen.
3. When prompted, insert the Xircom Network Drivers diskette.
4. Select "Xircom Pocket Ethernet Adapter III" from the menu.
5. Continue with the installation until it is completed.

- Following the UB instructions, modify your CONFIG.SYS file by adding the following line:

For DOS:

```
DEVICE = [path]PE3NDIS.EXE
```

For OS/2:

```
DEVICE = [path]PE3NDIS.OS2
```

where *[path]* is the drive and directory in which you installed your network operating system.

- Use an ASCII text editor to modify your PROTOCOL.INI file as follows:

- For each protocol that you want to bind, set the protocol definition area of the PROTOCOL.INI file to:

```
BINDINGS = UBLOOP
```

- At the end of the file, add the following fragments:

```
[UBLOOP]
```

```
DRIVERNAME = UBLOOP$
```

```
BINDINGS = XIRCOMNET
```

```
;XIRCOM ADAPTER
```

```
[XIRCOMNET]
```

```
DRIVERNAME = XIRCOM$
```

- Reboot the PC.

# WOLLONGONG PATHWAY ACCESS (VERSION 3.0) NDIS DRIVER

## Wolongong PathWay NDIS Installation

1. Install PathWay Access for DOS Kernel and Drivers programs according to the instructions in the PathWay Access for DOS manual. Before rebooting the PC, continue with the following steps.
2. Use an ASCII text editor to modify the CONFIG.SYS file. After the statement that reads

**DEVICE=C:\PATHWAY\PWTC.P.SYS**

add the lines

**DEVICE=\PATHWAY\[PROTMAN FILE] /I:C:\PATHWAY**

**DEVICE=\PATHWAY\PE3NDIS.EXE**

where [PROTMAN FILE] is equal to the PROTMAN2.EXE or PROTMAN.EXE file that is located in your \PATHWAY directory. (Refer to the Wollongong PathWay Access for DOS manual for information regarding the differences between these two files.)

3. Copy the files PE3NDIS.EXE and PROTOCOL.INI from the \NDIS subdirectory on the Xircom Network Drivers diskette to the \PATHWAY directory on your hard disk or boot disk.
4. Continue with the "custom" instructions in the PathWay Access for DOS manual.
5. Reboot the PC.



# APPENDIX A. ERROR MESSAGES

The Xircom network drivers report the following problems if they occur during the initialization of a network session. For error messages related to network operation, see your network operating system documentation.

## **A Pocket Ethernet Adapter could not be found**

Ensure that AC power connections are secure (whether from a wall outlet or through the Phantom Power Cable) and that the power cable is connected properly to the power input socket on the rear of the Pocket Ethernet Adapter III.

Ensure that the Adapter is securely connected to the parallel port (LPT1, LPT2, LPT3) specified during installation.

## **A Pocket LAN Adapter driver is already loaded**

You may have specified a nonexistent parallel port during installation, or a Pocket Ethernet Adapter III device driver is already loaded. Repeat the installation procedure.

## **Pocket Ethernet Adapter III address EEPROM unreadable**

The Pocket Ethernet Adapter III had an internal failure. Run the self test program described in the section on *Configuration and Diagnostics* before calling Xircom Technical Support.

## **This driver does not support the currently connected adapter**

The Pocket LAN Adapter hardware connected to the parallel port is not compatible with the type of driver software being used.

## **The selected interrupt is unavailable**

## **The selected I/O address is unavailable**

## **The selected LPT Port is unavailable**

These messages indicate that values for the parameters listed have been changed in the NET.CFG or PROTOCOL.INI file, or on the command line with packet, Artisoft, or DEC PCSA drivers, and that the system cannot implement the changes.





## APPENDIX B. SOFTWARE SUPPLIED

The files and directories contained on the Xircom Network Drivers diskette are listed below. For installation instructions, see the section *Software Setup and Operation*, where supported network operating systems are listed in alphabetical order. Contact Xircom Technical Support for information about networking environments not covered in this User's Guide.

<b>README.TXT</b>	The latest information about the software. To view, type <b>MORE &lt;A:README.TXT</b> at the DOS prompt.
<b>PE3TEST.EXE</b>	Self test diagnostic program
<b>EPP.COM</b>	DOS command line utility for management of Enhanced Parallel Port (EPP) mode on non-EPP BIOS computers
<b>EPP.SYS</b>	DOS configuration program for management of Enhanced Parallel Port (EPP) mode on non-EPP BIOS computers
<b>EPP.OS2</b>	OS/2 configuration program that enables Enhanced Parallel Port (EPP) mode from the CONFIG.SYS file on EPP-capable computers
<b>PE3NDIS.EXE</b>	NDIS driver for Windows for Workgroups
<b>OEMSETUP.INF</b>	Windows for Workgroups configuration file
<b>PE3NDIS.EXE</b>	NDIS version 2.01 driver for Windows for Workgroups
<b>PE3NDIS.386</b>	Windows for Workgroups NDIS version 3.0 driver
<b>PE3ODI.COM</b>	ODI driver for DOS workstation
<b>PE3ODI.OS2</b>	ODI driver for Novell NetWare Requester for OS/2
<b>PE3NDIS.SYS</b>	Windows NT version 3.0 driver
<b>OEMSETNT.INF</b>	Windows NT configuration file

### **\ARTISOFT directory**

**PE3ART.NIF**            Artisoft LANtastic installation support file  
**PROTOCOL.INI**        Protocol initialization segment

### **\ATT34 directory**

**XIRATT34.NIF**        AT&T/NCR StarGROUP 3.3 and 3.4  
                         configuration file  
**PROTOCOL.INI**        Protocol initialization segment

### **\ATT35 directory**

**XIRATT35.NIF**        AT&T/NCR StarGROUP 3.5 configuration file  
**PROTOCOL.INI**        Protocol initialization segment

### **\DEC directory**

**PE3DLL.EXE**            Datalink driver for use with DECnet-DOS or  
                         PCSA 3.x  
**PROTOCOL.INI**        Protocol initialization segment

### **\MSLANMAN.DOS\DRIVERS\ETHERNET\XIRCOM directory**

**PE3NDIS.EXE**        NDIS driver for DOS  
**PROTOCOL.INI**        Protocol initialization segment

### **\MSLANMAN.DOS\DRIVERS\NIF directory**

**PE3DOS.NIF**            LAN Manager DOS configuration file

### **\MSLANMAN.OS2\DRIVERS\ETHERNET\XIRCOM directory**

**PE3NDIS.OS2**        NDIS driver for OS/2  
**PROTOCOL.INI**        Protocol initialization segment

### **\MSLANMAN.OS2\DRIVERS\NIF directory**

**PE3OS2.NIF**            LAN Manager OS/2 configuration file

### **\NDIS directory**

**PE3NDIS.EXE**        NDIS driver for DOS

<b>PE3NDIS.OS2</b>	NDIS driver for OS/2
<b>PROTOCOL.INI</b>	Protocol initialization segment
<b>PROTOCOL.FTP</b>	Protocol initialization segment for FTP Software's PC/TCP and LANWatch
<b>PE3OS2.NIF</b>	Configuration file for OS/2 version 2.0

#### **\NWSERVER directory**

<b>PE3.LAN</b>	Xircom NetWare Server driver
<b>LSLENH.NLM</b>	NetWare server configuration file
<b>PATCHMAN.NLM</b>	NetWare server configuration file
<b>MSM31X.NLM</b>	NetWare server configuration file
<b>ETHERTSM.NLM</b>	NetWare server configuration file

#### **\ODI directory**

<b>IPXODI.COM</b>	IPX protocol stack
<b>PE3ODI.INS</b>	Installation file for NetWare 4.0
<b>PE3ODI.COM</b>	ODI driver for DOS workstations
<b>PE3ODI.OS2</b>	ODI driver for Novell NetWare Requester for OS/2
<b>LSL.COM</b>	Link support module
<b>NETX.EXE</b>	NetWare shell for use with DOS 3.x or higher
<b>NET.CFG</b>	ODI configuration file (DOS only)
<b>ODIPKT.COM</b>	Allows operation of Novell NetWare concurrently with a packet driver

#### **\PKTDRV directory**

<b>PE3PD.COM</b>	Packet driver file conforming to FTP Software's public domain driver specification
------------------	--

See the alphabetical listing of network operating systems in the *Software Setup and Operation* section for instructions on how to use the files required for your network. Contact Xircom Technical Support for information about other networking environments.



# APPENDIX C. COMMAND LINE PARAMETERS

This appendix contains instructions for using driver parameter settings other than those described in the *Software Setup and Operation* section. The driver types are listed in alphabetical order: DECnet, NDIS, ODI, and packet. In most cases the Xircom driver will be able to automatically configure for the correct parallel port, interrupt value, and EPP, bidirectional, or non-bidirectional mode.

## NDIS DRIVER PARAMETERS

See the alphabetical listing of network operating systems in the *Software Setup and Installation* section to determine whether your network uses an NDIS driver.

PE3NDIS.EXE and PE3NDIS.OS2 are NDIS drivers that support the Pocket Ethernet Adapter III. The PROTOCOL.INI configuration file used with these drivers must contain the module name and DRIVERNAME as follows:

```
[XIRCOMNET]
    DRIVERNAME = XIRCOM$
```

When the PE3NDIS command is executed, the Adapter will automatically find and use an appropriate parallel port and interrupt value and select bidirectional or non-bidirectional mode. Should it be necessary to override the self-configured values, use an ASCII text editor to add the appropriate combination of the parameters listed below to the **PROTOCOL.INI** file. Keywords are not case sensitive. Each keyword should be on a separate line and should be indented to align with DRIVERNAME. A sample PROTOCOL.INI file might look like this:

```
[XIRCOMNET]
    DRIVERNAME = XIRCOM$
    LPT=3
    INT=7
    LINKDISABLE
```

Keywords and values for the PROTOCOL.INI are as follows:

<b>Keyword</b>	<b>Default</b>	<b>Valid Settings</b>
<b>NON</b>	<b>AUTO</b>	
<b>LPT=</b>	<b>AUTO</b>	<b>(1 to 3)</b>
<b>INT=</b>	<b>AUTO</b>	<b>(3 to 15)</b>
<b>IOADDRESS=</b>	<b>AUTO</b>	<b>(0x240 to 0x380)</b>
<b>LINKDISABLE</b>	<b>LINK</b> <b>INTEGRITY</b> <b>ENABLED</b>	
<b>NOEPP</b>	<b>AUTO</b>	
<b>RDS</b>	<b>AUTO</b>	
<b>SLOWPORT</b>	<b>AUTO</b>	

where

**NON** forces the driver to run in non-bidirectional mode. Without the "NON" keyword, the driver autoconfigures to bidirectional or non-bidirectional mode.

**LPT=** requires a number from 1 to 3 which designates the physical parallel port to which the Adapter is connected: LPT1, LPT2, or LPT3. Default (if parameter not specified) is autoconfiguration.

**INT=** requires a number designating the parallel port hardware interrupt (for example, INT=5 or INT=7). Default (if parameter not specified) is autoconfiguration. Use 0 (zero) to force the Adapter into a polled mode.

**IOADDRESS=** requires an I/O address in hexadecimal notation (0x240 to 0x380). Default (if parameter not specified) is autoconfiguration.

**LINKDISABLE** disables link integrity for operation with non-10BASE-T networks such as StarLAN 10. Without the "LINKDISABLE" keyword in the PROTOCOL.INI file, the driver defaults to link integrity ENABLED.

**NOEPP** prevents the driver from using EPP BIOS or EPP mode.

**RDS** forces the driver to use the autofeed pin (pin 14) as a data strobe.

**SLOWPORT** forces slow parallel port accesses.

Instructions for loading the appropriate NDIS files and drivers are provided in the *Software Setup and Installation* section listing network operating systems in alphabetical order by vendor.

## ODI DRIVER PARAMETERS

See the alphabetical listing of network operating systems in the *Software Setup and Installation* section to determine whether your network uses an ODI driver.

The ODI driver PE3ODI.COM uses its default settings unless other options are specified in the NET.CFG configuration file. This file is supplied on the Xircom Network Drivers diskette and must be present in the same directory as the ODI driver.

While the Xircom ODI driver defaults to Ethernet frame type 802.2, the NET.CFG file supplied on the Xircom diskette sets both 802.2 and 802.3. Therefore the Xircom NET.CFG file **must** be used if your network frame type is 802.3.

To change any parameters, use an ASCII text editor to open and modify the NET.CFG file and insert the appropriate keywords and values after the line

### LINK DRIVER PE3ODI

The LINK DRIVER line must be flush left while the keywords must each be on a separate line and indented at least one space or tab. A sample NET.CFG file might look like this:

#### LINK DRIVER PE3ODI

**FRAME ETHERNET\_802.3**

**FRAME ETHERNET\_II**

**NON**

**INT 7**

**LINKDISABLE**

#### Note

Do not use an "-" sign with ODI parameters in the NET.CFG file. Use a space between the keyword and value. For example, use INT 7, not INT=7.



Keyword syntax for **NET.CFG** is as follows (keywords are not case sensitive):

<b>Keyword</b>	<b>Default</b>	<b>Valid Settings</b>
<b>FRAME</b>	<b>ETHERNET_802.2</b>	<b>ETHERNET_II</b> <b>ETHERNET_802.2</b> <b>ETHERNET_802.3</b> <b>ETHERNET_SNAP</b>
<b>NON</b>	<b>AUTO</b>	
<b>LPT</b>	<b>AUTO</b>	(1 to 3)
<b>INT</b>	<b>AUTO</b>	(3 to 15)
<b>PORT</b>	<b>AUTO</b>	(240 to 380)
<b>LINKDISABLE</b>	<b>LINK</b> <b>INTEGRITY</b> <b>ENABLED</b>	
<b>NOEPP</b>	<b>AUTO</b>	
<b>RDS</b>	<b>AUTO</b>	
<b>SLOWPORT</b>	<b>AUTO</b>	

where

**FRAME** designates support for multiple Ethernet frame types. One or more types can be used. Refer to your NetWare documentation for more information. The Xircom ODI driver's default frame type is 802.2, but the NET.CFG file supplied with the ODI driver on the Xircom Drivers diskette sets both 802.2 and 802.3. Therefore if your network's frame type is 802.3, you **must** use Xircom's NET.CFG with the ODI driver.

**NON** forces the driver to run in non-bidirectional mode. Without the "NON" keyword, the driver autoconfigures to bidirectional or non-bidirectional mode.

**LPT** requires a space followed by a number from 1 to 3 which designates the physical parallel port to which the Adapter is connected: LPT1, LPT2, or LPT3. Default (if parameter not specified) is autoconfiguration.

**INT** requires a space followed by a number designating the parallel port hardware interrupt (for example, INT=5 or INT=7). Default (if parameter not specified) is autoconfiguration. Use 0 (zero) to force the Adapter into a polled mode.

**PORT** requires a space followed by an I/O address in hexadecimal notation (0x240 to 0x380). Default (if parameter not specified) is autoconfiguration.

**LINKDISABLE** disables link integrity for operation with non-10BASE-T networks such as StarLAN 10. Without the "LINKDISABLE" keyword in the NET.CFG file, the driver defaults to link integrity ENABLED.

**NOEPP** prevents the driver from using EPP BIOS or EPP mode.

**RDS** forces the driver to use the autofeed pin (pin 14) as a data strobe.

**SLOWPORT** forces slow parallel port accesses.

Instructions for loading the appropriate ODI files and drivers are provided in the *Software Setup and Installation* section listing network operating systems in alphabetical order by vendor.

## PACKET DRIVER PARAMETERS

Packet driver parameters must be stated on the command line with the PE3PD.COM packet driver.

See the alphabetical listing of network operating systems in the *Software Setup and Installation* section to determine whether your network uses a packet driver.

The packet driver supplied on the Xircom Network Drivers diskette is based on FTP Software's public domain specification. The driver file PE3PD.COM is located in the \PKTDRV directory on the Drivers diskette.

Refer to your network documentation for instructions on how to install the packet driver with your network. Most installations should be able to use the default settings listed below. To change the default settings, use the appropriate keywords and settings on the PE3PD.COM command line when loading the packet driver.

The Xircom packet driver PE3PD.COM is self-configuring and therefore finds its own LPT and interrupt values and correctly selects bidirectional or non-bidirectional mode under most circumstances. Should it be necessary to override the self-configured parameters, use the following options on the command line when running PE3PD.COM (keywords are not case sensitive). For example,

**PE3PD NON INT=7**

<b>Keyword</b>	<b>Default</b>	<b>Valid Settings</b>
<b>?</b>		
<b>NON</b>	<b>AUTO</b>	
<b>SINT=</b>	<b>60</b>	<b>(60-80)</b>
<b>LPT=</b>	<b>AUTO</b>	<b>(1 to 3)</b>
<b>INT=</b>	<b>AUTO</b>	<b>(3 to 15)</b>
<b>IOADDRESS=</b>	<b>AUTO</b>	<b>(240 to 380)</b>
<b>LINKDISABLE</b>	<b>LINK</b>	
	<b>INTEGRITY</b>	
	<b>ENABLED</b>	
<b>NOEPP</b>	<b>AUTO</b>	
<b>RDS</b>	<b>AUTO</b>	
<b>SLOWPORT</b>	<b>AUTO</b>	

where

**?** displays a summary of command line options.

**NON** forces the driver to run in non-bidirectional mode. Without the "NON" keyword, the driver autoconfigures to bidirectional or non-bidirectional mode.

**SINT=** is a number from hex 60 to 80 designating a software interrupt. The default is 60.

**LPT=** requires a number from 1 to 3 which designates the physical parallel port to which the Adapter is connected: LPT1, LPT2, or LPT3. Default (if parameter not specified) is autoconfiguration.

**INT=** requires a number designating the parallel port hardware interrupt (for example, INT=5 or INT=7). Default (if parameter not specified) is autoconfiguration. Use 0 (zero) to force the Adapter into a polled mode.

**IOADDRESS=** requires an I/O address in hexadecimal notation (0x240 to 0x380). Default (if parameter not specified) is autoconfiguration.

**LINKDISABLE** disables link integrity for non-10BASE-T networks such as StarLAN 10. Without the "LINKDISABLE" keyword in the PE3PD command line, the driver defaults to link integrity ENABLED.

**NOEPP** prevents the driver from using EPP BIOS or EPP mode.

**RDS** forces the driver to use the autofeed pin (pin 14) as a data strobe.

**SLOWPORT** forces slow parallel port accesses.

Instructions for running the packet driver are provided in the *Software Setup and Installation* section listing network operating systems in alphabetical order by vendor.

# APPENDIX D. 24-HOUR GLOBAL SUPPORT SERVICES

## CUSTOMCARE SERVICE AND SUPPORT

Xircom offers CustomCare<sup>SM</sup>, an extensive family of service and support programs, including world-class phone support, product upgrades, plus 24-hour access to our BBS, World Wide Web, FactsLine, CompuServe Forum and other electronic facilities. Also available is a 24-hour, 7-days-per-week support program tailored to meet individual service and support needs. Request document number **8406** on FactsLine Documents-By-Fax for details about CustomCare.

### Note

Please fill out and return the Product Registration Card supplied with the product. Your information will be entered into our support database.

## Xircom's Bulletin Board

Using a modem, you can access the latest technical and product information and the latest versions of our network drivers and associated software. You can also leave a message for a Support Engineer.

To use the BBS, set your modem to `xxxxx,N,8,1` (where `xxxxx` is your modem's maximum speed, `N` is no parity, `8` is data bits, and `1` is stop bit) to connect at up to 28,800 bps. Xircom modems will automatically adjust to lower speeds. BBS numbers are listed on the following pages.

To download drivers, go to the BBS Main Menu, type **F** (for File Directories) and press Enter. Follow the instructions to select and download current versions of Xircom *released* drivers (subject to the terms of the Xircom Software License Agreement published in this manual as Appendix F).

## **XIRCOM WORLDWIDE ACCESS**

### **U.S.A.**

Xircom, Inc.  
2300 Corporate Center Drive  
Thousand Oaks, California 91320-1420

#### **Direct Line to Technical Support**

(805) 376-9200 Technical Support  
(5 a.m. to 6 p.m. Monday through Friday U.S. Pacific time)  
(805) 376-9100 Fax to Technical Support

#### **Online or Automated Access (24 hours, 7 days a week)**

(805) 376-9130 Bulletin Board System  
(800) 775-0400 FactsLine Documents-by-Fax (U.S. only)

cs@xircom.com	Internet E-mail
<a href="http://www.xircom.com">http://www.xircom.com</a>	World Wide Web
GO XIRCOM	CompuServe
Go To ... Xircom	The Microsoft Network

### **Europe, Middle East, and Africa**

Xircom Europe N.V.  
King Square, De Villermontstraat 16  
2550 Kontich, Belgium  
+32/(0)3 450.08.60 Technical Support  
(9:00 to 17:00 Monday-Thursday, 9:00 to 16:00 Friday)  
+32/(0)3 450.09.95 Fax to Technical Support  
+32/(0)3 450.08.00 FactsLine Documents-by-Fax  
+32/(0)3 457.64.10 Bulletin Board System (24-hour access)  
  
eurots@xircom.com Internet E-mail

## Asia Pacific

Xircom Asia Pacific (Pte) Ltd.

#13-03 Cecil Court

138 Cecil Street

Singapore 069538

+65 323 1511

+65 323 3404 Technical Support

+65 224 3313 Fax

+65 323 0455 Bulletin Board System (24-hour access)

Xircom Australia

Level 20, 99 Walker Street

North Sydney, NSW

Australia 2060

+61 (02) 9911 7790

+61 (02) 9911 7796 Fax

+61 (02) 9911 7758 Bulletin Board System (24-hour access)

## Additional International Access

Contact your local reseller or distributor

1-805-376-9020

cs@xircom.com

eurots@xircom.com

<http://www.xircom.com>

GO XIRCOM

Go To ... Xircom

FactsLine Documents-by-Fax

Internet e-mail - U.S.

Internet e-mail - Europe

World Wide Web

CompuServe

The Microsoft Network





# APPENDIX E. LIFETIME LIMITED WARRANTY

## Warranties

As the original purchaser, you receive these warranties from Xircom:

### Hardware

Your Pocket Ethernet Adapter III (collectively, "Products"), including any Xircom AC power supply component(s), will be free from defects in material and workmanship and will perform in substantial compliance with your user documentation accompanying the Products for as long as you own and properly use the Products.

### Software

Software accompanying these Products (including driver, utility software, etc.) and the magnetic media containing the software are warranted to perform in substantial compliance with the specifications contained in your user documentation for two years from your purchase date. Our warranty does not cover or provide you with rights to upgrades or updates.

You are responsible for your choice of applications programs or related reference materials. Given the wide range of third party hardware and applications software products you might use our software with, you understand that Xircom does not warrant the compatibility or the uninterrupted or error free operation of our software.

Upon our confirmation of a covered defect or failure, at our option we will repair or replace the affected item or will refund your purchase price if repair or replacement is not possible or practical. Replacement products or repaired items may be a new or a refurbished item. Our warranty on items serviced under warranty will be lifetime for **hardware** and, for **software**, 90 days from return to you of software/magnetic media or the remainder of the original warranty, whichever is longer. Repair, replacement, or refund are the exclusive remedies available to you from Xircom for products and software.

## Your Obligations

Your warranty rights will be honored provided you

1. Read and follow your user documentation for installation, setup, software setup, and operating guidelines,
2. Use the Products and software only in suitable physical or operating environments as described in your user documentation and for purposes for which the Products and software are intended.

## Warranty Service

If you think there is a problem or defect with your purchased item, your point of contact will be

### In the U.S.A.

Xircom's Technical Support department at **(805) 376-9200**.

### Outside the U.S.A.

Contact your local Xircom supplier or Xircom regional office.

Your Xircom contact will discuss your problem to confirm the defect. If warranty or return service is needed, you'll receive a *Return Material Authorization* (RMA) number.

Ship your return Product, **with the RMA number clearly visible on the outside of the shipping package**, to:

### From the U.S.A.

Xircom Service Department  
2101 Corporate Center Drive  
Thousand Oaks, CA 91320-1422

### From outside the U.S.A.

Contact you local Xircom supplier or Xircom regional center for shipping instructions.

Returned Products must include all other components from your original package, including the Product and any cables, connectors, software diskettes, and user documentation. Be sure to enclose a copy of your purchase receipt or other proof of purchase confirming that you are the original purchaser.

## **Limitations**

Our warranty is subject to the following limitations:

- a. We do not cover or accept liability for any injury, damage or failure caused by misuse, abuse, acts of Nature, accidents (e.g., dropping the Products or software diskettes), electrical mishaps, causes beyond our control, or claims by other than the original purchaser.
- b. We will not honor, and will consider our warranty voided, if there has been any (1) tampering with the Product's external label or serial number, (2) attempt to open the Product's case, or (3) attempted or actual repair by anyone other than an authorized Xircom technician.

## **Disclaimer**

THIS LIMITED WARRANTY IS THE ONLY WARRANTY WE MAKE FOR THE PRODUCT AND SOFTWARE. TO THE EXTENT ALLOWED BY LAW, NO OTHER WARRANTY APPLIES, WHETHER EXPRESS, IMPLIED, OR STATUTORY, INCLUDING ANY WARRANTY OF MERCHANTABILITY, OF FITNESS FOR A PARTICULAR PURPOSE, OR OF NON-INFRINGEMENT. XIRCOM WILL NOT BE LIABLE OR RESPONSIBLE FOR ANY INCIDENTAL, CONSEQUENTIAL, OR SPECIAL DAMAGES (e.g., LOST PROFITS, LOSS OF OR DAMAGE TO ANY COMPUTER EQUIPMENT OR RELATED DATA).

## **Additional Rights**

Some states or countries do not allow exclusion or limitation of incidental or consequential damages, or limitations on the length of an implied warranty, so the above limitations or exclusions may not apply to you. Our warranty gives you specific legal rights, and you may also have other rights which vary from state to state or country to country.

## INTERNATIONAL NOTICE

Due to differing national regulations and approval requirements, certain Xircom products are designed for use only in specific countries, and may not function properly in a country other than the country of designated use. As a user of these products, you are responsible for ensuring that the products are used only in the countries for which they were intended.

For information on specific products, contact Xircom's nearest regional center:

<b>Xircom Corporate (U.S.A.)</b>	(800) 438-4526
<b>Xircom Europe</b>	+32/(0)3 450.08.11
<b>Xircom Asia Pacific</b>	+65 323 1511

## UNAUTHORIZED APPLICATIONS

Xircom's products are not designed or authorized for use as a component in any life support, life safety, or other comparable application. Our products should not be used in any application where the failure or faulty performance of the product might create a risk of personal injury or death. Buyer assumes all risk of loss, damage or injury alleged to arise from the failure or faulty performance of a Xircom product in any unauthorized application. Buyer agrees to indemnify and hold harmless Xircom, and its officers, directors, employees, agents, representatives, and sales partners, from and against any and all claims, costs, damages, losses and expenses (including reasonable attorney fees) which arise from or are alleged to have been caused by any claim for personal injury or death connected with Buyer's use of a Xircom product in any unauthorized application, including claims which allege that Xircom has been negligent in connection with the design or manufacture of the product.

# APPENDIX F. SOFTWARE LICENSE AGREEMENT

Xircom grants you a non-exclusive license to use the copies of software programs supplied with this product on the following terms:

## **You may:**

- a. Use the software program on any computer or network but only in conjunction with any Xircom hardware product;
- b. Permit any other individuals to use the software program either directly or on a computer network, but only if there is no more than one user for each Xircom hardware product in use in conjunction with such use;
- c. Make only those number of backup and archival copies of the software program in machine readable form as are essential to backup use of the software program, provided that you reproduce all proprietary notices on each copy.

## **You may not:**

- a. Modify, translate, reverse engineer, decompile, disassemble, create derivative works based on, or copy (except for archival purposes) the program or the accompanying documentation;
- b. Rent, transfer, sublicense or grant any rights in the program or accompanying documentation (including any time-sharing arrangement) in any form to any other person without the prior written consent of Xircom;
- c. Remove any proprietary notices, labels, or marks on the program and accompanying documentation.

Failure to comply with any of the above restrictions will terminate this license. This is not a sale. Title and copyrights to the program and accompanying documentation and any copies remain with Xircom, except that title to software programs shipped by Xircom through an agreement with another manufacturer is owned and retained by the original manufacturer, and no title to the intellectual property contained in such programs is transferred hereunder. The human readable code of the software program (source code), including the source code of programs shipped by Xircom through an agreement with another manufacturer, is not sublicensed hereunder.

## **U.S. GOVERNMENT RESTRICTED RIGHTS**

The SOFTWARE and documentation are provided with RESTRICTED RIGHTS. Use, duplication, or disclosure by the Government is subject to restrictions as set forth in subparagraph (c)(1)(ii) of the Rights in Technical Data and Computer Software clause at DFARS 252.227-7013, or subparagraphs (c)(1) and (c)(2) of the Commercial Computer Software-Restricted Rights at 48 CFR52.227-19, as applicable. Contractor/manufacturer is Xircom, Inc., 2300 Corporate Center Drive, Thousand Oaks, CA 91320-1420.

This Agreement is governed by the laws of the State of California.

# APPENDIX G. REGULATORY AGENCY NOTICES

## FCC, PART 15

The Xircom CreditCard Ethernet Adapter IIps complies with the FCC Rules for a Class B digital device. As required by FCC Rules and Regulations, the following information is provided for the guidance of the user.

**WARNING:** This equipment has been tested and found to comply with the limits for Class B digital devices pursuant to Part 15 of the FCC Rules. These limits are designed to provide reasonable protection against harmful interference in a residential installation. This equipment generates, uses, and can radiate radio frequency energy and, if not installed and used in accordance with the instructions, may cause harmful interference to radio communications. However, there is no guarantee that interference will not occur in a particular installation. If this equipment does cause harmful interference to radio or television reception, which can be determined by turning the equipment off and on, the user is encouraged to try to correct the interference by one or more of the following measures:

- Reorient or relocate the receiving antenna.
- Increase the separation between the equipment and the receiver.
- Connect the equipment into an outlet on a circuit different from that to which the receiver is connected.
- Consult the dealer or an experienced radio/TV technician for help.

Changes or modifications to the digital device not expressly approved by Xircom Inc. could void the user's authority to operate the equipment.

It is suggested that only shielded and grounded cables be used with the equipment to ensure compliance with FCC rules.



## EUROPEAN COMMUNITY - CE MARK

### Declaration of Conformity

Xircom, Inc. declares that the equipment described in this document is in conformance with the requirements of the European Council Directive listed below:

89/336/EEC      EMC Directive

on the approximation of the laws of Member States relating to Electromagnetic Compatibility.

This declaration is based upon compliance of the product to the following standards:

EN 55022 (CISPR 22) RF Emissions Control

EN 50082-1 (IEC 801) Immunity to Electromagnetic Disturbance

Product Description: Xircom Pocket Ethernet Adapter III,  
Models PE3-10BT, PE3-10B2, and PE3-10BC

Authorized Signature:



R.W. Bass,

Vice President, Operations

Xircom, Inc.  
2300 Corporate Center Drive  
Thousand Oaks, California 91320  
U.S.A.

# INDEX

10BASE-2 2, 4, 10

10BASE-5 2, 4, 10

10BASE-T 2, 4, 10

## A

AC power adapter  
  installation 16  
  voltage requirements 7

Adapter Data 25

Adapter, Pocket Ethernet

  configuration 26

  data display 25

  description 1

  media interface 4

  models 1, 2

  network data 26

  parallel port 14

  power cautions 16

  specifications 4, 5

  transmit test 26

Artisoft LANtastic 27

AT&T StarLAN 10 2

AT&T/NCR StarGROUP 28

AUI cable 13

## B

Banyan VINES 30

Bidirectional mode 15

BNC connector 11

  T connector 4

## C

Cable fault indicator 19

Cabling, network 4, 10

CE Mark Declaration 92

Collision indicator 19

Combination installation 12

Combination unit 2, 4

Command line parameters 73

Configuration, adapter 26

Contents, package 9

Customer Support 81

## D

D-type connector 4

Data, Adapter 25

DEC PATHWORKS 31

Declaration of Conformity, CE  
  Mark 92

Diagnostics 5

  hardware 19, 25

  indicator

    lights 19, 21. *See also*

    Error messages

  self test 24

Disable link integrity checking 19

DOS drivers 22

## Drivers

- Artisoft LANtastic 27
- AT&T StarGROUP 28, 29
- Banyan VINES 30
- DEC PATHWORKS 31
- FTP Software LAN-Watch 34
- FTP Software PC/TCP 36
- HP LAN Manager. *See*  
Driver: Microsoft LAN  
Manager
- IBM LAN Requester 44
- IBM OS/2 Extended  
Services 41
- IBM OS/2 LAN  
Server 42, 45
- Microsoft LAN Man-  
ager 46
- Microsoft Windows 95 47
- Microsoft Windows for  
Workgroups 49
- Microsoft Windows NT 53
- NCR StarGROUP 28
- NCSA Telnet 54
- Novell NetWare 55, 57
- Novell NetWare Re-  
quester 59
- Novell Personal Net-  
Ware 61
- SunSelect PC-NFS 62
- Ungermann-Bass Net/  
One 63
- Wollongong PathWay  
Access 65

## E

- EEPROM test 25
- Enhanced parallel port
  - EPP BIOS 15
  - utility 15, 22
- Enhanced parallel port utility
  - DOS 23
  - OS/2 24
- EPP BIOS 15, 22
  - keyword 22
- Equipment required 10
- Error messages 67

## F

- FCC
  - certification 5
  - notice 91
- FTP Software LANWatch 34
- FTP Software PC/TCP 36
- FTP Software PC/TCP, Novell  
NetWare with 39

## H

- Hardware test 25
- HP LAN Manager. *See*  
Microsoft LAN Manager

## I

- IBM LAN Requester 42
- IBM LAN Server 43
- IBM OS/2 Extended Edi-  
tion 44
- IBM OS/2 Extended Ser-  
vices 41
- IBM OS/2 LAN Server 42
- Init test 25

Installation 12  
  10BASE-2 11  
  10BASE-5 13  
  10BASE-T 12  
  AC power adapter 16  
  cautions 11, 13  
  combination 12  
  phantom power cable 17  
  required equipment 10  
  thick Ethernet 13  
  thin Ethernet 11  
  twisted pair 12  
International notice 88  
Interrupt settings 26

**K**

Keyboard connector 17

**L**

LAN Manager  
  AT&T/NCR StarGROUP 28  
  HP. *See* Microsoft LAN  
  Manager  
  Microsoft 46  
  Ungermann-Bass Net/  
  One 63  
IAN Requester, IBM 42  
LAN Server, IBM 43, 45  
LANtastic, Artisoft 27  
LANWatch, FTP Software 34  
License agreement 89  
Local printer access 3

## **M**

Media interface 4  
Memory size 5  
Memory test 25  
Messages, error 67  
Microsoft LAN Manager 46  
Microsoft Windows 95 47  
Microsoft Windows for  
  Workgroups 49  
Model Numbers 2  
Model PE3-10BC  
  LINKDISABLE 20  
Model PE3-10BT  
  LINKDISABLE 20  
Models, Pocket Ethernet  
  Adapter 2  
Modes, parallel port 15  
Mouse/keyboard connec-  
  tor 17

## **N**

NCR StarGROUP. *See* AT&T/  
  NCR StarGROUP LAN  
  Manager  
NCSA Telnet 54

## NDIS driver

- Artisoft Lantastic 27
- AT&T StarGROUP 28
- Banyan VINES 30
- DEC PATHWORKS 31
- FTP Software LAN-Watch 35
- FTP Software PC/TCP 37
- HP LAN Manager. *See* Microsoft LAN Manager
- IBM LAN Requester 42
- IBM LAN Server 43
- IBM OS/2 Extended Services 41
- Microsoft LAN Manager 46
- Microsoft Windows 95 47
- Microsoft Windows for Workgroups 47, 49
- NCR StarGROUP. *See* AT&T/NCR StarGROUP
- SunSelect PC-NFS 62
- Ungermann-Bass Net/One 63
- Wollongong PathWay Access 65
- Net/One LAN Manager, Ungermann-Bass 63
- NetWare, Novell 39, 52, 55
- NetWare Requester for OS/2, Novell 59, 60
- NetWare server driver 57
- Network cabling 4, 10
- Network Drivers diskette 9

- Network link integrity checking and reporting, how 21. *See also* Command line parameters
- Network traffic graph 26
- NOEPP Keyword 22
- Non-bidirectional mode 15
- Novell
  - NetWare 39, 52, 55
  - Personal NetWare 61
  - SNA Gateway 57

## O

### ODI driver

- FTP Software PC/TCP 36, 38
- Microsoft Windows for Workgroups 47, 49, 52
- Novell NetWare 55, 57
- Novell Personal NetWare 61
- Operating temperature range 5
- OS/2. *See* IBM OS/2 LAN Server
- OS/2 Extended Services, IBM 41
- OS/2 LAN Server, IBM 42, 45

## P

- Package contents 9
- Packet driver
  - FTP Software LAN-Watch 34
  - FTP Software PC/TCP 36
  - NCSA Telnet 54
  - Novell NetWare 57

- Parallel port
    - attachment screws 14
    - connecting to 14
    - enhanced 15
    - multiplexor 3
    - performance 15
    - power cautions 16
  - Parallel port transfer
    - modes 26
  - Parameters
    - command line 73
    - NDIS driver 73
    - ODI driver 75
    - packet driver 78
  - Pass-through mouse connector 17
  - PathWay Access,
    - Wollongong 65
  - PATHWORKS, DEC 31
  - PC-NFS, SunSelect 62
  - PC/TCP, FTP Software 36
  - PE3TEST 19, 24, 69
  - Personal NetWare, Novell 61
  - Phantom power cable
    - cautions 6, 17
    - description 6, 9
    - installation 17
  - Pocket Ethernet Adapter 9
    - configuration 26
    - connecting to parallel port 14
    - data display 25
    - description 1
    - media interface specifications 4
    - models 2
    - network traffic graph 26
    - specifications 5
    - transmit test 26
  - Port settings 26
  - Power 6, 16
  - Power cable, phantom
    - cautions 6
    - description 6
    - installation 17
  - Power management 18
  - Power on indicator 19
  - Printer access 3
  - Product registration card 9
  - PS/2-style mouse/keyboard connector 17
- ## R
- README file, viewing 69
  - Registration card, product 9
  - Required equipment 10
  - RJ-45 connector 4, 10, 12
- ## S
- Size, Pocket Ethernet
    - Adapter 5
  - SNA Gateway, Novell 57
  - Software 89
    - Artisoft LANtastic 70
    - AT&T 70
    - DEC 70
    - description 2
    - FTP Software 71
    - LAN Manager DOS 70
    - LAN Manager OS/2 70
    - LANWatch OS2 71
    - license agreement 89
    - list of 69
    - NCR 70
    - NDIS 70
    - NetWare 71
    - ODI 71
    - operation 27
    - setup 27
    - Xircom DOS 70
    - Xircom OS/2 70

- Software License Agreement 89
- Specifications 5
  - AC power adapter 7
  - media interface 4
  - phantom power cable 6
- StarGROUP LAN Manager
  - AT&T/NCR 28
- StarLAN 10, AT&T 2, 21
- Storage temperature range 5
- SunSelect PC-NFS 62
- Support, Technical 81

## T

- T connector, BNC 4, 11
- Technical Support 81
- Telnet, NCSA 54
- Temperature range
  - operating 5
  - storage 5
- Terminator, 50-ohm 10, 11, 12
- Thick Ethernet installation 13
- Thin Ethernet installation 11
- Tractor grip 14, 16, 18
- Transfer rate 5
- Transmit test 26
- Twisted pair installation 12

## U

- Unauthorized applications 88
- Ungermann-Bass Net/
  - One 63
- Unshielded twisted pair networks 19

## V

- VINES, Banyan 30
- Voltage requirements, AC power adapter 7

## W

- Warranty service 86
- Warranty, Xircom 85
- Weight, Pocket Ethernet Adapter 5
- Windows 95 47
- Windows for Workgroups 47, 49
  - NDIS 2.0 driver 51
  - NDIS 3.0 driver 50
  - ODI driver 52
  - removing old installation 50
  - with NetWare 52
- Windows for Workgroups, Microsoft 49
- Windows NT, Microsoft 53
- Wollongong PathWay Access 65

## X

- Xircom telephone numbers 82

# **Xircom**

2300 Corporate Center Drive  
Thousand Oaks, California 91320-1420

(805) 376-9300  
(805) 376-9311 Fax

---

## **Xircom Europe NV**

King Square,  
De Villermontstraat 16  
2550 Kontich, Belgium

+32/(0)3 450.08.11  
+32/(0)3 450.09.90 Fax

## **Xircom Asia Pacific Ltd**

#13-03 Cecil Court  
138 Cecil Street  
Singapore 069538

+65 323 1511  
+65 224 3313 Fax