

---

**VIDEO  
SEVEN**

---

**VGA  
1024i**

User's  
Manual

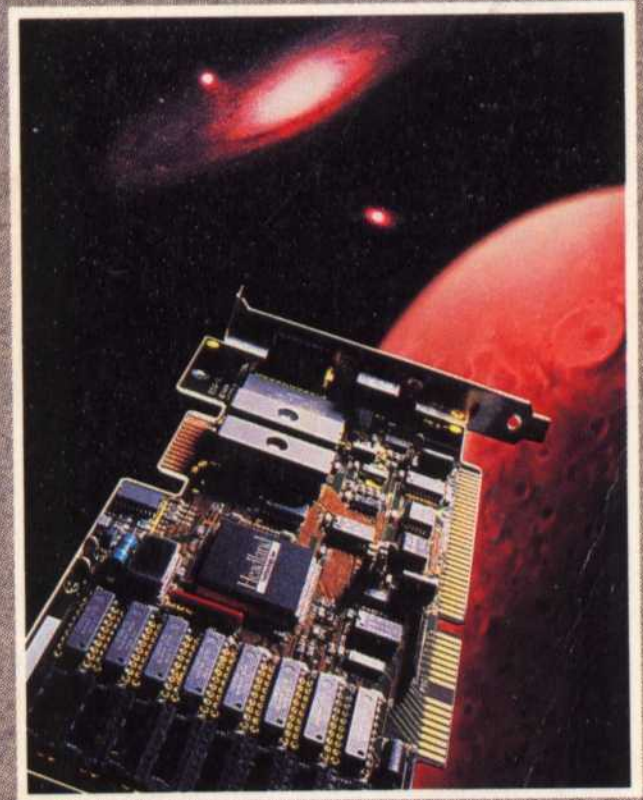

Best of Seven

# HEADLAND TECHNOLOGY INC.

reserves the right to make improvements in the product described in this manual  
at any time and without notice.

## FEDERAL COMMUNICATIONS COMMISSION RADIO FREQUENCY INTERFERENCE STATEMENT

NOTE: This equipment has been tested and found to comply with the limits for a Class B digital device, pursuant to Part 15 of the FCC Rules. These limits are designed to provide reasonable protection against harmful interference in a residential installation. This equipment generates, uses and can radiate radio frequency energy and, if not installed and used in accordance with the instructions, may cause harmful interference to radio communications. However, there is no guarantee that interference will not occur in a particular installation. If this equipment does cause harmful interference to radio or television reception, which can be determined by turning the equipment off and on, the user is encouraged to try to correct the interference by one or more of the following measures:

- Re-orient or relocate the receiving antenna.
- Increase the separation between the equipment and receiver.
- Connect the equipment into an outlet on a circuit different from that to which the receiver is connected.
- Consult the dealer or an experienced radio/TV technician for help.

NOTE: This device complies with Part 15 of the FCC Rules. Operation is subject to the following two conditions: (1) this device may not cause harmful interference, and (2) this device must accept any interference received, including interference that may cause undesired operation.

## MODIFICATIONS

Changes or modifications not expressly approved by Headland Technology Inc. could void the user's authority to operate the equipment.

## SHIELDED CABLES

Shielded cables must be used with this equipment to maintain compliance with the FCC regulations.

## TRADEMARK ACKNOWLEDGEMENTS

Video Seven and FastWrite are trademarks of Headland Technology Inc. All other brand and product names may be trademarks of their respective companies.

## COPYRIGHT NOTICE

This manual is copyrighted. All rights are reserved. This document may not, in whole or part, be copied, photocopied, reproduced, translated, or reduced to any electronic medium or machine readable form without prior consent, in writing, from Headland Technology Inc.

© 1989 by HEADLAND TECHNOLOGY INC.  
46221 Landing Parkway  
Fremont, CA 94538

Patent Pending

# **VIDEO SEVEN VGA 1024i USER'S MANUAL**

## **Table of Contents**

<b>Part 1 - Introduction</b>	<b>1</b>
Monitor Compatibility	2
Software Compatibility	2
About This Manual	3
If you're new to computers	4
If you have some computer experience	5
If you're experienced with computers	5
Optional Disk Format	5
Most Up-to-Date Information	5
<b>Part 2 - The VGA 1024i Installation</b>	<b>7</b>
What You Need	7
Prevent Static Electric Damage	8
Parts of the VGA 1024i	9
Preparing Your Computer	10
Configuring Your Computer	11
Installing the VGA 1024i in an Expansion Slot	14
Closing Your Computer	17
Additional Installation Instructions	18
PC/AT and Compatibles Owners	18
PS/2 and Compatibles Owners	18
MultiSync and Compatibles Owners	18
Memory Locations Used by the VGA 1024i	18
Special System Installation Instructions	19
The VGA 1024i Installation Program (INSTALL.COM)	21
Screen Saver	21
RAMBIOS.SYS	22
Running the VGA 1024i Installation Program	22
<b>Part 3 - The VGA 1024i Software</b>	<b>23</b>
RAMBIOS.SYS	24
The VGA 1024i Utility Program (V7VGA.COM)	26
V7VGA Menu Program	26
Compatibility Modes	27
CGA Compatibility	28
Hercules Compatibility	28
EGA Compatibility	29
Pure VGA Compatibility	29

Screen Saver	30
Screen Saver Commands and Their Functions	31
Using Screen Saver	31
When Software Does Not Work With Screen Saver	32
Multiple V7VGA.COM Commands	33
V7ANSI.SYS	33
Directory Listing Utility (DU.COM)	34
Enhanced Mode Clear Screen Utility (CLR.COM)	35
Enhancement Selection Utility (ESU.COM)	36
Diagnostics Program (V7DIAG.EXE)	37
Alternate Parameter Utility (ALTPARM.COM)	38
<b>Part 4 - Application Software</b>	<b>39</b>
Software Support	39
AutoCAD	42
GEM/3	49
Generic CADD Level 3	51
Lotus 1-2-3 and Symphony	51
P-CAD	53
Presentation Manager	54
Ventura Publisher	55
VersaCAD Design	55
Windows/286	57
Windows/386	58
WordPerfect	60
WordStar 3.3	61
WordStar Professional 4.0	62
<b>Appendix A - Built-In Video and Two Monitor Systems</b>	<b>A-1</b>
The VGA 1024i as the Secondary Adapter	A-2
<b>Appendix B - Switch and Jumper Settings</b>	<b>B-1</b>
Switch Settings	B-1
Jumper Settings	B-3
<b>Appendix C - V7VGA.COM Command Summary</b>	<b>C-1</b>
<b>Appendix D - Technical Information</b>	<b>D-1</b>
Monitor Specifications	D-1
Analog Display Pinouts	D-1

Feature Connector Pinouts	D-1
Monitor Timings for the VGA 1024i	
Extended Graphics Modes	D-2
Programmer's Information	D-3
Text and Graphics Modes	D-3
Sample Code Fragments	D-4
V7VGA Technical Reference Manual	D-5
Additional Resources	D-5
Upgrading to 512K	D-6
<b>Appendix E - Troubleshooting</b>	<b>E-1</b>
Hardware Troubleshooting	E-1
Software Troubleshooting	E-4
<b>Appendix F - Service and Technical Assistance</b>	<b>F-1</b>
Technical Support Bulletin Board Service	F-1
When You Call Technical Support	F-2
Before Shipping the VGA 1024i To Us	F-3
Software Compatibility Guarantee	F-4
<b>Appendix G - Glossary</b>	<b>G-1</b>
<b>Headland Technology Inc. Limited Warranty</b>	



# *Part 1*

---

## **INTRODUCTION**

The Video Seven™ VGA 1024i is one of the most advanced and innovative Super VGA adapters available. It provides speeds unequalled in a standard DRAM-based VGA and offers superior software compatibility.

The VGA 1024i supports both monochrome and color high resolution graphics and text modes on fixed- and variable-frequency analog monitors. It provides the standard VGA resolution of 640 x 480 and extended resolutions such as 800 x 600 with 16 colors in a non-interlaced mode, or 1024 x 768 with 16 colors in an interlaced mode.

Your new VGA 1024i comes with utility disks that have programs and drivers which enable you to get the maximum benefit from your VGA 1024i's enhanced capabilities. Included are a menu-driven installation program, high resolution drivers for software packages, and useful utility programs. This manual includes complete instructions for using the VGA 1024i utilities and the installation and use of high resolution drivers.

The VGA 1024i can be configured with either 256K or 512K of memory. You can upgrade a VGA 1024i configured with 256K to 512K. Details about the type of memory used in the upgrade are included in "*Appendix D - Technical Information / Upgrading to 512K.*"

## Monitor Compatibility

The VGA 1024i works properly with monitors compatible with the IBM PS/2 analog monitors. This includes both variable- and fixed-frequency analog monitors. Examples of variable-frequency monitors include the NEC MultiSync, Sony Multiscan, Mitsubishi DiamondScan and the Nanao Flexscan. Examples of fixed-frequency monitors include the IBM 8512 and 8513 and the Zenith 1490 Flatscreen.

The type of monitor you have may determine which of the VGA 1024i modes you can use. For example, the IBM 8514 monitor and some compatibles such as the Seiko CM-1430 will not run the 800 x 600 mode because it does not use the vertical/horizontal scan rates that the VGA 1024i requires. *"See Appendix D - Technical Information / Monitor Specifications."*

The NEC MultiSync 3D is capable of both the 800 x 600 and the 1024 x 768 modes. In fact, many of the MultiSync monitors will run both modes, however, there may be noticeable flicker in the 1024 x 768 modes because these monitors are primarily for use in non-interlaced modes.

If you have a system with built-in video or want more than one display adapter installed in your system, refer to *"Appendix A - Built-In Video or Two Monitor Systems."*

## Software Compatibility

The VGA 1024i is designed to work with software written for these video standards:

VGA	IBM Video Graphics Array
EGA	IBM Enhanced Graphics Adapter
CGA	IBM Color Graphics Adapter
MDA	IBM Monochrome Display Adapter
HGC	Hercules Graphics Card

Our software compatibility guarantee states that if it doesn't, we'll make it work or refund the purchase price. See *"Appendix F - Service and Technical Support"* for complete details of the guarantee.



# About This Manual

This manual is divided into four parts:

- ❑ **Part 1** is an introduction.
- ❑ **Part 2** tells you how to install the VGA 1024i. Instructions are included in three levels of detail to suit everyone from the new user to those experienced with computers.
- ❑ **Part 3** gives directions for using special utility programs included with the VGA 1024i.
- ❑ **Part 4** provides information for configuring your software and/or using application software drivers included on the VGA 1024i Utility Disks. All references to using the VGA 1024i Utility or Driver Disks appear in this manual in **bold type**. Programs addressed include:
  - ▼ AutoCAD
  - ▼ AutoShade
  - ▼ GEM/3  
(All applications that run under GEM will be displayed at the same resolution you chose for GEM.)
  - ▼ Generic CADD
  - ▼ Lotus 1-2-3 and Symphony
  - ▼ P-CAD
  - ▼ Presentation Manager
  - ▼ Ventura Publisher
  - ▼ VersaCAD Design
  - ▼ Windows/286 and Windows/386  
(All applications that run under Windows will be displayed at the same resolution you choose for Windows.)

- ▼ WordPerfect
- ▼ WordStar 3.3
- ▼ WordStar Professional

## ***Symbols and Conventions***

Symbols in this manual have these special meanings:

- ✱ indicates a **WARNING** or other important information
- ☞ draws your attention to important **NOTES**
- ✓ is followed by a **REMINDER**; something covered before or that you need to be sure to remember

## ***DOS Commands***

Instructions for entering DOS commands are shown in typewriter style with special keys (e.g. Enter) shown in brackets:

```
INSTALL <Enter>
```

## ***Overviews***

Many sections begin with an overview that looks like this:

OVERVIEW	
<input type="checkbox"/>	Each major section begins with a box which provides an overview of the information which follows

## ***If you're new to computers***

Use easy-to-follow, complete instructions for installation and software configuration.

### ***If you have some computer experience***

- Use the Overview at the beginning of each installation step for essential installation information.
- Complete installation, referring to detailed instructions for further clarification and information as needed.

### ***If you're experienced with computers***

- Use the "Quick Start Guide" to complete installation.
- Refer to overviews and detailed instructions if you need more information about a particular installation step.
- See appendices for additional technical information as desired.

## **Optional Disk Format**

The VGA 1024i is packaged with 5 1/4 inch floppy disks. If you require 3 1/2 inch disks you can request them from customer service via mail, telephone or fax. Additionally, the current utility software and drivers are always available for downloading from the Technical Support Bulletin Board. See "*Appendix F - Service and Technical Assistance*" for more information.

## **Most Up-to-Date Information**

The README file on the VGA 1024i Utility Disk may have additional information that became available after this manual was published. To check this information place the **VGA 1024i Utility Disk #1** in Drive A and type:

README <Enter>



## *Part 2*

---

### ***THE VGA 1024i INSTALLATION***

Your Video Seven VGA 1024i should install properly without any modifications being made to the switch or jumper settings. If it becomes necessary for you to adjust the switch settings, this can be accomplished from the back of the computer without having to remove the card. Complete descriptions of switch and jumper functions can be found in *"Appendix B - Switch and Jumper Settings."*

Toward the end of this section are specific installation instructions for certain types of computer systems.

#### **What You Need**

- Computer 100% compatible with IBM PC/XT/AT or PS/2 Model 30.
- Open 16-bit or 8-bit system expansion slot.
- MS-DOS or PC-DOS operating system, version 2.0 or later (for installation software).
- Medium flat blade screwdriver or nutdriver.

## **\* *Prevent Static Electric Damage***

Static can cause severe damage to microcircuits. There are some ways to minimize damage to the VGA 1024i and your computer.

- Handle the VGA 1024i by the edges only. Don't touch edge connectors or exposed circuitry.
- Leave the VGA 1024i in the anti-static protective bag until ready to install it in your computer.
- If possible, ground your body when handling the VGA 1024i. The metal power supply housing is generally considered the best place to ground yourself.
- Do not place the VGA 1024i on a metal surface.
- Make the least possible movement to avoid building up static electricity from your clothing, carpets and furniture.

## ***Parts of the VGA 1024i***

This drawing will help you identify the location of switches, jumpers, and connectors on your the VGA 1024i board.

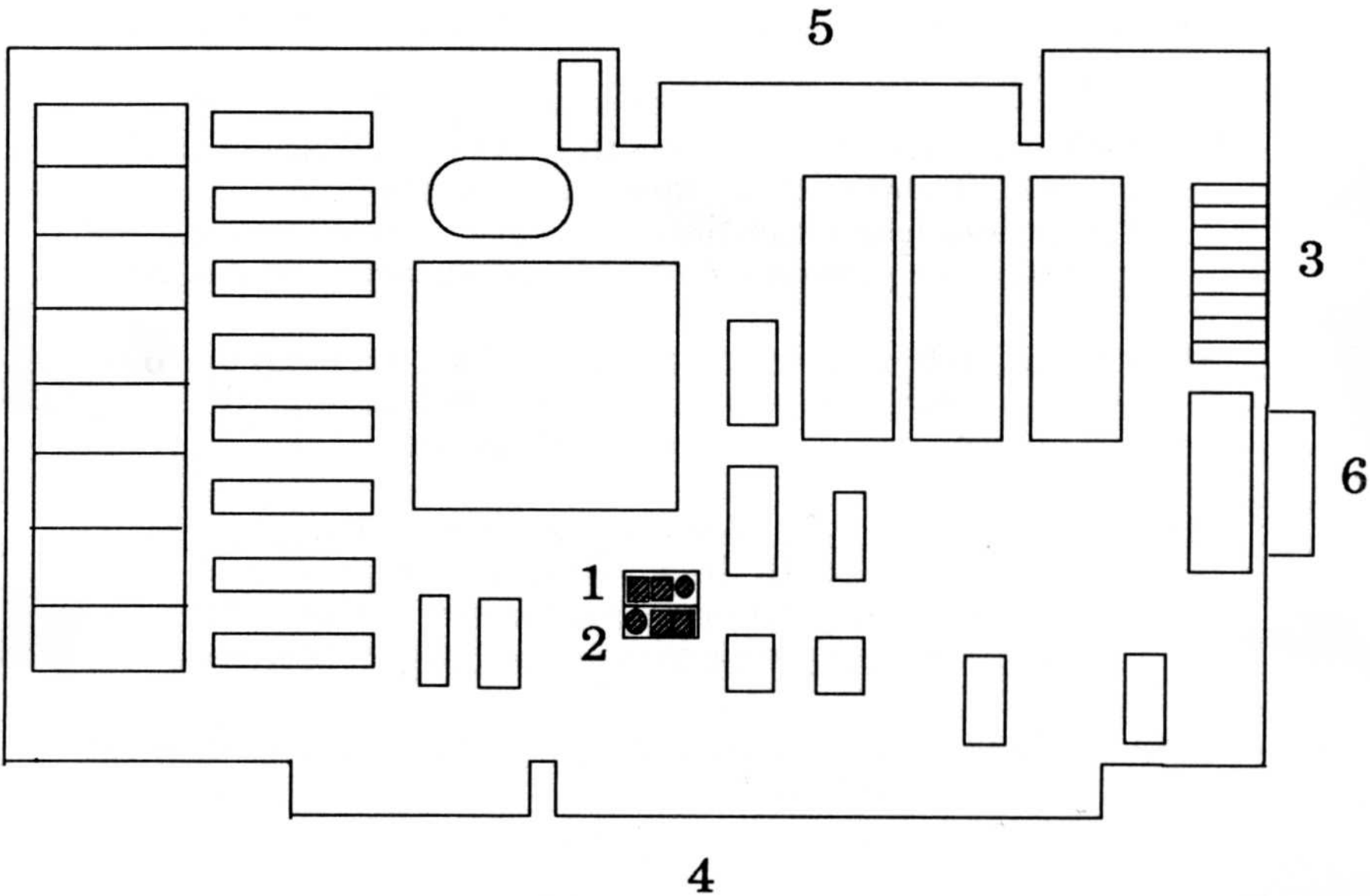

- 1: Jumper E1
- 2: Jumper E2
- 3: Switch Block
- 4: Expansion Slot Connector
- 5: VGA Feature Connector
- 6: Video Connector

# Preparing Your Computer

## OVERVIEW

- Turn off, then unplug computer and external options from electrical connections
- Remove cover mounting screws and slide cover off

 Drawings and instructions in this manual are of IBM PC/XT/AT computers. Most IBM compatible computers look essentially the same. Refer to your system user's guide for further information as needed.

**Step 1** Switch off your computer and all external options (printer, display, and others) and unplug all power cords from electrical source.

**Step 2** If necessary to remove your system cover, or for easier access to the back of your computer, disconnect peripheral equipment cables. Note cable positions for proper re-connection later.

**Step 3** Remove the cover-mounting screws and save them for reinstalling the cover.

 If the screws are not visible, your system unit may have a protective rear cover panel. It should pull right off. See your system manual to avoid damaging your computer.

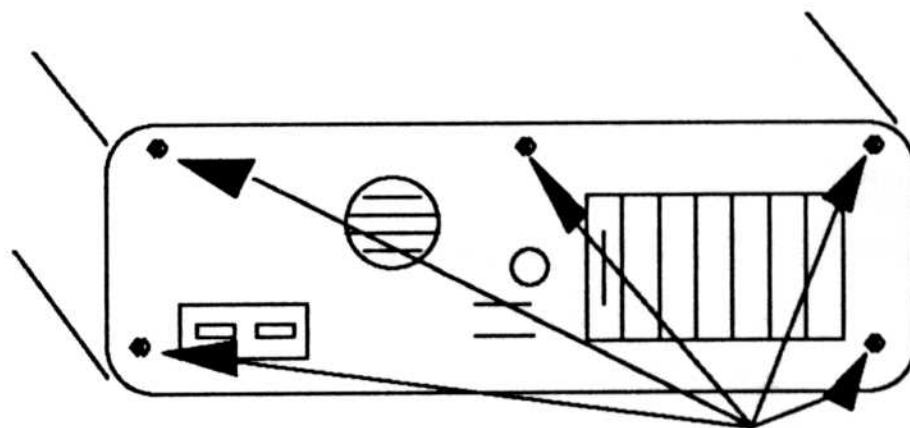

**Cover Mounting Screws**



**Step 4** Facing the front of the computer, hold onto both sides of the system cover. Slide the cover toward you. As the rear edge of the cover reaches the front of the PC, tilt the front of the cover upward, remove it and set it aside.

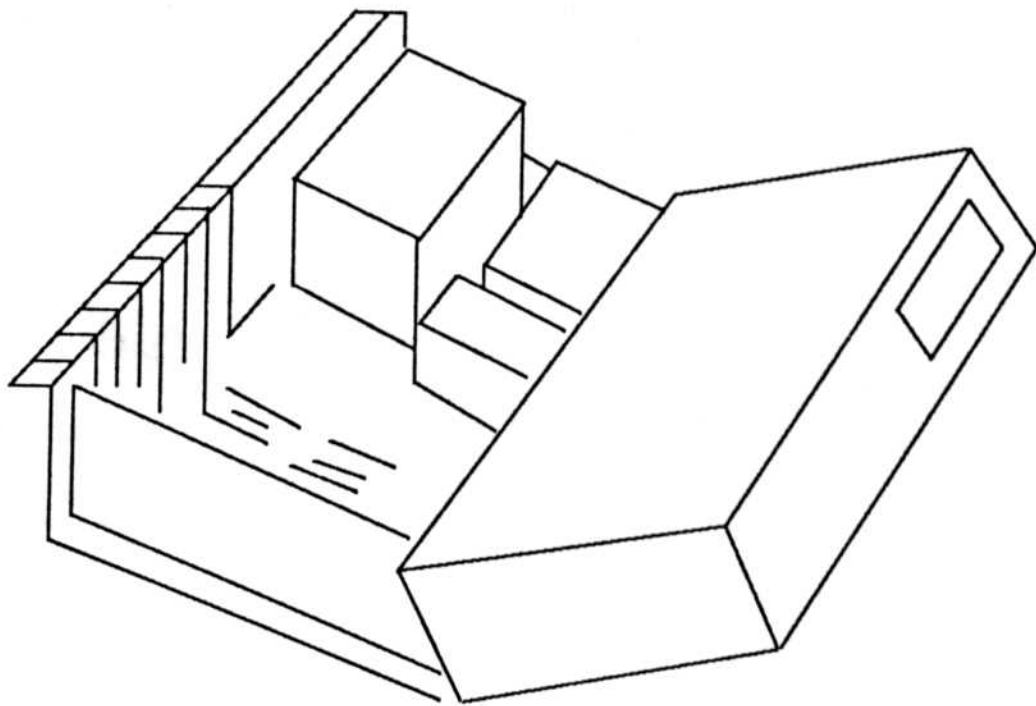

## Configuring Your Computer

### OVERVIEW

- If you have an IBM PC or PC/XT or compatible, set DIP Switch SW1, positions 5 and 6 to ON
- If you have an IBM AT or XT/286 or compatible, slide display adapter switch toward the front of your system unit. If you have an AT that does not have this switch, no action is necessary.

**Step 1** Locate system switches.

Use the drawings/descriptions that follow to locate the system switches. Switches are located on the motherboard (the base of the unit into which adapters are plugged) and the descriptions and drawings are from the perspective of looking toward the back wall of the computer case.

- ❑ The IBM PC has two switch blocks (either slide or rocker switches); one about six inches away from, and almost exactly perpendicular to, the keyboard connector and the other slightly to the left of the first.
- ❑ The IBM PC/XT has one switch block (either a slide or rocker switch) about six inches away from, and slightly to the left of, the keyboard connector.

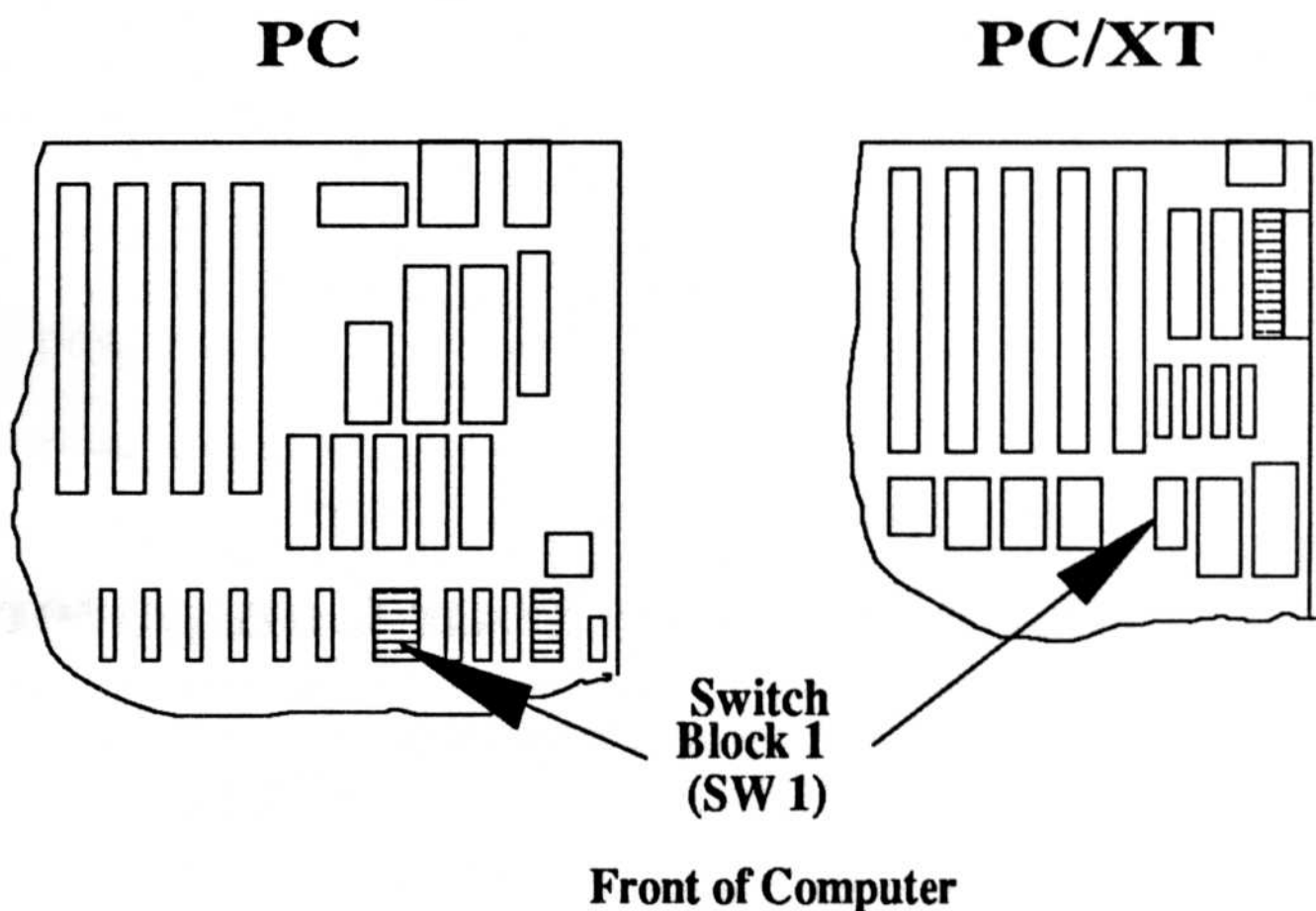

- ❑ The IBM AT and XT/286 or compatibles have a display adapter switch within a couple of inches and slightly to the right of the keyboard connector.
- ☞ Some early releases of the IBM AT do not have a display adapter switch. No action is required.

**Step 2** Set system switch.

- For an IBM PC/XT or compatible, set switch positions 5 and 6 to ON as shown below:

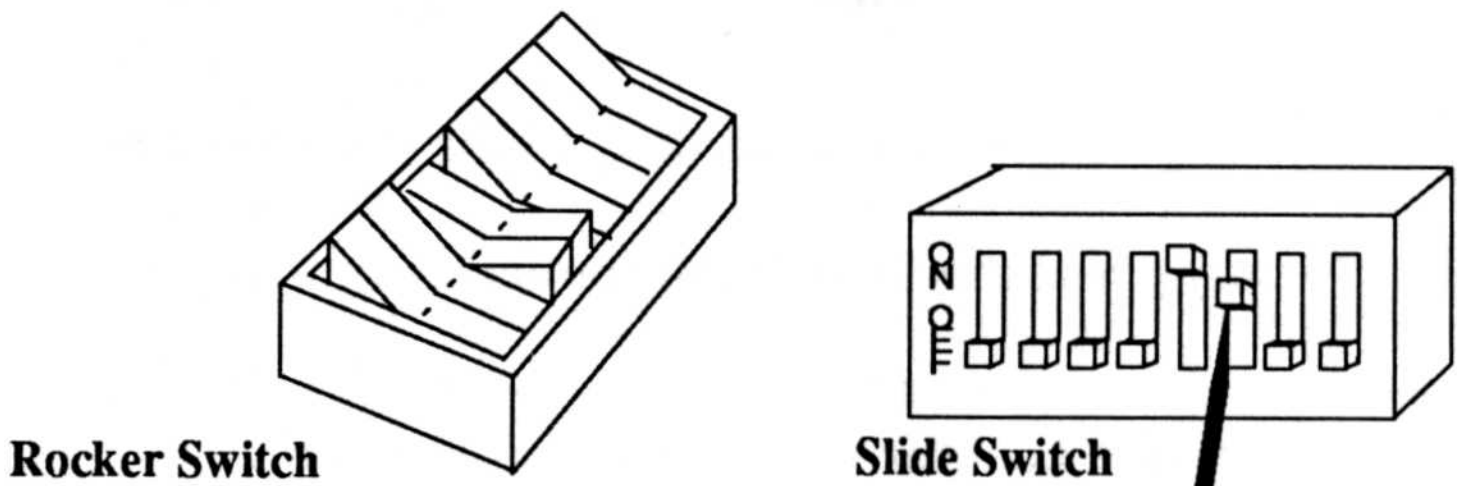

- For an IBM AT or XT/286 or compatible, slide the display adapter switch so that it is toward the front of the computer.

 The switch may already be in the forward position if there is/was a color graphics adapter installed.

**PC/AT**

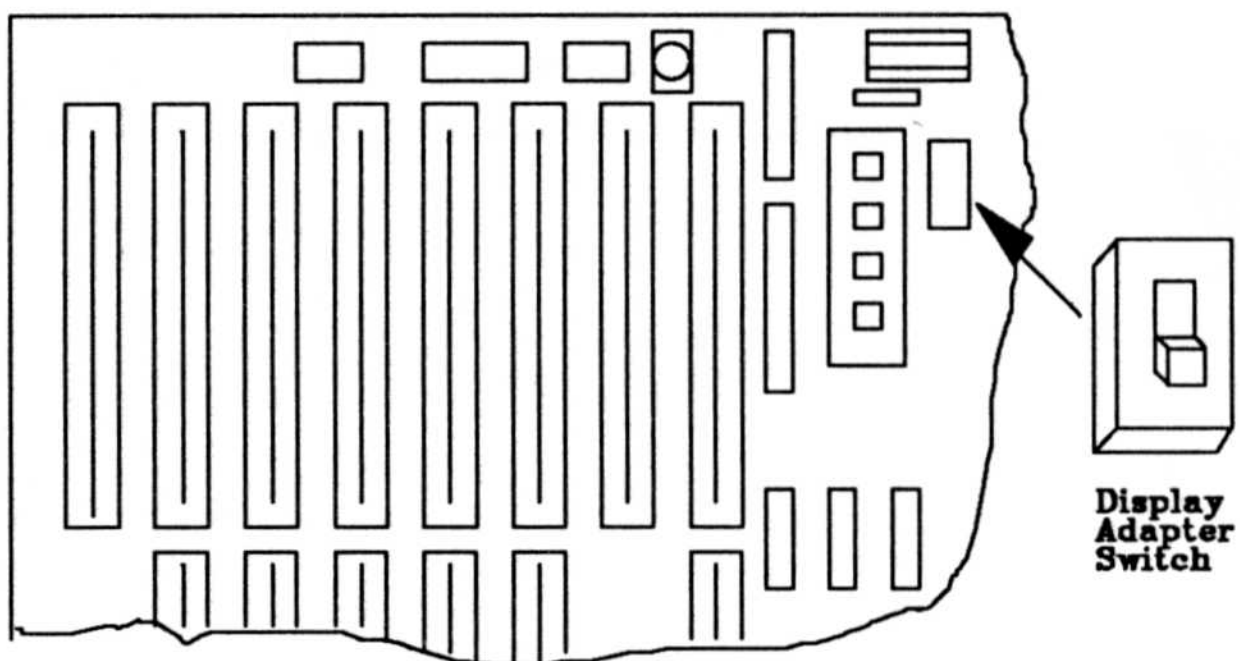

**Front of Computer**

## Installing the VGA 1024i in an Expansion Slot

### OVERVIEW

- Follow usual procedures to prevent static electric damage when handling the VGA 1024i
- Use any empty expansion slot, 16-bit slot works best
- Firmly press the VGA 1024i connector into expansion slot
- Secure the adapter with expansion slot screw

### \* *Important!*

- See "Prevent Static Electric Damage" on Page 8 for proper procedures in handling the VGA 1024i.
- If you have a system with built-in video or intend to have more than one display adapter installed in your system, refer to "*Appendix A - Built-In Video or Two Monitor Systems.*"

**Step 1** Default settings for switches and jumpers on the VGA 1024i are generally the best option for most systems. Should you have difficulties, you may want to try some different switch settings. Refer to "*Appendix B - Switch and Jumper Settings.*"

**Step 2** The VGA 1024i can be installed in any full-length, 8-bit or 16-bit expansion slot.

 For optimum performance, install the VGA 1024i in a 16-bit slot.

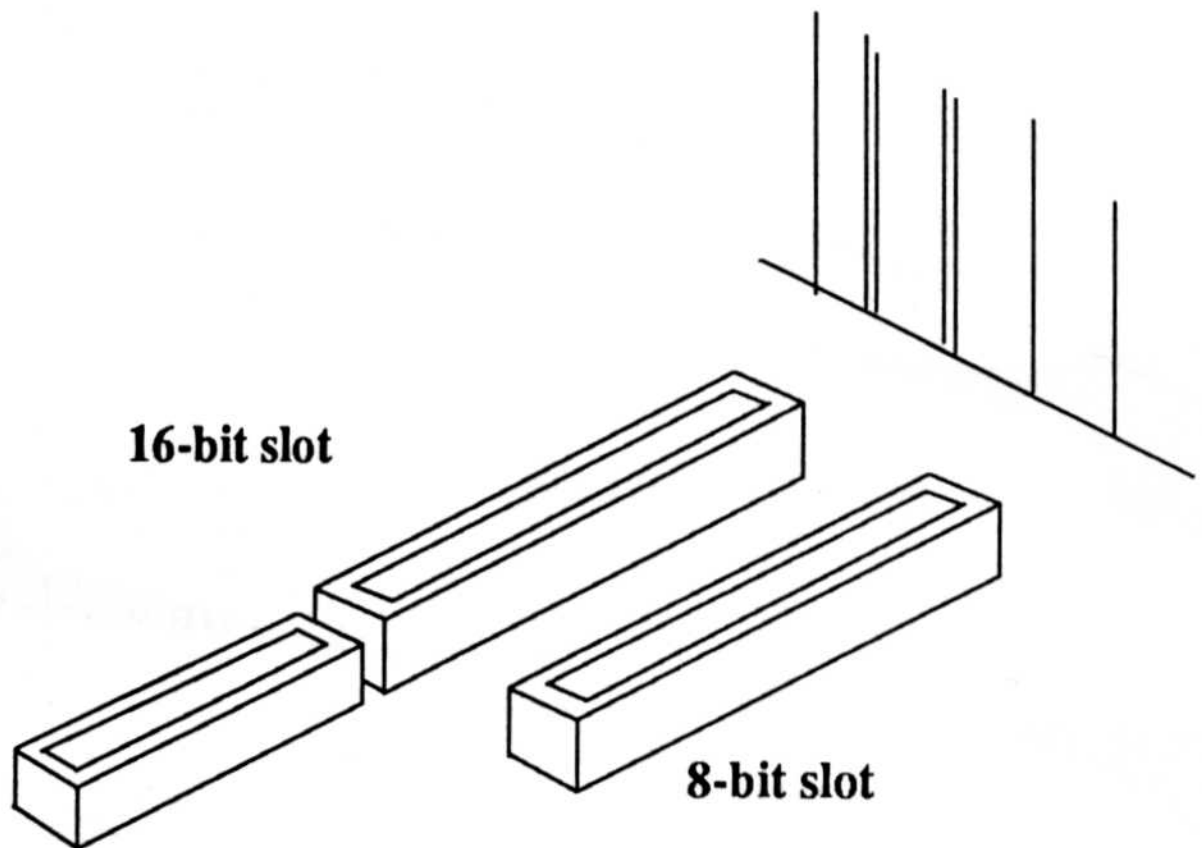

If the expansion slot still has the metal expansion slot cover attached, remove it with a screwdriver. Save the screw for installing the VGA 1024i.

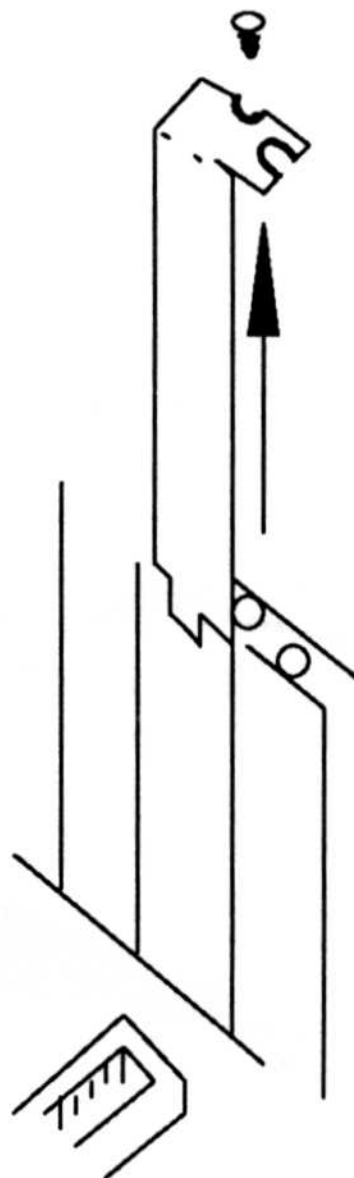

**Step 2** Hold the VGA 1024i by the edges and press the connector firmly into the expansion slot.

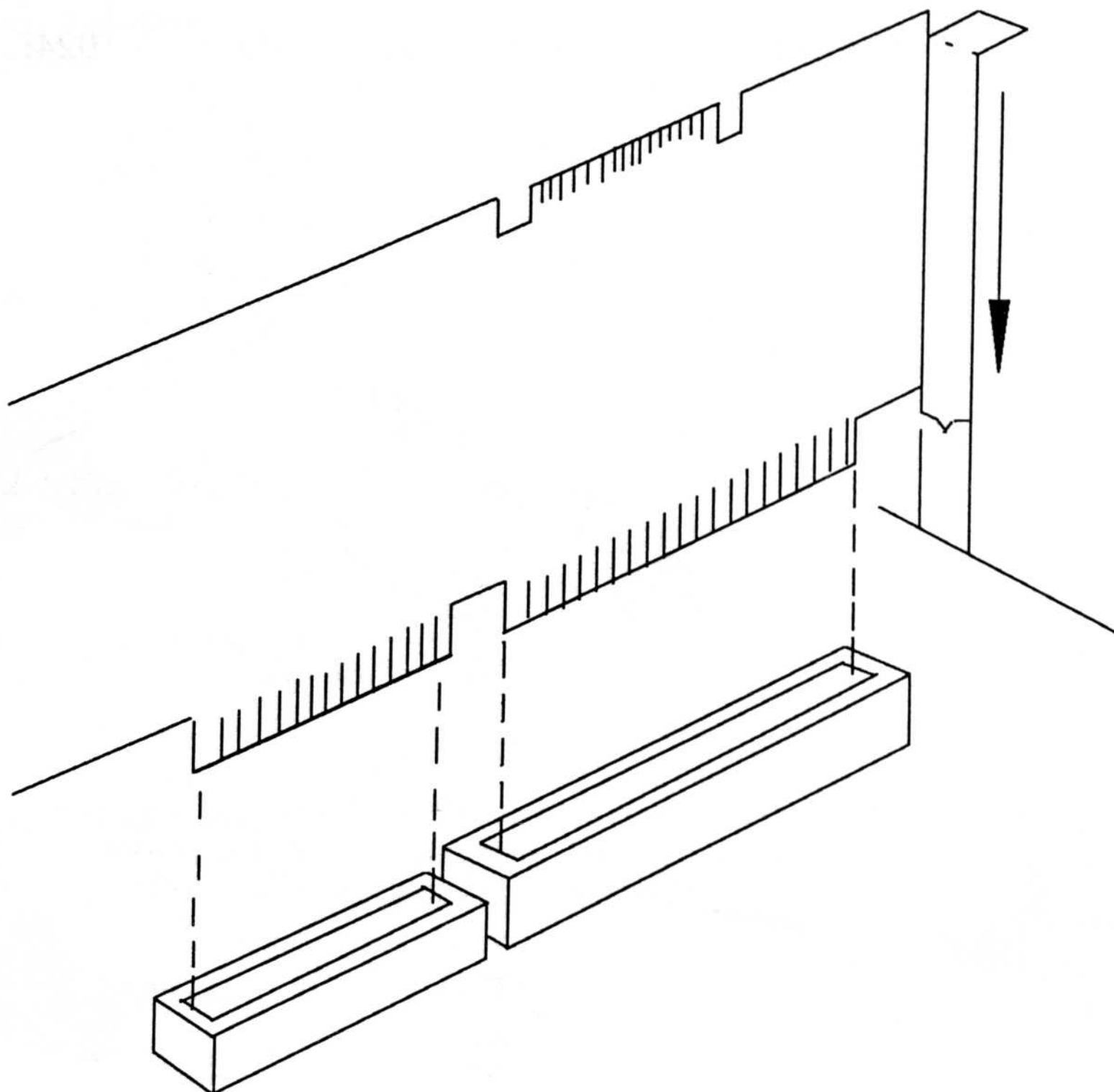

**Step 3** Align the slot in the mounting bracket of the VGA 1024i with the screw hole in the rear panel of the computer case.

Use the screw you removed from the expansion slot cover or previously installed video adapter to secure the VGA 1024i in place. *This step is important for proper grounding of the VGA 1024i.*

# Closing Your Computer

## OVERVIEW

- Close system unit in usual manner
- Reconnect external device cables
- Reconnect power to external devices and system unit

### *Before you close your computer*

- Review all installation steps for accurate completion.
- Properly set all switches.

**Step 1** Secure ribbon cables and gently push them down and out of the way before you replace the system cover.

**Step 2** Facing the front of the computer, hold onto both sides of the system cover, and slide the cover towards the rear of the system.

**Step 3** Align the cover mounting screws with the screw holes at the rear of the computer. Insert and tighten screws.

**Step 4** Reconnect any peripheral equipment cables you may have disconnected.

**Step 5** Securely attach your monitor cable to the VGA 1024i.

-  See "Appendix D - Technical Information" if you want more information on cable connectors.

# **Additional Installation Instructions**

## ***PC/AT and Compatibles Owners***

Run your computer's SETUP Program to complete installation. Answer questions of the SETUP program per your configuration. Check your manual to determine what is required for system setup. If there is a special "IBM EGA/VGA" option in the setup menu, choose this option. If your setup menu has options for "IBM EGA", "Other Display" or "No Display", try each setting to determine the proper configuration.

## ***PS/2 and Compatibles Owners***

Your monitor cable must be connected to the video connector on the VGA 1024i rather than the system board connector.

## ***MultiSync and Compatibles Owners***

Set your monitor to analog mode. You may be required to get a new cable or a 9- to 15-pin cable adapter. See your monitor owner's manual for further information. Set the "manual" switch located at the back of NEC MultiSync monitors to ON.

## ***Memory Locations Used by the VGA 1024i***

In its default configuration, the VGA 1024i uses memory locations A000 through C7FF for display memory and the extended video BIOS. The use of these memory locations is mandatory and cannot be modified. Conflicts can occur with devices (e.g. EMS Boards, Disk Controllers, Scanners) that can also use these locations. You should configure your device to use memory locations other than A000 through C7FF. Check with the manufacturer or your owner's manual for information about designating exclusions for these memory locations when invoking your device driver. The VGA 1024i can be alternately configured to use memory locations A000 to DFFF. See "Appendix B - Jumper Settings" for more information.



# Special System Installation Instructions

 The README file may have additional system information.

**AT&T 6300:** Some of the AT&T 6300 and 6300+ computers need the disabler chip COMCODE 405098625 to use any VGA or EGA card. Contact your AT&T dealer for information.

**Columbia 1600:** Must have Columbia BIOS ROM version 4.36 or later.

**Compaq Deskpro 386s:** Must disable onboard graphics.

**Compaq Portable 286:** Must switch onboard graphics to monochrome (Switch block 1, set Switch 7 OFF) and use an external monitor.

**Compaq Portable 386:** Must switch onboard graphics to monochrome (Set E-23 pins to 2 and 3) and use an external monitor.

**Dell 220:** Must disable onboard graphics.

**Epson Equity II:** Switch block #1 on the motherboard must have switches 5 and 6 ON.

**IBM PC:** Must have IBM BIOS ROM dated October 27, 1982 or later.

**IBM Portable:** Must disable onboard graphics and use an external monitor.

**IDS PC 8088-2:** Must have IDS BIOS ROM 3.86 or later.

**IDS PC 286 AT:** Must have IDS BIOS ROM 3.16 or later.

**ITT Extra:** Must have ITT BIOS ROM 2.0 or later.

**Kaypro 286 I:** Jumper #1 must be on pins 2 and 3.

**Leading Edge Model D:** Must disable onboard graphics by removing computer jumper connector on J10.

**Leading Edge Model M:** Must have Sperry ROM BIOS 4.71 or later.

**Mitsubishi 386:** Set the VGA 1024i jumper E2 to pins 2 and 3. If you have any other devices in your system using memory locations D000-DFFF you should also set the VGA 1024i switch 6 to OFF.

**Mylex:** Computer's EGA switch must be OFF.

**Sperry IT:** Select option "0" during setup. This selects "EGA." Although this option does not specifically appear, it will be accepted when entered.

**Sperry PC:** Must have Sperry ROM BIOS 4.71 or later.

**Tandy 1000 TL:** Must disable onboard graphics.

**Toshiba 2300:** Must disable onboard graphics and use an external monitor.

**Zenith 151/161:** Must disable onboard graphics.

**Zenith 158:** Must set computer switch 4 on SW301 to OFF. Set Switch 4 on SW202 to ON. Requires computer BIOS ROM 2.5 or later.

### ***After Installing the VGA 1024i***

Once the VGA 1024i is installed, each time you boot up your system a message similar to this one will appear:

```
VGA 1024i Bios  version X.xx
```

```
Copyright 1989, Headland Technology Inc.
```

The message above will not stay on your screen, but only flash by as additional AUTOEXEC.BAT or CONFIG.SYS commands are executed.

The VGA 1024i can be used with a hard or a floppy disk drive system. If you have correctly set and installed the VGA 1024i, the DOS prompt will appear on your monitor when you boot up your system. If your system does NOT boot up as you intended, check to see that the installation instructions were properly followed, or refer to "*Appendix E - Troubleshooting.*"

## **\* Back up the VGA 1024i Utility Disks!**

Before using the VGA 1024i Utility Disks, we strongly recommend that you make a backup copy and store the original disks in a safe place.

- ✓ For the greatest ease in using the VGA 1024i utilities, we suggest that you make a subdirectory for the VGA 1024i utility files. Copy the files from the VGA 1024i Utility Disks to this subdirectory. You may wish to include the subdirectory in a PATH command in your AUTOEXEC.BAT file.

## **The VGA 1024i Installation Program (INSTALL.COM)**

The Installation Program is menu-driven and lets you install Screen Saver and RAMBIOS.SYS for use with the VGA 1024i.

- ☞ Running INSTALL is optional and is not necessary for the operation of the VGA 1024i.

### ***Screen Saver***

Screen Saver "shuts off" your screen display if no key is pressed on your keyboard within some specified period of time. The Installation Program modifies or creates an AUTOEXEC.BAT file that will automatically invoke the Screen Saver feature with the default of 5 minutes.

- \* There are some instances when the use of Screen Saver is not recommended. Refer to "*Part Three - The VGA 1024i Software/Screen Saver*" for a complete description and directions for installing or modifying the installation of Screen Saver from the DOS prompt.

## ***RAMBIOS.SYS***

RAMBIOS.SYS is a device driver which allows you to install the VGA 1024i BIOS in memory (about 24K memory required) to enable programs that make extensive use of the video BIOS (e.g. dBase) to run faster. The Installation Program will create a CONFIG.SYS file if you do not have one, or will modify your existing file.

- \* RAMBIOS.SYS uses about 24K of memory. If you run software applications that require a lot of memory, use memory resident programs and/or have several drivers or "buffers" in your CONFIG.SYS file you may not want to install RAMBIOS. Refer to "*Part Three - The VGA 1024i Software / RAMBIOS.SYS*" for a complete description and the directions for installing RAMBIOS.SYS from the DOS prompt.

### ***Running the VGA 1024i Installation Program***

**Step 1** Make the Drive containing INSTALL.COM the current Drive/directory.

**Step 2** At the DOS prompt, type:

```
INSTALL <Enter>
```

**Step 3** If you wish to install Screen Saver now, choose "Set up the VGA 1024i Screen Saver" from the Installation Program Menu and continue to follow the menu instructions.

**Step 4** If you wish to install RAMBIOS.SYS now, choose "Install the VGA 1024i RAMBIOS Driver" from the Installation Program Menu and continue to follow menu instructions.

# *Part 3*

---

## ***THE VGA 1024i SOFTWARE***

This section includes detailed descriptions of several useful device drivers and utilities which make it possible for you to take full advantage of the extended capabilities of the VGA 1024i. These programs are on the **VGA 1024i Utility Disk #1**. Utility programs include:

- ROMDATE.COM** - checks your system ROM date. It should be 10/27/82 or later.
- RAMBIOS.SYS** - enables programs that use the video BIOS extensively to run faster.
- V7VGA.COM** - the VGA 1024i Utility Program - allows you to set Screen Saver options and set compatibility modes.
- V7ANSI.SYS** - can be used instead of the DOS ANSI.SYS device driver (which only works with standard text modes) to provide support for both extended and standard text modes.
- DU.COM** - Directory Listing Utility - displays directory information in as many columns as can be accommodated on the screen in the selected mode.

- ❑ **CLR.COM** - Clear Screen Utility - is used to clear the entire screen when you are using extended text modes.
- ❑ **ESU.COM** - Enhancement Selection Utility - allows you to set text and graphics modes. It features a menu driven program for setting text modes.
- ❑ **V7DIAG.EXE** - Diagnostics Program - helps you spot problems that may occur with the VGA 1024i.
- ❑ **ALTPARM.COM** - Alternate Display Parameter Utility - provides display parameters in addition to those included in the VGA 1024i BIOS.

## **RAMBIOS.SYS**

RAMBIOS.SYS allows you to install the VGA 1024i BIOS in memory (about 24K memory required) to enable programs that use the video BIOS extensively to run faster.

RAMBIOS.SYS can be installed either by using the VGA 1024i Installation Program (INSTALL.COM) or directly from the DOS prompt. INSTALL creates or modifies an existing CONFIG.SYS file and adds RAMBIOS.SYS as the first line.

- ✱ RAMBIOS.SYS uses about 24K of memory. If you run software applications that require a lot of memory, use memory resident programs and/or have several drivers or "buffers" in your CONFIG.SYS file you may experience some difficulties. Removing RAMBIOS.SYS from your CONFIG.SYS file may solve the problem by "freeing up" the 24K of memory. Refer to your DOS Manual if you need instructions for doing this.

## ***Installation from DOS Prompt with Hard Disk***

- Step 1** Copy the file "RAMBIOS.SYS" from the **VGA 1024i Utility Disk #1** into the root directory on your hard disk.
- Step 2** Create or modify your CONFIG.SYS file by adding the following statement. We recommend you add it as the first line of the file:

```
DEVICE=[path]RAMBIOS.SYS
```

- ✓ Refer to your DOS Manual if you need instructions for creating/editing a CONFIG.SYS file.
- Step 3** Reboot your computer for the change to take effect.

## ***Installation from DOS Prompt with Floppy Drive***

- Step 1** Insert the **VGA 1024i Utility Disk #1** in Drive A.
- Step 2** Insert your DOS boot-up disk into Drive B.
- Step 3** Copy the file RAMBIOS.SYS from the **VGA 1024i Utility Disk #1** onto your DOS boot-up disk.
- Step 4** Create or modify your CONFIG.SYS file by adding the following statement. We recommend you add it as the first line of the file:

```
DEVICE=A:\RAMBIOS.SYS
```

- ✓ Refer to your DOS Manual if you need instructions for creating/editing a CONFIG.SYS file.
- Step 5** Reboot your computer for the change to take effect.

# The VGA 1024i Utility Program (V7VGA.COM)

With the VGA 1024i Utility program, V7VGA.COM, you can set:

- Compatibility modes.
- Screen Saver options.

You can run V7VGA.COM programs:

- With the V7VGA Utility Menu Program.
- By entering a command at the DOS prompt.

## ***V7VGA Menu Program***

**Step 1** Make the Drive with V7VGA.COM the current Drive/directory.

**Step 2** At the DOS prompt, type:

V7VGA <Enter>

**Step 3** Follow the instructions on the screen to complete the procedure and to return to the menu.

-  In order to make proper choices in the Menu Program, see below for complete information on Compatibility Modes and Screen Saver options.

## ***Running V7VGA.COM from the DOS Prompt***

V7VGA.COM can be used with a hard or floppy disk drive system. To run the program:

**Step 1** Make the Drive with V7VGA.COM the current Drive/directory.



**Step 2** At the DOS prompt, type:

```
V7VGA [mode command] <Enter>
```

 "Appendix C - Summary of V7VGA.COM Commands" lists all the commands covered on the following pages.

## ***Compatibility Modes***

The VGA 1024i will run most programs written for any of the popular graphics standards: VGA, EGA, CGA, MDA, and HGC.

V7VGA compatibility modes are needed for programs that make direct access to the Color Graphics Adapter (CGA) or Hercules Graphics Card (HGC) registers. You should try running your program first without using a V7VGA compatibility mode. A compatibility mode may be necessary if:

- A program that works with a CGA or HGC fails to work properly on the VGA 1024i.
- A program's documentation specifically states that the program needs a CGA or HGC.

With the exception of HGC compatible software, most programs written since the introduction of EGA do not require the compatibility modes because they do not make direct access to the CGA registers.

You can enable or disable a compatibility mode:

- By entering a command at the DOS prompt or from within a batch file.
- With the V7VGA Utility Menu program.

## ***CGA Compatibility***

In order to run CGA-specific programs, CGA compatibility mode must be turned on with the V7VGA.COM program. You will know that you are in compatibility mode because the VGA 1024i uses a different text font when emulating CGA. Running a program which accesses a mode not available on the CGA will automatically switch you back into VGA mode. Before running another CGA program, you must again use the V7VGA utility program to re-enable CGA compatibility mode.

V7VGA CGA:ON	Configures the VGA 1024i for CGA compatibility.
V7VGA CGA:OFF	Disables a current configuration for CGA compatibility.

## ***Hercules Compatibility***

Hercules Compatibility Mode, or Monochrome Mode, allows you to configure the VGA 1024i to emulate the Hercules Graphics Card (HGC).

The HGC has 64K of video graphics memory. The VGA 1024i can run software written to utilize the graphics capabilities of the Hercules Graphics Card in two ways:

- FULL mode, configured to use the full amount of memory (two graphics pages, or 64K).
- HALF mode, configured to use half that amount (one graphics page, or 32K) of memory. Use this mode if you have a CGA co-resident.

✱ When the VGA 1024i is configured for HGC compatibility it must be connected to the IBM 8503, VFD or AD compatible.

In MONO:HALF mode the VGA 1024i must be connected to an IBM 8503 , VFD or AD compatible. A co-resident IBM-compatible CGA must be attached to an appropriate monitor.

While in HGC compatibility mode, the VGA 1024i will automatically switch into VGA mode if a mode is accessed which is not available on the HGC. Before running another Hercules program, you must again use the V7VGA Utility Program to re-enable HGC compatibility mode.

- V7VGA MONO:ON      Configures the VGA 1024i for HGC compatibility.
- V7VGA MONO:OFF    Disables a current configuration for HGC compatibility.
- V7VGA MONO:FULL   Configures the VGA 1024i for full 64K (two-page) HGC compatibility. The VGA 1024i becomes fully Hercules compatible and cannot have a co-resident IBM-compatible CGA board. (This command functions the same as "MONO:ON.")
- V7VGA MONO:HALF   Configures the VGA 1024i for 32K, (one-page) half HGC compatibility. Use this configuration if you have an IBM-compatible CGA in your system.

### ***EGA Compatibility***

The VGA 1024i is fully BIOS compatible with EGA. Because EGA and VGA are very closely related at the hardware level, BIOS-level compatibility enables virtually all EGA software to run without problems. Should you experience difficulties, you should contact the software manufacturer to see if their software package requires an update to work properly on a VGA.

### ***Pure VGA Compatibility***

The VGA 1024i BIOS implements many extended functions beyond standard VGA. Sometimes, a software application may not function properly if it detects these extended functions. In even fewer circumstances, a software application may respond unpredictably to any extended functions beyond those specified by the IBM standard for VGA.

V7VGA PURE:ON	Configures the VGA 1024i for only pure IBM VGA standard modes -- disables all the VGA 1024i extended modes.
V7VGA PURE:OFF	Enables all the VGA 1024i extended functions.

## ***Screen Saver***

Screen Saver can extend the life of your monitor by preventing images from being "burned" into your screen due to long periods of inactivity such as when you are away from your computer.

Screen Saver "shuts off" your screen display if no key is pressed on your keyboard for some period of time. (The default setting for time elapsed is five minutes.)

Generally, your screen display is returned by pressing any key on your keyboard. Pressing the "NUM LOCK" key is thought to be one of the best choices because this key usually has little or no effect on a program in progress.

 Because Screen Saver relies on signals from the keyboard, it is generally not recommended to activate Screen Saver if you will use:

- A mouse and not be using the keyboard regularly.
- Microsoft Windows.
- Games or other software with which you use a joystick (e.g. Flight Simulator).
- Software that causes the screen to "shut off" even when you are using the keyboard.

Refer to "*When Software Does Not Work With Screen Saver*" in this section for more information.

You may alter the Time-out Value -- the length of time elapsed before Screen Saver "shuts off" your screen display -- if you use software that combines the use of a pointing device and the keyboard.

### ***Screen Saver Commands and Their Functions***

- |                |  |
|----------------|--|
| V7VGA SAVE:ON  | Enables Screen Saver feature -- turns off the screen when there has been no keyboard activity for 5 minutes.                                   |
| V7VGA SAVE:[n] | Enables you to change the number of minutes before Screen Saver turns off the display. The letter "n" represents any number of minutes [1-99]. |
| V7VGA SAVE:OFF | Disables Screen Saver.   |
| V7VGA NOSAVE   | Disables Screen Saver.   |

### ***Using Screen Saver***

**Step 1** Make the Drive with V7VGA.COM the current Drive/directory.

**Step 2** At the DOS prompt, to:

- Enable the Screen Saver feature, type:

V7VGA SAVE:ON <Enter>

- Change the number of minutes before Screen Saver turns off the display, type the following command substituting the number of minutes you want for [n]:

V7VGA SAVE:[n] <Enter>

- Disable Screen Saver, type:

V7VGA SAVE:OFF <Enter>

or

V7VGA NOSAVE <Enter>

### ***When Software Does Not Work With Screen Saver***

The Screen Saver feature will not work correctly with software that doesn't pass on your keystrokes properly. You will know this is a problem if:

- The screen goes blank while you are using the keyboard.
- Striking a key does not return an image to your screen after it has gone blank.

If either of these symptoms occur, try:

- Restoring the screen by hitting the "NUM LOCK" key.
- Exiting your program "blind" by using the normal sequence. This allows you to save the work you have done and return to DOS.
- Rebooting your machine.

After regaining the screen via one of the above options, disable Screen Saver and resume using your program.

### ***Important Points***

- To deactivate Screen Saver once it is activated during boot up by your AUTOEXEC.BAT file, type:

V7VGA SAVE:OFF <Enter>

- To stop Screen Saver from being automatically enabled at startup, delete "V7VGA SAVE:ON" from your AUTOEXEC.BAT file and reboot your system.

- ❑ To automatically disable Screen Saver when you use a program that doesn't work with Screen Saver, use a batch file to invoke the program and include "V7VGA SAVE:OFF" or "V7VGA NOSAVE."
- ✓ Refer to your DOS Manual if you need instructions for creating/editing a batch file.

## ***Multiple V7VGA.COM Commands***

You can save time by combining the Utility Program commands on one line (up to 80 characters). For example, if you want to configure the VGA 1024i to emulate CGA and set the Screen Saver feature for a 15 minute delay, type:

```
V7VGA CGA:ON SAVE:15 <Enter>
```

## **V7ANSI.SYS**

V7ANSI.SYS is a device driver that provides support for extended as well as standard text modes. The DOS ANSI.SYS device driver only works with standard text modes (40 x 25 and 80 x 25). Refer to your DOS manual for information on the uses of ANSI.SYS.

### ***Using V7ANSI.SYS***

- \* If your CONFIG.SYS file includes the command "DEVICE = [path]ANSI.SYS," you must remove it when adding V7ANSI.SYS.

**Step 1** Copy the file "V7ANSI.SYS" from the **VGA 1024i Utility Disk #1** onto your hard disk.

**Step 2** Create/modify your CONFIG.SYS file by adding the following to the file:

```
DEVICE=[path]V7ANSI.SYS
```

**Step 3** Reboot your computer for the change to take effect.

# Directory Listing Utility (DU.COM)

The Directory Listing Utility takes full advantage of the screen by displaying directory information in as many columns as can be accommodated. It can be used in any mode and can display from 50 to 129 entries at a time as opposed to the 25 entries available through the DOS "DIR" command.

**Step 1** Copy the file "DU.COM" from the **VGA 1024i Utility Disk #1** onto your hard disk.

- ✓ You may wish to include the directory in the search path if you place DU.COM in other than your root directory.

**Step 2** At the DOS prompt, to display a list of:

- All files in the current directory, type:

```
DU <Enter>
```

- All files in a directory other than the current directory, specify the full DOS directory name and use wildcards as in these examples:

```
DU \MYFILE\*.* <Enter>
```

```
DU \MYFILE\LETTERS\*.* <Enter>
```

- Only certain files in a directory, specify multiple search strings on the command line by including the file names (wildcards may be included) and/or extensions as in these examples:

```
DU letter.* ltr*.txt <Enter>
```

```
DU \MYFILE\*.exe *.com <Enter>
```



- Only sub-directories, use the option /d on the command line like this:

DU/d <Enter>

- Files including hidden files, use the option /h on the command line like this:

DU/h <Enter>

- Files including system files, use the option /s on the command line like this:

DU/s <Enter>

 You can:

- STOP** the display with <Esc>
- PAUSE** the display with any key except <Esc>

## **Enhanced Mode Clear Screen Utility (CLR.COM)**

The Enhanced Mode Clear Screen Utility clears the entire screen in any text mode. Enhanced modes display information on as much of the screen as possible for the mode chosen. The DOS command, CLS, only clears the portion of the screen used by standard modes. To clear the entire screen in any text mode, type:

CLR <Enter>

# Enhancement Selection Utility (ESU.COM)

The Enhancement Selection Utility allows you to change text and graphics modes easily.

- ✿ Do not attempt to set a text or graphics mode that your monitor is not capable of supporting. See *"Appendix D - Technical Information / Programmer's Information"* for monitor requirements.

## ***Setting Text Modes with the ESU Menu***

**Step 1** Make the Drive containing ESU.COM the current Drive/directory.

**Step 2** At the DOS prompt, type:

```
ESU <Enter>
```

**Step 3** Use the up and down arrow keys to choose the text mode you want from the list that appears on the screen.

## ***Setting Text and Graphics Modes from the DOS Prompt***

**Step 1** Make the Drive containing ESU.COM the current Drive/directory.

**Step 2** At the DOS prompt, type:

```
ESU / [mode number] <Enter>
```

- ☞ See *"Appendix D - Technical Information / Programmer's Information"* for list of Text and Graphics Modes.

## Diagnosics Program (V7DIAG.EXE)

The Diagnosics Program will help you spot problems that may occur with your display adapter. The program is run from the DOS prompt by typing:

```
V7DIAG <Enter>
```

First, the Diagnosics program will display:

- The VGA 1024i BIOS date/version.
- Switch settings.
- Amount of video memory available on the VGA 1024i.
- Co-resident (if installed) graphics adapter.

Next, the Diagnosics program will display a series of self-explanatory screens demonstrating and testing various attributes and capabilities of the VGA 1024i.

-  If the Diagnosics program indicates a problem or if any of the screens appear incorrect, refer to *"Appendix E - Troubleshooting,"* then run the Diagnosics program again.

# Alternate Parameter Utility (ALTPARM.COM)

The Alternate Parameter Utility, ALTPARM.COM, is a memory-resident program that provides parameters for various monitors to improve the display in extended graphics modes.

Use ALTPARM if changing graphics mode causes your screen to shift or dramatically change size (e.g. your screen size "shrinks").

For a list of monitor parameters available, at the DOS prompt type:

```
ALTPARM <Enter>
```

If your monitor is listed, load the parameters for your monitor by typing:

```
ALTPARM [monitor name] <Enter>
```

 Even if your monitor is not listed, experimenting with the available options may improve your display as some monitor parameters are very similar.

To modify an existing setting, type:

```
ALTPARM SETUP <Enter>
```

This option allows you to select a monitor, choose a particular resolution, then modify the screen size and save the modified version to a user defined file.

To load a user defined parameter table type:

```
ALTPARM USER [filename] <Enter>
```

ALTPARM must be loaded every time you turn on your computer or you perform a warm boot. For ease of use, it is recommended you place the ALTPARM command line in your AUTOEXEC.BAT file.

# *Part 4*

---

## ***APPLICATION SOFTWARE***

The capabilities of the VGA 1024i go beyond the VGA standard. To use the VGA 1024i extended modes, your software must have the capability to run in the text or graphics mode you choose. Support must be provided in the software through the use of drivers to allow you to choose the VGA 1024i's extended graphics resolutions or text modes and colors.

### **Software Support**

The VGA 1024i is packaged with software support for several popular software programs. The VGA 1024i is compatible with the VESA (Video Electronics Standards Association) standard for the 800 x 600 16 color mode. If your software has a "VESA driver" you can select it to use this mode. Additionally, if your software supplies drivers for another Video Seven VGA board (such as the VEGA VGA), these drivers may work with the VGA 1024i. This section describes the procedures necessary to configure these programs and/or install special drivers to give you the best performance from your software.

Software drivers are located on the VGA 1024i Utility and Driver Disks as follows:

**Utility Disk #1**

- ▼ Lotus 1-2-3 versions 2.x and Symphony
- ▼ Windows/286 versions 2.x 16-color modes

**Utility Disk #2**

- ▼ GEM/3 versions 3.1 and 3.0
- ▼ Ventura Publisher versions 1.x and 2.0
- ▼ Windows/286 versions 2.x 256-color modes
- ▼ WordPerfect 5.0

**Windows/386 Disk**

- ▼ Windows/386 versions 2.x

**Presentation Manager Disk**

- ▼ Presentation Manager 1.1

**CAD Programs Disk**

- ▼ AutoCAD Release 9 and 10
- ▼ AutoShade
- ▼ Generic CADD Level 3
- ▼ P-CAD versions 3.0 and 4.0
- ▼ VersaCAD Design versions 5.3 and 5.4

Additionally, instructions are included for using extended text modes with:

- ▼ Lotus 1-2-3 versions 2.x and Symphony
- ▼ WordPerfect versions 4.2 and 5.0
- ▼ WordStar 3.3
- ▼ WordStar Professional 4.0

- ☞ The list of software drivers is constantly changing. Be sure to check the README files on the Utility and Driver Disks for the most current information. Also, new drivers and beta drivers are put on the Technical Support Bulletin Board as they become available. See "*Appendix F - Service and Technical Assistance*" for information on how to access the BBS.

## ✱ ***Before You Begin***

- ☐ To avoid damage to your monitor and other parts of your computer system, be sure you have correctly installed the VGA 1024i before you attempt to configure the software as described in this section.
- ☐ Graphics resolutions beyond 640 x 480 are not supported on fixed-frequency analog displays such as the IBM 8513 or the Zenith ZCM-1490.
- ☐ Extended graphics resolutions have minimum monitor scan frequency requirements:
  - ▼ 800 x 600 non-interlaced resolution requires a Variable Frequency Display such as the NEC MultiSync or Sony Multiscan.
  - ▼ 1024 x 786 interlaced resolution requires an Interlaced Display such as the NEC MultiSync 3D or the Seiko CM-1430.
- ☞ Not all monitors capable of displaying the 1024 x 768 interlaced resolution are capable of displaying the 800 x 600 resolution. See "*Appendix D - Technical Information / Monitor Timings for the VGA 1024i Extended Graphics Modes*" for information on scan frequency requirements.
- ☐ You may have to adjust the horizontal and vertical size and position controls when using extended resolution modes.

# AutoCAD

The VGA 1024i supports AutoCAD in the following resolutions:

640 x 350	16 colors
752 x 410	16 colors
640 x 480	16 colors
720 x 540	16 colors
800 x 600	16 colors
1024 x 768	4 colors
1024 x 768	16 colors (requires 512K)

☞ The VGA 1024i AutoCAD Release 10 drivers on the VGA 1024i CAD Programs Disk supports both Release 10 and Release 9. Follow the same installation instructions for either version.

The V7REL10.COM driver supports ADI version 3 and above interface. It supports Fast Vector mode and Packet modes. The V7REL10.COM driver also supports AutoShade and AutoSketch.

☞ The instructions which follow assume that you have copied the files V7REL10.COM and V7INST.EXE to your hard disk.

## ***AutoCAD Installation***

The Release 10 AutoCAD ADI driver comes with one AutoCAD display driver and an installation program. The installation program allows you to change the currently selected resolution of AutoCAD's graphics screen, modify the software interrupt vector used by AutoCAD to communicate with the ADI display driver, and modify the colors used in several areas of the AutoCAD graphics screen.

Before you can begin working with AutoCAD you must load the ADI driver into your computer's memory. This procedure must be done every time you turn your computer on, or when you perform a warm boot. It is therefore suggested that the command to load the ADI driver be placed in your AUTOEXEC.BAT file.



To install the ADI driver, type:

V7REL10 <Enter>

This command will load the ADI driver into the computer's memory. The driver will then display identification information on the screen, and confirm that it has been installed. The driver will also notify you as to which interrupt vector will be used to communicate with AutoCAD.

## ***AutoCAD ADI Configuration***

AutoCAD need only be configured for the ADI General Display Driver once. Even if you turn off your computer or reboot it, AutoCAD will remember that the ADI General Display Driver has been installed. Follow the procedure outlined below to configure AutoCAD:

**Step 1** Start AutoCAD as described in the AutoCAD documentation.

**Step 2** When AutoCAD's Main Menu appears, select "Configure AutoCAD." This will be done automatically if AutoCAD senses that it has not yet been configured.

**Step 3** After reviewing your current configuration, press <Enter>

**Step 4** Select: "Configure Video Display" and press:

Y (Selects "Different Video Display")

**Step 5** Press:

1 (Chooses ADI)

**Step 6** AutoCAD will ask you a series of questions. Consult the AutoCAD Installation and Performance Guide for more details on these options.

**Step 7** When you have completed the series of questions, press:

Y (To save configuration)

## ***Controlling Resolution and Colors***

The VGA 1024i AutoCAD ADI driver allows you to choose different screen resolutions, colors, and interrupt vectors through the use of the Install Program V7INST.EXE.

**Step 1** At the DOS prompt, type:

```
V7INST <Enter>
```

The install program will prompt you for several responses. Text displayed between brackets is the default response. To accept the default response simply press the <Enter> key.

**Step 2** Enter name of driver to be modified. The default is V7REL10.COM. Press <Enter> to accept.

The name of the driver is required because the install program will modify both the memory resident version of the ADI driver and the file on your hard disk. This way any changes you make will be remembered for future sessions with AutoCAD.

You may wish to create several different versions of the driver to support different resolutions or colors. To do this simply copy the supplied driver to a file with a different name and then modify it to the desired settings.

**Step 3** You will be prompted for an interrupt vector number. The supplied default, 7A will work correctly under most circumstances. The only reason you will ever want to modify this interrupt vector is if the default value conflicts with some other software you might have in your system.

**Step 4** Configure AutoCAD resolution. The following menu will appear on your screen:

Resolution Data

Current Resolution is:

0: 640 x 480 by 16 colors

Available Resolutions are:

1: 640 x 480 by 16 colors

2: 752 x 410 by 16 colors

3: 640 x 350 by 16 colors

4: 720 x 540 by 16 colors

5: 800 x 600 by 16 colors

6: 1024 x 768 by 4 colors

7: 1024 x 768 by 16 colors

Enter selection [0]:

- ✓ The resolution you can select depends upon your type of monitor and/or the VGA 1024i memory configuration.

**Step 5** Configure AutoShade rendering resolution. Your screen will look similar to the following:

AutoShade 256 Color Rendering  
Display Resolution

Current Resolution is:

0: 640 x 400 by 256 colors

Available resolutions are:

1: 320 x 200 by 256 colors

2: 640 x 400 by 256 colors

3: 640 x 480 by 256 colors

Enter selection [0]:

- ✓ The resolution you can select depends upon your type of monitor and/or the VGA 1024i memory configuration.

**Step 6** Select the AutoCAD color model, either Release 9 or Release 10 depending on your version of AutoCAD.

## **Step 7** Select Configuration Data.

You will be presented with the options of changing the:

- number of command lines
- screen colors
- palette colors
- 256 color settings

You can modify any of the above or use the default settings.

- If you choose to modify the screen colors you will be asked to make selections from the following list of colors.
- If you choose to modify the palette colors you will be asked to enter new palette colors in hexadecimal notation.
- If you choose to modify the 256 color setting you will have the option of changing each of the 256 drawing colors.

The chart below indicates the 16 screen colors and their corresponding numbers:

<b>Number</b>	<b>Color</b>
0	Black
1	Red
2	Yellow
3	Green
4	Cyan
5	Blue
6	Magenta
7	Grey
8	Dark Grey
9	Dark Red
10	Dark Brown
11	Dark Green
12	Dark Cyan
13	Dark Blue
14	Dark Magenta
15	White

For the Graphics Area Background color of the drawing area, you may select either a dark (black) or a light graphics area background. If you select a light graphics area background, then lines drawn in color 7 will be drawn in black instead. This choice most closely resembles a black ink drawing on paper. Graphics area and text area background colors are applicable only to the V7REL10.COM driver.

Some of the colors you will be selecting will not correspond to the table listed above. This is because the color you are selecting will be XOR'd with the color it is overlaying. In particular this is true of the XOR color, the Menu Highlight color, the grid dot color, and the cursor color.

You can change screen colors while in AutoCAD. Use the AutoCAD SHELL command and run V7INST.EXE and then type "EXIT" to return to AutoCAD.

## ***AutoShade ADI Configuration***

The VGA 1024i supports AutoShade in the following resolutions:

320 x 200	256 colors
640 x 400	256 colors
640 x 480	256 colors (requires 512K)

The following AutoShade instructions are applicable to the V7REL10.COM driver. When AutoShade is first run it will request information from you in order to properly configure itself.

**Step 1** When provided the selection of the Display Devices, choose "AutoDesk Device Interface Rendering Driver" (Press "1").

 The interrupt vector initially used should be "7Ah" and should correspond to the interrupt vector to which the ADI driver has been configured.

**Step 2** When provided the selection of the Rendering Display Devices, again choose "AutoDesk Device Interface Rendering Driver" (Press "1").

 Use the default "7Ah" interrupt driver as outlined above.

**Step 3** When presented with the question: "Do display and rendering devices share a single screen?", respond with "YES."

## ***AutoCAD Dual Screen Mode***

V7REL10.COM supports a dual screen mode of operation. If you have a monochrome monitor and display adapter in your system along with the VGA 1024i you can operate AutoCAD in a mode which uses both monitors.

To use the dual screen mode your monochrome monitor and display adapter must be active before starting AutoCAD. If it is not already active type:

MODE MONO <Enter>

The V7REL10.COM driver will automatically configure AutoCAD for dual screen mode.

- ☞ In dual screen mode, the VGA 1024i must be configured for a resolution other than 1024 x 768 with 2 colors. You cannot have a monochrome display adapter co-resident when the VGA 1024i is configured for this mode.

## GEM/3

The VGA 1024i supports GEM/3 in the following resolutions:

640 x 480	16 colors
720 x 540	16 colors
800 x 600	16 colors
1024 x 768	16 colors (requires 512K)

- ☞ Drivers included on the VGA 1024i Utility Disk #2 work for GEM/3 version 3.1 and 3.0.

### *Installing GEM*

- ☞ If you already have GEM/3 installed, follow Steps 5 through 12 below.

**Step 1** Place the GEM/3 System Master Disk in Drive A and type:

GEMSETUP <Enter>

**Step 2** Select "Install New Configuration."

**Step 3** When asked for the Graphics Card and Display Installed in your System, select "IBM 16 Color VGA" or "IBM VGA Monochrome" and press <Enter>.

**Step 4** Follow instructions to complete setup.

**Step 5** When GEM/3 has been successfully installed, insert the GEM/3 System Master Disk in Drive A and type:

GEMSETUP <Enter>

**Step 6** This time, select "Change Existing Configuration." Your current configuration should be displayed. Select "Continue."

**Step 7** Next select: "Change Your Current Setup."

**Step 8** Select the graphic card and display you previously installed.

**Step 9** You will be asked for the Graphic Card and Display Installed in your System. Select "Other (Driver Pack)."

**Step 10** When asked for the GEM Driver Pack Disk, insert the **VGA 1024i Utility Disk #2** in Drive A and select "Continue."

A "Busy" message will be displayed on your screen, then the list of Graphics Cards and Displays will be displayed with the inclusion of the VGA 1024i available drivers.

Select the mode you wish to install. Your new configuration should be displayed.

**Step 11** Select "Save and Exit."

**Step 12** Follow instructions provided on your screen.



## Generic CADD Level 3

The VGA 1024i supports Generic CADD in the 1024 x 768 16 color resolution. This mode requires 512K of memory on the VGA 1024i. Support for the 800 x 600 16 color mode is provided with the Generic CADD program.

 Drivers are on the VGA 1024i CAD Programs Disk.

### *Installing Generic CADD*

**Step 1** Place the **VGA 1024i CAD Programs Disk** in Drive A. Copy the file GCAD1024.VGD into the Generic CADD sub-directory of your hard disk.

**Step 2** At the DOS prompt, run the Generic CADD "CONFIG" program by typing:

```
CONFIG <Enter>
```

**Step 3** Select "VGA 1024i 1024 x 768 by 16 color driver."

**Step 4** Exit CONFIG and run Generic CADD as usual.

## Lotus 1-2-3 and Symphony

The VGA 1024i supports 1-2-3 and Symphony in the following resolutions:

132 x 25	16 colors
132 x 43	16 colors
100 x 60	16 colors
80 x 60	16 colors
720 x 540	16 colors
800 x 600	16 colors

 Drivers included on the VGA 1024i Utility Disk #1 work for 1-2-3 versions 2.x and Symphony version 1.2.

## ***Installing 1-2-3 or Symphony***

**Step 1** The following files are the Lotus driver files. Copy the files you wish to use to the 1-2-3 and/or Symphony subdirectory on your hard disk.

FILE NAME	RESOLUTION	MONITOR TYPE
VD132x25.DRV	132 x 25 - Text	VFD, AD
VD132x43.DRV	132 x 43 - Text	VFD, AD
VD100X60.DRV	100 x 60 - Text	VFD, AD
VD80X60.DRV	80 x 60 - Text	VFD, AD
GD720V20.DRV	720 x 540 - Graphics	VFD
GD800V20.DRV	800 x 600 - Graphics	VFD

 If using a floppy drive system, insert the **VGA 1024i Utility Disk #1** in Drive A when prompted.

**Step 2** Place the 1-2-3 or Symphony Utility disk in Drive A and type:

INSTALL <Enter>

**Step 3** Follow screen directions to "Main Menu."

**Step 4** Select "Advanced Options."

**Step 5** At the "Advanced Options Menu," select "Add New Drivers to Library."

**Step 6** Follow directions to add drivers.

**Step 7** Return to the "Advanced Options Menu."

**Step 8** Select "Modify Current Driver Set."

**Step 9** Select "Graphics Display."

**Step 10** You will be presented with a list of all available drivers. Select the driver you wish to install.

**Step 11** Select "Save Changes."

**Step 12** Follow instructions to name the new driver set or make it the default driver set and complete installation.

## P-CAD

The VGA 1024i supports P-CAD in the following resolutions:

640 x 480	16 colors
720 x 540	16 colors
800 x 600	16 colors
1024 x 768	16 colors (requires 512K)

 Drivers included on the VGA 1024i CAD Programs Disk work for P-CAD versions 3.0 and 4.0.

### *Installing P-CAD*

**Step 1** Install P-CAD choosing "IBM VGA" as the display adapter.

**Step 2** After completion of the installation process change to the P-CAD driver sub-directory by typing:

```
CD\PCAD\DRV <Enter>
```

**Step 3** Delete the IBM VGA driver. Type:

```
DEL DIBMVGA.DRV <Enter>
```

**Step 4** Place the **CAD Programs Disk** in Drive A. Copy the appropriate P-CAD driver for the resolution you wish to install to the PCAD\DRV directory.

FILE NAME	RESOLUTION	NO. OF COLORS
DPCAD640.DRV	640 x 480	16
DPCAD720.DRV	720 x 540	16
DPCAD800.DRV	800 x 600	16
DPCAD1K.DRV	1024 x 768	16

- Step 5** Use an editor to modify the P-CAD configuration file "PCADDRV.SYS." Change "DIBMVGA.DRV" to the name of the file for the resolution you are installing (e.g. for the 800 x 600 mode, replace DIBMVGA.DRV with DPCAD800.DRV).
- Step 6** Reboot your computer for the change to take effect.

## Presentation Manager

The VGA 1024i supports Presentation Manager in the following resolutions:

640 x 480	16 colors
640 x 480	256 colors (requires 512K)
720 x 540	16 colors
800 x 600	16 colors
1024 x 768	16 colors (requires 512K)

 Drivers for Presentation Manger 1.1 are on the VGA 1024i Presentation Manger Disk.

**Step 1** Boot your computer using either a DOS or OS/2 floppy disk.

**Step 2** Place the **VGA 1024i Presentation Manager Disk** in Drive A and type:

```
PMINST <Enter>
```

Follow the instructions provided on the screen to select the resolution you wish to install as well as the type of monitor you are using.

# Ventura Publisher

The VGA 1024i supports Ventura in the following resolutions:

640 x 480	2 or 16 colors
720 x 540	2 or 16 colors
800 x 600	2 or 16 colors
1024 x 768	2 or 16 colors (requires 512K)

 Drivers included on the VGA 1024i Utility Disk #2 work for Ventura versions 2.0 and 1.x (2 color modes).

## *Installing Ventura Publisher*

**Step 1** Install Ventura Publisher as described in the documentation supplied with it. Select the VGA display device driver.

**Step 2** After installation is complete place the **VGA 1024i Utility Disk #2** into Drive A.

**Step 3** Log into Drive A and type:

```
VPINST <Enter>
```

**Step 4** Follow the directions provided on your screen.

# VersaCAD Design

The VGA 1024i supports VersaCAD in the following resolutions:

640 x 480	16 colors
720 x 540	16 colors
800 x 600	16 colors
1024 x 768	16 colors (requires 512K)

 Drivers included on the VGA 1024i CAD Programs Disk work for VersaCAD Design versions 5.3 and 5.4.

There are two resolution files and two configuration files on the CAD Programs Driver Disk. VCAD53.CFG is the configuration file for VersaCAD Design 5.3 and VCAD54.CFG is for VersaCAD Design 5.4. The following instructions are specifically for VersaCAD Design 5.3. Replace all references to VCAD53.CFG with VCAD54.CFG if you have VersaCAD Design 5.4.

## ***Installing VersaCAD***

**Step 1** Place the **VGA 1024i CAD Programs Disk** in Drive A.

**Step 2** Copy the file for the resolution you wish to install to the VersaCAD directory of your hard disk.  
Type:

```
COPY A:VCAD800.EXE [path]VCAD53 <Enter>
```

to install the 640 x 480, 720 x 540 or 800 x 600 resolution driver or

```
COPY A:VCAD1024.EXE [path]VCAD53 <Enter>
```

to install the 1024 x 768 resolution driver.

**Step 3** Copy the configuration file from the **CAD Programs Disk** to your VersaCAD directory by typing:

```
COPY A:VCAD53.CFG [path]VCAD53 <Enter>
```

**Step 4** Use an editor to modify the VersaCAD batch file (usually in the root directory of your hard disk) to include the driver name you used in step 2. For example, type:

```
EDLIN VCAD53.BAT <Enter>  
CD \VCAD53  
VCAD800  
VRUN
```

Save your changes.

**Step 5** Change to the VCAD53 directory and start VersaCAD.

**Step 6** Select [E] to change the screen configuration.

**Step 7** Select the desired resolution.

## **Windows/286**

The VGA 1024i supports Windows/286 in the following resolutions:

640 x 400	256 colors
640 x 450	16 colors
640 x 480	16 colors
640 x 480	256 colors (requires 512K)
720 x 540	16 colors
800 x 600	16 colors
1024 x 768	2 colors
1024 x 768	16 colors (requires 512K)

 Drivers included on the VGA 1024i Utility Disks #1 and #2 work for Windows versions 2.x.

All applications that run under the Windows environment will be displayed at the resolution you choose when installing Windows.

### ***Installing Windows/286***

**Step 1** Run the Windows SETUP program as described in the Microsoft Windows documentation.

**Step 2** When asked to select or confirm the type of display adapter, choose "other."

 Windows/286 SETUP automatically detects your system configuration. It will default to "VGA." Select this as the option to change, then select "OTHER" to install the VGA 1024i drivers.

**Step 3** Place the appropriate **VGA 1024i Utility Disk** in Drive A and press <Enter> to continue with the installation. Windows will automatically load all available drivers.

 Use **Utility Disk #1** to install the 16-color drivers or **Utility Disk #2** to install the 256-color drivers.

**Step 4** Select the driver you wish to install from the list of available drivers displayed on your screen.

✓ Your monitor must be able to support the resolution you choose when installing Windows. Attempting to install Windows at a resolution higher than your monitor can display may cause damage to your monitor. See "*Appendix D - Programmer's Information / Text and Graphics Modes*" for monitor requirements.

**Step 5** Next you will be asked to select the fonts you wish to use. We recommend that the VGA fonts be used for all of the VGA 1024i drivers.

**Step 6** Continue with the rest of the Windows SETUP program to complete the full installation.

## Windows/386

The VGA 1024i supports Windows/386 in the following resolutions:

640 x 400	256 colors
640 x 450	16 colors
640 x 480	16 colors
640 x 480	256 colors (requires 512K)
720 x 540	16 colors
800 x 600	16 colors
1024 x 768	2 colors
1024 x 768	16 colors (requires 512K)

 Drivers included on the VGA 1024i Windows/386 Disk work for versions 2.x.



The VGA 1024i Windows/386 Device Drivers allow you to select up to four drivers to be available when installing Windows/386. You can change or select which four of the available drivers you want at any time before installing Windows/386.

## ***Installing Windows/386***

**Step 1** Place the **VGA 1024i Windows/386 Device Drivers Disk** in Drive A and type:

SELECT <Enter>

Follow the instructions on your screen to select the drivers you want available to install.

**Step 2** Place the Windows/386 SETUP disk in Drive A and run the SETUP program as described in the Microsoft Windows documentation.

 Windows/386 SETUP automatically detects your system configuration. It will default to "VGA." Select this option, then select "OTHER" to install the VGA 1024i drivers.

**Step 3** Place the **VGA 1024i Windows/386 Disk** in Drive A and press <Enter> to continue with the installation. The Windows SETUP program will automatically load all selected drivers.

**Step 4** Select the driver you wish to install from the list of drivers displayed on your screen.

✓ Your monitor must be able to support the resolution you choose when installing Windows/386. Attempting to install Windows/386 at a resolution higher than your monitor can display may cause damage to your monitor. See "Appendix D - Programmer's Information/Text and Graphics Modes" for monitor requirements.

**Step 5** Next you will be asked to select the fonts you wish to use. We recommend that the VGA fonts be used for all of the drivers provided on this disk.

**Step 6** Continue with the rest of the SETUP program to complete the full installation.

# WordPerfect

The VGA 1024i supports WordPerfect in the following resolutions:

132 x 25	16 colors
132 x 43	16 colors
100 x 60	16 colors
80 x 60	16 colors
800 x 600	16 colors
1024 x 768	16 colors (Requires 512K)

 Text drivers work for WordPerfect version 4.2 and 5.0. The 800 x 600 and 1024 x 768 graphics drivers on the VGA 1024i Utility Disk #2 work for version 5.0.

## *Installing WordPerfect Text Drivers*

**Step 1** To bring up the WordPerfect Setup Menu, type:

WP/S <Enter>

**Step 2** Choose selection #3, "Set screen and beep options."

**Step 3** Follow menu instructions to type the number of rows and columns desired, press <Enter> until you return to the Setup Menu.

**Step 4** Choose selection #0 to accept the changes and enter WordPerfect. The configuration will be in effect until the setup is changed.

 Before running WordPerfect, you must run ESU.COM to select the text mode for which you have configured WordPerfect.

## *Installing WordPerfect Graphics Drivers*

**Step 1** Copy the WordPerfect graphics drivers from the **VGA 1024i Utility Disk #2** to the WP50 directory of your hard disk.

**Step 2** Bring up the WordPerfect Setup Menu.

**Step 3** Choose selection #3 "Display," then select #5 "Graphics Screen Type."

**Step 4** Select the resolution you wish to use.

## WordStar 3.3

**Step 1** At the DOS prompt, type these commands in the order given:

```
COPY WS.COM WS132.COM <Enter>
```

```
DEBUG WS132.COM <Enter>
```

**Step 2** You will now be in the "DEBUG" program. You will now type a command in which you use hexadecimal notation to specify the number of rows (minus 1) and the number of columns. The format is:

```
-e248 [rows -1] [cols] <Enter>
```

Hexadecimal equivalents are listed below. To set mode 42 (132 x 43), the command would be:

```
-e248 2A 84 <Enter>
```

where the hexadecimal equivalents are "2A" for 43 rows and "84" for 132 columns.

### *Hexadecimal equivalents*

DECIMAL	HEX	ROWS -1
25	19	18
43	2B	2A
60	3C	3B
80	50	
100	64	
132	84	

**Step 3** At the DEBUG prompt, type these commands:

W <Enter>

Q <Enter>

- ✱ When setting up WordStar in 43 line mode, do not choose EGA 43 line mode from the WordStar Monitor Selection menu. Use the Console Screen Size menu to set the number of rows and columns instead. Using ESU and the WordStar internal 43 line mode will lead to incorrect results.

Choose the desired text mode per the instructions in "Enhancement Selection Utility" in Section Three. The mode setting command (ESU/[mode number]) can be included in your AUTOEXEC.BAT file.

- ✓ Refer to your DOS Manual if you need further information about DEBUG and/or about editing your AUTOEXEC.BAT file.

## **WordStar Professional 4.0, 5.x**

**Step 1** Use the WSCHANGE program to configure WordStar 4.0 for use with the VGA 1024i extended text modes.

**Step 2** Run ESU.COM to select the mode you set in Step 1.

- ☞ Follow the same procedure for WordStar 5.x

### ***BUILT-IN VIDEO AND TWO MONITOR SYSTEMS***

You have the option of using another display adapter and monitor in conjunction with the VGA 1024i and its associated monitor. This additional display adapter/monitor may be added into your system or built-in. The VGA 1024i will only work with certain combinations of an additional display adapter/monitor.

- \* DO NOT use any EGA or VGA as a second adapter when using the VGA 1024i. If you have a system with EGA or VGA built in, you must disable it before installing the VGA 1024i. Consult your system user's guide for how to do this.

You cannot have an MDA or HGC co-resident if you are using the VGA 1024i in the 1024 x 768, 2 color mode.

You may use a Monochrome Display Adapter (MDA) or a Hercules Graphics Card (HGC) with a Monochrome Display (MD). Or, you may use a Color Graphics Adapter (CGA) with either a Color Display (CD) or Enhanced Color Display (ECD).

The capability of the VGA 1024i and Primary Display is altered by the type of second display adapter/monitor combination.

All display adapters use a portion of a computer's memory for color and monochrome attributes. The simple concept to remember is that in your computer's memory, you cannot have two things occupying the same space:

- If your second display adapter/monitor combination is color, then the color capability of the VGA 1024i/monitor will not be available.
- If your second display adapter/monitor combination is monochrome, then the monochrome capability of the VGA 1024i/monitor will not be available.

## **The VGA 1024i as the Secondary Adapter**

Upon booting, the VGA 1024i will initialize itself as the primary display adapter in your system. If you have a co-resident graphics adapter, you can cause the VGA 1024i to function as the secondary adapter by following these steps before turning your system on:

- Step 1** Make sure the monitor connected to the VGA 1024i is off. Disconnect the monitor cable from the VGA 1024i.
- Step 2** Boot your computer.
- Step 3** Reconnect the monitor cable to the VGA 1024i.
- Step 4** Turn the monitor ON.

## **SWITCH AND JUMPER SETTINGS**

### **Switch Settings**

The default setting for switches on the VGA 1024i are generally the best option for most systems. Should you have difficulties, you may want to try some different switch settings. The default setting is with all switches ON.

 Refer to "*Part Two - The VGA 1024i Installation / Parts of the VGA 1024i*" for switch block location.

If the switches on the VGA 1024i are labelled "OPEN" on one side rather than being labelled "ON" and "OFF" on opposite sides, "OPEN" is equivalent to "OFF."

Any time you reset the switches you must re-boot your computer for the changes to take effect.

#### ***Switches 1 through 3***

Switches 1, 2, and 3 are currently non-functional. They should be left in the default position which is ON.

#### ***Switch 4 - FastWrite™ Feature***

Switch 4 enables/disables the VGA 1024i's "FastWrite" feature, Headland Technology's proprietary memory caching mechanism which reduces wait states to virtually zero. Occasionally, the bus timing of a computer system will require FastWrite to be disabled. An indication of this is random characters on the screen after the VGA 1024i is initialized.

#### **Switch 4**

<b>ON</b>	FastWrite enabled	<b>(Default)</b>
<b>OFF</b>	FastWrite disabled	

## ***Switch 5 - Emulation Modes***

Switch 5 controls the VGA 1024i's ability to emulate CGA and HGC modes. To set an emulation mode use the V7VGA.COM utility.

### **Switch 5**

- ON**            Enable emulation    **(Default)**
- OFF**           Disable CGA and HGC emulation

## ***Switch 6 - Force 8-bit ROM Access***

It is possible to force the VGA 1024i into an 8-bit BIOS mode by resetting switch 6. Setting an 8-bit BIOS access does not affect the performance of graphics software as most software bypasses the BIOS and writes directly to the hardware. This switch is generally used in conjunction with jumper E2 (see following page). You may reset switch 6 as follows:

### **Switch 6**

- ON**            Allow 16-bit ROM access    **(Default)**
- OFF**           Force 8-bit ROM access

## ***Switch 7 - Automatic Memory Sensing***

The VGA 1024i automatically detects whether your computer can operate in 8- or 16-bit memory access mode. In the rare instance that your computer prevents this auto-detection, you can reset switch 7 as follows:

### **Switch 7**

- ON**            Allow 16-bit Memory access    **(Default)**
- OFF**           Force 8-bit Memory access



## ***Switch 8 - VGA Pure Mode***

The VGA 1024i offers extension registers beyond the IBM VGA standard. Some operating environments are sensitive to the use of these extension registers. If Switch 8 is OFF, the VGA 1024i BIOS will not access any extension registers after initialization.

Turning Switch 8 OFF also prevents the BIOS from accessing extended modes such as the 800 x 600 - 16 color mode. VGA pure mode can also be controlled by the V7VGA.COM program regardless of how Switch 8 is set.

### **Switch 8**

<b>ON</b>	Enable VGA 1024i extensions	<b>(Default)</b>
<b>OFF</b>	Force VGA only modes	

## **Jumper Settings**

The default setting for jumpers on the VGA 1024i are generally the best option for most systems. Pins 1 and 2 enable a feature, pins 2 and 3 disable the feature.

**E1: Default - pins 2 and 3.** The jumper labelled E1 controls the VGA 1024i's use of the vertical interrupt, IRQ2. In the default position IRQ2 is disabled. In a few instances is it necessary to enable the vertical interrupt by moving the shunt to pins 1 and 2.

**E2: Default - pins 1 and 2.** The jumper labelled E2 controls the tight 16-bit ROM decode. In its default position, full decode of the 16-bit ROM in the C000-C7FF memory segment is enabled. With the shunt on pins 2 and 3, the VGA 1024i decodes the 16-bit ROM in memory segments C000-DFFF. This can cause memory address conflicts with some EMS cards or other peripherals.

If sensitivity of your computer system requires you to move the shunt on E2 from the default position, you can "regain" the D000 segment by setting switch 6 OFF.



### **V7VGA.COM COMMAND SUMMARY**

Each command listed below is described in detail in "*Part Three - The VGA 1024i Software / The VGA 1024i Utility Program.*"

<b>Command</b>	<b>Description</b>
V7VGA CGA:ON	Enable Color Graphics emulation
V7VGA CGA:OFF	Disable Color Graphics emulation
V7VGA MONO:ON	Enable 64K HGC emulation mode
V7VGA MONO:OFF	Disable HGC emulation mode
V7VGA MONO:HALF	Enable 32K HGC emulation mode
V7VGA MONO:FULL	Enable 64K HGC emulation mode
V7VGA SAVE:ON	Enable screen saver
V7VGA SAVE:OFF	Disable screen saver
V7VGA SAVE:[n]	Enable screen saver for "n" minutes
V7VGA NOSAVE	Disable screen saver
V7VGA PURE:ON	Enable <i>pure</i> IBM VGA standard modes, disables extensions
V7VGA PURE:OFF	Disables VGA <i>pure</i> mode, enables extensions





---

**TECHNICAL INFORMATION**

**Monitor Specifications**

***Analog Display Pinouts***

Pin	Function
1	Red
2	Green
3	Blue
4	Monitor ID Bit 2
5	not used
6	Red Return (ground)
7	Green Return (ground)
8	Blue Return (ground)
9	Key (no pin)
10	Sync Return (ground)
11	Monitor ID Bit 0
12	Monitor ID Bit 1
13	Horizontal Sync (+)
14	Vertical Sync (-)
15	not used

 The VGA 1024i uses the standard 15-pin analog display pinout configuration. Consult your monitor User Guide or contact the manufacturer for their pinouts as each monitor varies.

***Feature Connector Pinouts***

The VGA 1024i supports the standard IBM VGA feature connector pinouts.

## ***Monitor Timings for the VGA 1024i Extended Graphics Modes***

The VGA 1024i's extended graphics resolution of 800 x 600 requires a variable frequency display such as the NEC MultiSync or Sony Multiscan. The 1024 x 768 resolution, which is an interlaced mode, requires a monitor such as the NEC MultiSync 3D, the IBM 8514 or the Seiko CM-1430. Please note that ***not all*** monitors are capable of displaying the above resolutions. The chart below indicates the necessary scan frequencies (monitor timings) for the VGA 1024i extended graphics modes.

 *Modes are listed in hexadecimal notation.*

### ***256K DRAM Configuration:***

<b>Mode</b>	<b>Resolution</b>	<b>Colors</b>	<b>Monitor Timings</b>	
			<b>Vertical</b>	<b>Horizontal</b>
60	752 x 410	16	70 Hz	31.0 KHz
61	720 x 540	16	60 Hz	35.0 KHz
62	800 x 600	16	56 Hz	35.0 KHz
63	1024 x 768	2	43 Hz	35.5 KHz
64	1024 x 768	4	43 Hz	35.5 KHz
66	640 x 400	256	70 Hz	31.1 KHz

### ***512K DRAM Configuration:***

<b>Mode</b>	<b>Resolution</b>	<b>Colors</b>	<b>Monitor Timings</b>	
			<b>Vertical</b>	<b>Horizontal</b>
65	1024 x 768	16	43 Hz	35.5 KHz
67	640 x 480	256	60 Hz	31.5 KHz

 This list reflects timings that are within the specifications of most monitors. The VGA 1024i ALTPARM.COM utility can be used to improve the display on monitors that have different horizontal and/or vertical scan rates.

# Programmer's Information

## *Text and Graphics Modes*

 Modes are listed in hexadecimal notation.

### ***256K DRAM Configuration:***

<b>Mode</b>	<b>Resolution</b>	<b>Colors</b>	<b>Monitors</b>	<b>Type</b>
0, 1	40 x 25	16	VFD, AD	Text
2, 3	80 x 25	16	VFD, AD	Text
4, 5	320 x 200	4	VFD, AD	Graphics
6	640 x 200	2	VFD, AD	Graphics
7	80 x 25	4	VFD, AD	Text
D	320 x 200	16	VFD, AD	Graphics
E	640 x 200	16	VFD, AD	Graphics
F	640 x 350	4	VFD, AD	Graphics
10	640 x 350	16	VFD, AD	Graphics
11	640 x 480	2	VFD, AD	Graphics
12	640 x 480	16	VFD, AD	Graphics
13	320 x 200	256	VFD, AD	Graphics
40	80 x 43	16	VFD, AD	Text
41	132 x 25	16	VFD, AD	Text
42	132 x 43	16	VFD, AD	Text
43	80 x 60	16	VFD, AD	Text
44	100 x 60	16	VFD, AD	Text
45	132 x 28	16	VFD, AD	Text
60	752 x 410	16	VFD	Graphics
61	720 x 540	16	VFD	Graphics
62	800 x 600	16	VFD	Graphics
63	1024 x 768	2	ID	Graphics
64	1024 x 768	4	ID	Graphics
66	640 x 400	256	VFD, AD	Graphics

### ***512K DRAM Configuration:***

<b>Mode</b>	<b>Resolution</b>	<b>Colors</b>	<b>Monitors</b>	<b>Type</b>
65	1024 x 768	16	ID	Graphics
67	640 x 480	256	VFD, AD	Graphics

Monitors: AD - Fixed-Frequency Analog Display  
 VFD - Variable-Frequency Display  
 ID - Interlaced Display



## ***Sample Code Fragments***

1. Interface to text and graphics modes:

```
AH = 6Fh
AL = 05h
BL = MODE NUMBER (See list above)
```

2. Sample Code to verify the VGA 1024i is installed:

```
MOV AH, 6Fh
MOV AL, 00
INT 10h
```

Returns "V" in BH and "7" in BL registers to verify a Video Seven board is installed.

3. Sample Code to set mode:

```
MOV AH, 6Fh
MOV AL, 05h
MOV BL, [MODE NUMBER] (See list above)
INT 10h
```

4. Sample Code to get mode:

```
MOV AH, 6Fh
MOV AL, 04h
INT 10h
```

**Exit:**

**AL = Current Video Mode**

**BX = Horizontal Columns/Pixels (Text/Graphics)**

**CX = Vertical Rows/Pixels (Text/Graphics)**

## ***Technical Reference Manual***

Details on programming the VGA 1024i are in the *VGA 1024i Technical Reference Manual*. To obtain a copy, send your request along with a check or money order for \$25.00 to:

VGA 1024i Technical Reference Manual  
Headland Technology Inc.  
46221 Landing Parkway  
Fremont, CA 94538

 Only U.S. funds will be accepted. Make check payable to Headland Technology Inc. California residents must add applicable sales tax. Overseas shipments add \$10.00 for air delivery.

## ***Additional Resources***

The following books may be of further assistance for programming:

EGA/VGA - A Programmers Reference Guide,  
Bradley Klierer  
Intertext Publications  
McGraw-Hill Book Company  
11 W. 19th, New York, NY 10011  
Copyright 1988

Programmer's Guide to PC and PS/2 Video Systems,  
Richard Wilton  
Microsoft Press  
16011 N.E. 36th Way, Box 97017  
Redmond, WA 98073  
Copyright 1987

## Upgrading to 512K

The VGA 1024i can be configured with 256K or 512K of Dynamic Random Access Memory. Upgrading it to 512K gives you more on-screen colors in the high resolution modes. The additional capabilities include 1024 x 768 with 16 colors and 640 x 480 with 256 colors.

The VGA 1024i comes with 8 DRAM soldered on the board and 8 sockets where an additional 256K of DRAM can be placed. The DRAM that can be used in the upgrade is 100 nanosecond or faster, 64K x 4 DIP package type. Approved vendors include:

<b>Vendor</b>	<b>Part Number</b>
NEC	D41464C-10
Sharp	LH2464-10
Mitsubishi	M5M4464P-10
Fujitsu	MB81464-10
Hyundai	HY53C46LS-10

### ***Where to get DRAM***

The additional DRAM can usually be purchased from your dealer, local computer electronics stores or through mail order. The classified sections of most major computer publications usually have advertisements for DRAM. Be sure you obtain the type and part numbers listed above.

A 256K Memory Upgrade Kit can be purchased from Headland Technology. Information on ordering the memory direct can be obtained by calling the Customer Service telephone numbers:

- 415-656-7800 Worldwide
- 800-248-1850 U.S. and Canada
- 800-553-1850 California

 All available drivers are included on the Utility and Driver Disks packaged with the VGA 1024i. You do not need any additional software when upgrading to 512K of memory.

## ***Installation of DRAM***

The VGA 1024i has eight sockets adjacent to the eight DRAM soldered onto the board. This is where the additional DRAM will be placed.

\* Always make sure your computer is turned off and the power supply cable is disconnected before removing the VGA 1024i from your system. Exercise usual precautions when handling the DRAM to avoid static electric damage.

- Step 1** Place the VGA 1024i on a flat surface with the gold edge connectors towards you and the bracket on the right.
- Step 2** Carefully insert each DRAM with the notched edge facing left. This direction is indicated by the drawing on the PC board. It also matches the orientation of the DRAM soldered on the board. Insert each DRAM chip until it is seated snugly. Be very careful not to bend the pins when inserting the DRAM.
- Step 3** Re-install the VGA 1024i in your system following the procedures outlined in Part 2. To confirm that the DRAM are installed correctly and are functioning properly run the V7DIAG.EXE program. The first screen of the diagnostics program should indicate you have 512K of display memory.
- Step 4** If V7DIAG indicates you have 256K of memory, you may have to remove the VGA 1024i and check to see that all of the DRAM pins are secure in each socket and are all facing the correct direction.

# TROUBLESHOOTING

## Hardware Troubleshooting

- Make sure the VGA 1024i is firmly seated in its expansion slot, and that it is not touching other boards in your system.
- The VGA 1024i works properly in an IBM PC, PC/XT, PC/AT, or a PS/2 Model 30, or 100% compatible.
- If using an IBM PC, check that your BIOS ROM is up-to-date. The VGA 1024i is designed to work with IBM PC BIOS dated October 27, 1982 or later. To check the date of your PC BIOS ROM, run the ROMDATE.COM utility on the **VGA 1024i Utility Disk #1**.
- Be sure your monitor cable is properly connected to the VGA 1024i and that your monitor power switch is on. You may also need to verify the accuracy of your cable pinout configuration.
- Check your computer's switch and jumper settings, and those on the VGA 1024i to insure that all settings are correct for your computer system.
- Run the VGA 1024i Diagnostics Program.
- The VGA 1024i uses the following addresses:

I/O:	3B0-3DF
Video RAM:	A000-BFFF
8-bit Video ROM:	C000-C7FF
16-bit Video ROM (def.):	C000-C7FF
16-bit Video ROM (alt.):	C000-DFFF
IRQ2	
- Make sure other peripherals such as EMS cards, disk controllers or LAN cards are not using the same memory address as the VGA 1024i. Check with the manufacturer or your Owner's Manual for information

about designating exclusions for memory locations when invoking your device driver.

- If your screen displays random characters after initialization, try turning Switch 4 OFF. This should eliminate any possible bus timing incompatibilities between your computer and the VGA 1024i. Or, your computer may be sensitive to the VGA 1024i tight ROM decode in which case you should try setting Jumper E2 to pins 2 and 3.

### ***Commonly asked questions about monitors***

- Q. *Why does the picture shift or change size when changing modes on my variable frequency monitor?*
- A. Some variable frequency monitors don't synchronize properly to the signals coming from the graphics board, causing the image to shift or reduce in size. Use ALTPARM.COM on the VGA 1024i Utility Disk #1 to prevent this from occurring. Additionally, slight adjustments of the horizontal and vertical positions may be necessary.
- Q. *The 800 x 600 mode runs off the top and bottom of my MultiSync screen. What do I do?*
- A. Set the MultiSync "MANUAL" switch (located at the back of the monitor) to ON.
- Q. *What monitors are capable of displaying the 800 x 600 resolution? The 1024 x 768 resolution?*
- A. Most variable frequency monitors such as the NEC MultiSync, the Sony Multiscan, the Nanao Flexscan, and the Mitsubishi DiamondScan are capable of displaying 800 x 600. Specifically, the monitor must be capable of a 35-37 KHz horizontal scan rate at 56-60 Hz vertical. To run the 1024 x 768 interlaced resolution, monitors must be capable of a 35.5 KHz horizontal at a 43 Hz vertical scan rate.

Q. *What monochrome monitors can I use with the VGA 1024i?*

A. Only analog monitors such as the NEC MultiSync GS or the IBM 8503 can be used. The VGA 1024i is not compatible with digital monochrome monitors.

### ***Commonly asked questions about systems***

Q. *After installing the VGA 1024i my computer emits several short beeps and there is no video. Is my VGA card dead on arrival?*

A. Check to make sure all connections are solid. The VGA 1024i needs to be firmly seated in the expansion slot. Try using a different slot. If your computer requires setup software, be sure it is set for VGA or EGA (refer to your system's operating guide).

Q. *Can I have two graphics boards in my system at the same time? Do I need to change the switches or jumpers?*

A. You can have either a monochrome card (IBM MDA or Hercules Graphics Card) or an IBM Color Graphics Adapter co-resident with the VGA 1024i. You cannot have another VGA or an EGA co-resident. No switches need to be set on the VGA 1024i.

Q. *I've just installed my VGA card, now when I move my mouse it leaves "trails" across the screen or acts erratically?*

A. The version of your mouse driver may not support VGA. Contact the manufacturer for the latest driver.

Q. *I've just upgraded my card to 512K of memory, now when I boot my system I get garbage on the screen. Is the memory bad?*

A. Check to see that all of the DRAM are facing the proper direction (with the notch facing left). Run the V7DIAG.EXE program to test the memory.

Q. *Why do I get garbage on my printer when I do a <Shift><Print Screen>?*

A. The <Shift><Print Screen> keystrokes can only be used to output ASCII characters to your printer. If you are displaying graphics images you need a program such as Pizazz Plus to output them to a supported printer.

## Software Troubleshooting

- Make sure you are using the correct V7VGA.COM commands when in HGC or CGA compatibility modes. See *"Part Three - The VGA 1024i Software / The VGA 1024i Utility Program"* for information on switching modes.
- Check your software. The VGA 1024i can emulate four different display adapters. Be sure you are using the correct software configuration.
- Your AUTOEXEC.BAT or CONFIG.SYS file may contain commands that are interfering with the operation of the VGA 1024i. Try booting your system without these files. If the VGA 1024i works properly, identify and remove the command(s) in your AUTOEXEC.BAT and/or CONFIG.SYS file that conflict with the proper operation of the VGA 1024i.
- If you are using Screen Saver and your screen goes blank when you are using the keyboard, disabling Screen Saver may solve the problem.
- If you have RAMBIOS.SYS installed and you have trouble running some software applications, try correcting the problem by removing RAMBIOS.SYS from your CONFIG.SYS file. Reboot your computer and try to run your software program. It may be that RAMBIOS is using memory that your software application needs in order to run properly.



### ***SERVICE AND TECHNICAL ASSISTANCE***

We are pleased to assist you with questions about the VGA 1024i. Technical Support is available:

Monday through Friday  
8:00 AM to 5:00 PM (Pacific Time)  
(800) 248-1850 (U.S. and Canada)  
(800) 553-1850 (California)  
(415) 656-7800 (Worldwide)

Or, you may FAX your technical questions to us:

(415) 657-4604

Please include your return FAX number and a telephone number where you can be reached.

#### ***Before Calling Technical Support***

Before calling Technical Support, please read through the symptoms and suggestions outlined in "*Appendix E - Troubleshooting.*" It may be that what you are experiencing is easily corrected.

#### ***Technical Support Bulletin Board Service***

Technical Support maintains a Bulletin Board Service. Access to the BBS is available 24 hours a day, seven days a week. Use the Bulletin Board as a forum for your technical or product related questions as well as for downloading:

- The latest version of Utility Disks.
- Current available software drivers.

- Beta versions of new software.
- Tech notes and other information about Headland Technology products.

You can access the Bulletin Board as follows:

Tel: (415) 656-0503

- 2400 bps
- 8 bits
- 1 stop bit
- no parity

### ***When You Call Technical Support***

To help us answer your questions, please have the following information handy when you call:

#### **1. SYSTEM DESCRIPTION**

- What kind of PC are you using?
- What Operating System(s) are you using?
- What is the version of the VGA 1024i BIOS? (The version appears on your screen when you boot up and when you use the Diagnostics Program.)
- What is the version of the VGA 1024i Utility Disks?
- What kind of peripheral boards are in you system?
- For how much RAM is your system configured?
- What kind of monitor are you using?

#### **2. SOFTWARE DESCRIPTION**

- What software package are you using and what is the version number?

- What display adapters does the software support?
- What graphics modes does the software support?
- What are the contents of your CONFIG.SYS and AUTOEXEC.BAT files?

### **3. THE PROBLEM IN DETAIL**

- What is the problem?
- What seems to have caused the problem to occur (e.g. the problem occurred when you changed modes)?

### ***Before Shipping the VGA 1024i To Us***

1. Call our Technical Support department and explain your system configuration and problems you are experiencing as outlined above. We may be able to help you get the VGA 1024i working properly over the phone.
2. If the VGA 1024i must be returned to us, the Technical Support representative will give you an RMA (Return Materials Authorization) number. **Use the enclosed address label, package the VGA 1024i carefully and write the RMA number plainly on the outside of the package.** We refuse shipment of Service/Repair items without an RMA number. Return the VGA 1024i, with transportation charges prepaid, to Headland Technology.
3. Include a copy of your sales slip for warranty service verification.

## ***Software Compatibility Guarantee***

Headland Technology Inc. guarantees that the Video Seven VGA 1024i is compatible with software written for these modes:

VGA	IBM Video Graphics Array
EGA	IBM Enhanced Graphics Adapter
CGA	IBM Color Graphics Adapter
MDA	IBM Monochrome Display Adapter
HGC	Hercules Graphics Card

We guarantee that any software that operates in an IBM PC/XT/AT or PS/2 Model 30 using the IBM Display Adapter, Enhanced Graphics Adapter, Color Graphics Adapter, Monochrome Display Adapter or Hercules Graphics Card will operate correctly if that display adapter is replaced with the VGA 1024i. If it doesn't, we'll make it work or refund the price you paid for the card.

If you think you have a problem call Technical Support. Tell the representative what software you are having trouble with (including the software version number) and we'll try to fix the problem within 30 days. If we can't, we will authorized the return of your VGA 1024i and sales receipt and send you a check by return mail.

### **GLOSSARY**

**ANSI:** American National Standards Institute.

**ASCII:** American Standards Committee on Information Interchange. A standard used by IBM and compatible computers to convert numbers to characters.

**Analog Display (AD):** A monitor that uses variable color control voltages to display a very large number of colors but requires very few inputs.

**BIOS (ROM BIOS):** Stands for Basic Input-Output System. Hidden code in your computer's ROM (Read Only Memory) that provides the power-on self test and other operating functions.

**CGA:** The IBM Color Graphics Adapter.

**Color Display (CD):** The IBM Color Display, capable of 640 x 200 resolution.

**Default Mode:** The capabilities, resolutions and display mode the VGA 1024i operates with when you start your system.

**Digital Display:** Also called TTL. A type of monitor that switches signals ON or OFF to determine display color. Types of digital displays include the IBM Enhanced Color Display or Monochrome Display. The VGA 1024i does not support digital monitors.

**Dip Switch:** Dual Inline Package switch; a series of tiny, two position switches which allow users to select and change options on computer boards, printers, and other peripherals.

**Driver:** Part of a software program that interacts with a particular piece of equipment in your computer system (i.e. video boards, printers, and keyboards).

**EGA:** The IBM Enhanced Graphics Adapter.

**EMS:** Expanded Memory Specification. Originally developed to break the DOS 640K limit, it is now used as a general term for types of add-in memory boards.

**Enhanced Color Display (ECD):** The IBM Enhanced Color Display capable of 640 x 350 resolution.

**Expansion Board:** A device used to expand a computer's capability such as the VGA 1024i.

**Expansion Slot:** An electrical connection within the computer used for the addition of Expansion Boards.

**Expansion Slot Connector:** Gold edge on the VGA 1024i that plugs into an expansion slot.

**Hercules Graphics Card (HGC):** A video adapter that provides bit mapped single color graphics.

**Hexadecimal Notation:** A base-16 numbering system that uses numbers and letters. The hexadecimal sequence begins: 1 2 3 4 5 6 7 8 9 A B C D E F, then 10, 11 etc.

**Horizontal Frequency:** The rate at which a monitor displays each scan line. Usually measured in kilohertz (KHz).

**I/O Port:** Input/Output port. An address used to access a hardware device. The VGA 1024i graphics controller can be accessed through I/O Ports 3CE and 3CF.

**Interlaced Display (ID):** A monitor that refreshes every other scan line every other pass of the screen. A non-interlaced monitor refreshes the entire screen (every scan line) every pass of the screen.

**Interrupt Request (IRQ):** Signal used by a device, such as a mouse, to inform the CPU that it is present and functioning.

**Jumper Shunt:** A small cap-like device that connects pins to select available options on an expansion board.

**Monochrome Display (MD):** Monitor that displays information in one color only.

**MDA:** The IBM Monochrome Display Adapter.

**Palette:** Total number of colors available to choose from. With VGA, the palette is 262,144 colors.

**Peripheral Equipment:** Auxiliary equipment connected to a computer (e.g. monitor, printer, keyboard, etc).

**Pixel:** Short for picture element; the smallest field displayed on the monitor; could be compared to the dots which form images in photos printed in newspapers. Also called *pel*.

**Primary Display:** The monitor that is active when you power on your system.

**PS/2 Display Adapter:** The IBM VGA board for Industry Standard Architecture (AT bus) computers.

**RAM:** Random Access Memory; memory that can be read from and written to.

**ROM:** Read Only Memory; memory space in your computer for storing permanent operating instructions.

**Resolution:** Number of pixels displayed on the monitor. The higher the resolution, the crisper and sharper the images appear.

**Secondary Display:** The monitor connected to the graphics card that is co-resident with another card/monitor in your computer system. Is not active upon booting your system.

**Terminate and Stay Resident (TSR):** Programs that are run once then remain in memory in order to be activated by a sequence of key strokes or a "hotkey." It is possible that a TSR may take up too much memory and cause conflicts with other programs.

***Variable Frequency Display (VFD):*** A monitor that is capable of displaying a wide range of resolutions due to its ability to scan at various horizontal and vertical frequencies.

***Vertical Frequency:*** The rate at which the monitor screen is refreshed. Usually measured in hertz (Hz).

***VGA:*** The IBM Video Graphics Array.

***Video Connector:*** The monitor connector located on the VGA 1024i. The VGA 1024i supports the standard IBM 15-pin analog output connector.

***Video Electronics Standards Association (VESA):*** An industry-wide consortium organized to improve graphics standards. The VGA 1024i supports the VESA 800 x 600 16-color standard.



## INDEX

- 3.5 inch disk format 5
- Address memory
  - Conflicts 18, 20, B-3, E-1
  - Locations used 18, E-1
- Alternate Parameter, See ALTPARM.COM
- ALTPARM.COM 24, 38, E-2
- ANSI G-1
- ANSI.SYS 23, 33
- ASCII E-4, G-1
- AT&T 6300 19
- AutoCAD
  - ADI configuration 43
  - Controlling resolution and colors 44
  - Dual screen mode 48
  - Installation 42
  - Resolutions supported 42
- AutoShade
  - ADI configuration 48
  - Resolutions supported 48
- Built-In Video 14, A-1
- CGA compatibility 28
- Clear Screen, See CLR.COM
- CLR.COM 24, 35
- Color Display A-1
- Color Graphics Adapter 27, A-1
- Columbia 1600 19
- Compaq
  - Deskpro 19
  - Portable 286 19
  - Portable 386 19
- Compatibility
  - Monitor 2
  - Software 2, 27
  - Software guarantee F-4
  - System 7, 19
- Compatibility modes
  - CGA 28
  - Hercules 28
  - Pure VGA 29
- Dell 19
- Diagnostics program, See V7DIAG.EXE
- DiamondScan 2
- Directory Listing, See DU.COM
- DU.COM 23, 34
- EGA compatibility 29
- Enhanced Color Display A-1, G-2
- Enhanced Graphics Adapter A-1
- Enhancement Selection, See ESU.COM
- Epson Equity 19
- ESU Menu 36
- ESU.COM 24, 36, 60, 62
- Flexscan 2
- GEM/3
  - Installation 49
  - Resolutions supported 49
- Generic CADD
  - Installation 51
  - Resolutions supported 51
- Hercules compatibility 28
- Hercules Graphics Card 27, 28, A-1, G-2
- Horizontal frequency D-2, E-2, G-2
- IBM
  - PC 19

- Portable 19
- IBM 8503 E-3
- IBM 8512 2
- IBM 8513 2, 41
- IBM 8514 2
- IBM AT 11, 12, 13, 18, E-1
- IBM PC 11, 12, E-1
- IBM PC/XT 11, 12, 13, E-1
- IBM XT/286 11, 12, 13
- IDS
  - AT 19
  - PC 19
- INSTALL.COM 21, 22
- Installation
  - Configuration 11
  - Preparation 10
- Interlaced Display G-2
- ITT Extra 19
- Jumper settings
  - E1 B-3
  - E2 B-3, E-2
- Kaypro 19
- Leading Edge
  - Model D 19
  - Model M 20
- Lotus 1-2-3
  - Installation 52
  - Resolutions supported 51
- Memory upgrade D-6
  - Installation of DRAM D-7
  - Type of DRAM D-6
- Mitsubishi 386 20
- Mode numbers D-3
- Monitor timings D-2
- Monochrome Display
  - A-1, G-3
- Monochrome Display
  - Adapter A-1, G-3
- Multiscan 2, 41, E-2
- MultiSync 2, 18, 41, E-2
- MultiSync 3D 2, 41, D-2

- MultiSync GS E-3
- Mylex 20
- P-CAD
  - Installation 53
  - Resolutions supported 53
- Pinouts
  - Feature Connector D-1
  - Monitor D-1
- PMINST.EXE 54
- Presentation Manager
  - Installation 54
  - Resolutions supported 54
- PS/2 Model 30 E-1
- RAMBIOS.SYS 22, 23, 24, E-4
  - Installation 25
  - When not to use 24
- RMA number F-3
- ROMDATE.COM 23, E-1
- Sample code fragments
  - D-4
- Screen Saver 21, 30, E-4
  - Changing the Time Value 31
  - Commands
    - NOSAVE 31, 32, 33
    - SAVE [n] 31
    - SAVE OFF 31, 32, 33
    - SAVE ON 31
  - Disabling 32
  - When not to use 30, 32
- Seiko CM-1430 2, 41, D-2
- SELECT.EXE 59
- Sperry
  - IT 20
  - PC 20
- Switch settings
  - Switch 4 B-1, E-2
  - Switch 5 B-2
  - Switch 6 20, B-2, E-2
  - Switch 7 B-2

Switch 8 B-3  
 Switches 1-3 B-1  
 Symphony  
   Installation 52  
   Resolutions supported 51  
 Tandy 1000 20  
 Technical Support  
   Bulletin Board Service F-1  
   Hours F-1  
 Toshiba 2300 20  
 V7ANSI.SYS 23, 33  
 V7DIAG.EXE 24, 37, D-7, E-4  
 V7INST.EXE 42, 44, 47  
 V7REL10.COM 42, 44, 47, 48, 49  
 V7VGA.COM 23, 26, E-4  
   CGA OFF 28, C-1  
   CGA ON 28, C-1  
   MONO FULL 29, C-1  
   MONO HALF 28, 29, C-1  
   MONO OFF 29, C-1  
   MONO ON 29, C-1  
   NOSAVE 31, C-1  
   PURE OFF 30, C-1  
   PURE ON 30, C-1  
   SAVE [n] 31, C-1  
   SAVE OFF 31, C-1  
   SAVE ON 31, C-1  
 V7VGA.COM Menu 26  
 Variable Frequency  
   Display G-4  
 Ventura Publisher  
   Installation 55  
   Resolutions supported 55  
 VersaCAD  
   Installation 56  
   Resolutions supported 55  
 Vertical frequency D-2, E-2, G-4  
 VESA 39, G-4  
 VGA compatibility 29  
 Video Graphics Array G-4  
 VPINST.EXE 55  
 Windows/286  
   Installation 57  
   Resolutions supported 57  
 Windows/386  
   Installation 59  
   Resolutions supported 58  
 WordPerfect  
   Installation 60  
   Resolutions supported 60  
 WordStar 3.3 61  
 WordStar Professional 62  
 Zenith  
   151/161 20  
   158 20  
 Zenith ZCM-1490 2, 41



# **HEADLAND TECHNOLOGY INC.**

## **Limited Warranty**

HEADLAND TECHNOLOGY INCORPORATED (Headland Technology) warrants this product against defects in material and workmanship for a period of seven (7) years from the date of purchase. During the warranty period, Headland Technology will repair, or at its option, replace this product at no charge.

This warranty does not apply if the product has been damaged by accident, abuse, misuse or misapplication, nor as a result of service or modification other than by Headland Technology.

HEADLAND TECHNOLOGY IS NOT RESPONSIBLE FOR INCIDENTAL OR CONSEQUENTIAL DAMAGES RESULTING FROM BREACH OF ANY EXPRESS OR IMPLIED WARRANTY, INCLUDING DAMAGE TO PROPERTY AND, TO THE EXTENT PERMITTED BY LAW, DAMAGES FOR PERSONAL INJURY. THIS WARRANTY IS IN LIEU OF ALL OTHER WARRANTIES INCLUDING IMPLIED WARRANTIES OF MERCHANTABILITY AND FITNESS FOR A PARTICULAR PURPOSE.

Some states do not allow limitation of implied warranties, or the exclusion or limitation of incidental or consequential damages, so that the above limitations or exclusions may not apply to you.

**HEADLAND TECHNOLOGY INC.**  
**46221 Landing Parkway**  
**Fremont, CA 94538**  
**(415) 623-7857**



---

# Customer Support And Registration

**VIDEO SEVEN  
VGA 1024i**

---

In order to help us provide the highest level of customer support, please complete and return the attached Registration Card.

When we receive it, we will add your name to our registered user database.

This will allow us to communicate with you regarding updates and new products.



