

**Matrox Graphics Architecture**

**MATROX**

# **Millennium**

## **Installation Guide**

10425-101-0310  
1997.02.04

**ENGLISH**



## Trademarks

---

*Matrox® is a registered trademark of Matrox Electronic Systems Ltd.*

*Matrox Millennium™, Matrox Mystique™, MGA™, MGA Millennium™, MGA PowerDoc™, MGA Impression™, MGA Impression Plus™, QCDP™, MGA DynaView™, PixelTOUCH™, CenterWINDOW™, PanLOCK™, ResSwitch™, ModeSWITCH™, MGA Control Panel™, QuickAccess™, MGA PowerDesk™, MGA Desktop Navigator™, DeskNav™ and MGA QuickDesk™ are trademarks of Matrox Graphics Inc.*

*Adobe™ and Acrobat™ are trademarks of Adobe Systems Inc.*

*IBM®, VGA®, and OS/2® are registered trademarks of International Business Machines Corporation.*

*Intel® and Pentium® are registered trademarks, and 486™ is a trademark of Intel Corporation.*

*Windows NT™, Windows 95™ and Windows for Workgroups™ are trademarks of Microsoft Corporation; Microsoft®, Windows® and MS-DOS® are registered trademarks of Microsoft Corporation.*

*AutoCAD® and 3D Studio® are registered trademarks of Autodesk Inc.*

*MicroStation™ is a trademark of Bentley Systems Inc.*

*RAMDAC™ is a trademark of Brooktree.*

*CompuServe® is a registered trademark of CompuServe Inc.*

*All other nationally and internationally recognized trademarks and tradenames are hereby acknowledged.*

THE INFORMATION CONTAINED IN THIS MANUAL IS SUBJECT TO CHANGE WITHOUT NOTICE AT ANY TIME.

© Copyright Matrox Graphics Inc., 1997. All rights reserved.

Disclaimer: Matrox Graphics Inc. reserves the right to make changes in specifications at any time and without notice. The information provided by this document is believed to be accurate and reliable. However, no responsibility is assumed by Matrox Graphics Inc. for its use; nor for any infringements of patents or other rights of third parties resulting from its use. No license is granted under any patents or patent rights of Matrox Graphics Inc.

---

# Contents

---

<i>Trademarks</i> .....	<i>ii</i>
<b>Overview</b>	<b>1</b>
Software supplied with the Matrox Millennium.....	1
Software installation .....	1
<b>Using this document</b>	<b>2</b>
On-line documentation .....	2
<b>Quick hardware installation</b>	<b>3</b>
<b>Windows 95 software</b>	<b>5</b>
Before installing MGA PowerDesk software for Windows 95 .....	6
Installing MGA PowerDesk software for Windows 95.....	7
Monitor settings .....	8
Display settings.....	9
MGA PowerDesk folder .....	9
On-line documentation .....	10
Microsoft® DirectX™ .....	10
<b>Windows 3.1 software</b>	<b>11</b>
Installation .....	11
DynaView 2D for Windows 3.1 .....	12
DynaView 3D for Windows 3.1 .....	12
DPMS Screen Saver for Windows 3.1 .....	13
DCI Video for Windows 3.1 accelerator .....	13
Uninstall.....	13

<b>Windows NT software</b>	<b>14</b>
Windows NT 4.0 driver installation.....	14
Windows NT 3.5 driver installation.....	14
Changing resolutions.....	15
MGA PowerDesk Control Panel.....	15
Monitor configuration .....	15
<b>OS/2 software</b>	<b>16</b>
Driver installation .....	16
Changing resolutions.....	16
MGA Settings utility.....	17
Monitor configuration .....	17
<b>AutoCAD and MicroStation for DOS software</b>	<b>18</b>
Installing the DOS Utilities and monitor selection .....	18
Installing the AutoCAD DynaView driver for DOS.....	18
Installing the MicroStation PC driver .....	19
CAD Software Documentation .....	19
<b>Supported VESA modes</b>	<b>20</b>
<b>Display information</b>	<b>21</b>
<b>Hardware information</b>	<b>23</b>
Hardware settings.....	24
Connector Pinouts .....	26
<b>Troubleshooting</b>	<b>27</b>

---

## Overview

---

The Millennium is a high-performance graphics card that plugs into a PCI expansion slot inside your personal computer. Matrox's 64-bit graphics engine gives you superior performance for Windows, 3D, digital video and DOS programs. You can also upgrade your Millennium card with more RAM or multimedia hardware add-ons.

The Matrox Millennium is 100% VGA compatible and supports all VESA standards: VBE 2.0 (Super VGA modes), DPMS (Energy saving), and DDC 2B (Plug-and-Play monitor).

## Software supplied with the Matrox Millennium

---

- **MGA PowerDesk for Windows 95:** Windows 95 drivers, DirectDraw (games driver) and a DirectVideo driver, **MGA Monitor** sheet, **MGA Settings** sheet, **MGA Color** sheet, **MGA Desktop Navigator** program and **MGA QuickDesk** applet
- **MGA PowerDesk and DynaView for Windows 3.1:** Windows drivers, MGA PowerDesk software, DCI video driver, 3D Screen Saver with DPMS functions, and AutoCAD driver for Windows
- Windows NT and OS/2 drivers
- DynaView drivers for AutoCAD for DOS, MicroStation 5.0 and MicroStation 95 (5.5) drivers, DOS utilities, on-line documentation, demos, utilities and games

## Software installation

---

All the software described in this manual can be installed from the Matrox CD-ROM. You can install most of the software using our main installation program:

- **Under Windows 95 & Windows NT 4.0:** The autorun feature will automatically start the *mgasetup* program when you insert the CD-ROM in your drive.
- **Under Windows 3.1:** Run *mgasetup* from the root directory of the CD-ROM.

Windows NT 3.5, OS/2 and CAD drivers can not be installed from the main installation program. For more information on installing each software product, see the appropriate section in this manual. For details on the CD-ROM's contents, see the *readme.lst* file in the root directory.

<p><b>NOTE:</b> This manual assumes that your CD-ROM drive letter is “d”. If your CD-ROM drive letter is different, replace “d” with the letter used on your computer.</p>
--

---

## Using this document

---

This manual assumes you're familiar with basic functions like click, right-click and double-click, and that you're familiar with the basics of the operating system you're using (Windows 95, 3.1, NT, OS/2 or DOS). In addition, we use the following conventions:

- **Bold** for text that appears on-screen and for **subheads**.
- *Italics* for file and path names, publication titles, and new terms.
- ***Bold Italic*** for emphasis.
- **Green** for cross-references.  
(When viewing online, click on green text to jump to the page being referenced.)
- Keyboard keys in square brackets, with a plus sign separating keys that you press simultaneously. For example: press [Ctrl]+[Alt]+[Del] to restart your computer.
- Directed arrows (“→”) to separate ordered directions.

For example:

Click **Start** button → **Programs** folder → **MGA PowerDesk** folder;

is the same as:

- 1** Click on the **Start** button.
- 2** Click on the **Programs** folder.
- 3** Click on the **MGA Powerdesk** folder.

---

## On-line documentation

---

We provide additional documentation in Help files, *readme* files, and Adobe™ Acrobat™ Portable Document Format (PDF) files. Use the **Acrobat Reader** program, which you can install from the Matrox CD-ROM, to view or print PDF files. This manual covers hardware and software installation and configuration, organized into one section per software product. For more information on the types of documentation we provide, refer to each software section.

---

# Quick hardware installation

---

## Warning!

*Static electricity* can severely damage electronic components. To be safe, take the following precautions to ground yourself before touching your Millennium card:

- 1 Turn off the power to all equipment, leaving it plugged in.
- 2 Touch the metal chassis of your computer to drain the static electricity from your body *before* you touch the card. Don't let your clothes touch any of the components.

## 1 Switch to the standard VGA driver

If you're running Windows 95 on your computer, this is not necessary. If you're running Windows 3.1, Windows NT or OS/2, refer to your operating system's documentation for how to switch to VGA mode.

## 2 Open your computer and remove your existing graphics card

Turn off your computer and all peripherals such as the monitor or printer. Once open, remove your existing graphics card. (If you have a display adapter built into your computer's motherboard, it should automatically disable itself after your Millennium card is installed.)

## 3 Choose a PCI expansion slot

Most PCI bus computers contain a combination of PCI and ISA expansion slots. PCI slots are usually made with plastic of a contrasting beige color, and are shorter than other slots in your computer. Your system manual should identify the PCI slots. Plugging your Millennium card into a non-PCI slot could damage the card, your computer, or both.

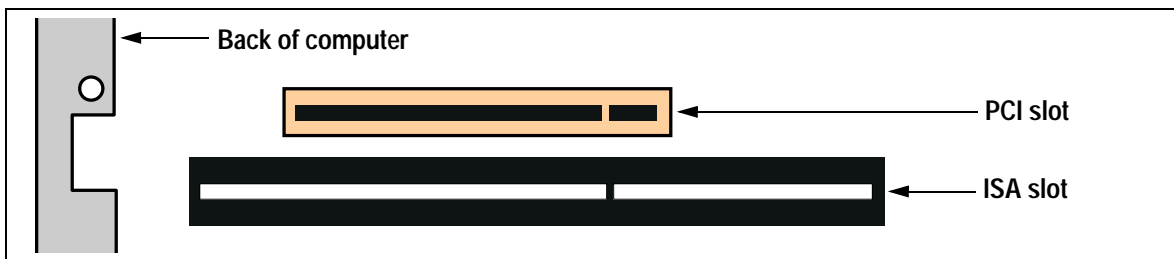

PCI vs. ISA expansion slots

#### 4 Plug the Millennium card in

Remove the cover for the slot you intend to use. Save the screw for the mounting bracket. Ground yourself, then pick up the Millennium card and position it over the expansion slot you've chosen. Push the card in firmly and evenly until it's fully seated in the slot. Replace the screw to secure the bracket of the Millennium card to the computer chassis.

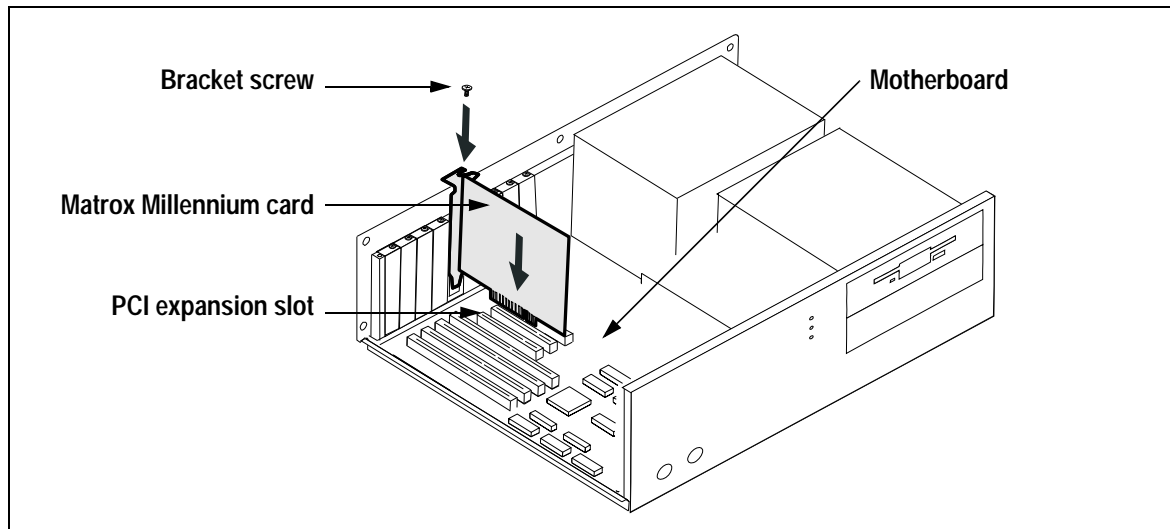

#### 5 Connect the monitor

Simply plug your monitor cable into the 15-pin video output connector on your Millennium. You should have an analog multisync RGB (Red, Green, Blue) monitor that supports separate vertical and horizontal sync. The Matrox Millennium can display all VGA and better resolutions from  $640 \times 480$  to  $1600 \times 1200$ , at vertical frequencies from 60 to 200 Hz. See [“Display information” on page 21](#) for details about monitor configuration.



---

## Windows 95 software

---

*Do not use the MGA driver provided by Windows 95.* It does not support MGA PowerDesk. Use the driver supplied on the Matrox CD-ROM.

### MGA PowerDesk software for Windows 95 includes:

- **Display driver** for Matrox Mystique and Matrox Millennium (Fast!)
- **DirectDraw/DirectVideo/Direct3D** driver (Faster games and video!)
- **DDC-2b and Windows 95** monitor support (Plug and Play!)
- **MGA Monitor** sheet lets you change your monitor settings. It lets you optimize the settings for your monitor through interactive testing and adjustment. You can use this sheet in place of the standard Windows 95 monitor selection process. The setup program adds this sheet to the Windows 95 **Display Properties** dialog box.
- **MGA Settings** sheet lets you change your display settings. The setup program adds this sheet to the Windows 95 **Display Properties** dialog box. This sheet provides access to MGA PowerDesk features such as:
  - **Desktop Mode buttons** to configure a desktop area of varied shapes (proportional, horizontal, vertical) that goes beyond the limits of the display.
  - MGA PowerDesk hot key settings for:
    - PixelTOUCH** to zoom (×2 and ×4) and pan in your view area.
    - PanLOCK** to lock the view area of your virtual desktop.
    - CenterWINDOW** to bring the active dialog box or program window into your view area.
  - **Display Schemes** to easily switch between your pre-defined display settings.
  - **Information** sheet to display hardware and software version numbers and capabilities.
  - **Performance** sheet to configure driver performance settings.
- **MGA Color** sheet lets you change your display's color balance. The setup program adds this sheet to the Windows 95 **Display Properties** dialog box.
- **MGA Desktop Navigator** program lets you quickly change the view area of your desktop and gives you quick access to the PixelTOUCH zoom, PanLOCK and CenterWINDOW features.
- **MGA QuickDesk** applet lets you quickly switch between your saved display schemes, open the **Display Properties** dialog box or launch **MGA Desktop Navigator**. It presents itself as a monitor icon in the right corner of the Windows 95 taskbar.

## Before installing MGA PowerDesk software for Windows 95

- If you're installing PowerDesk for Windows 95 for the first time, select the description below that applies to you and follow the pre-installation steps.

### If you're running Windows 95

- 1 If your Millennium card is not already installed, turn off your system and install it. See [“Quick hardware installation” on page 3](#) for complete instructions on this procedure.
- 2 Restart your computer.
- 3 After restarting, Windows 95 will be in standard VGA mode (640 × 480 resolution, 16 colors) and will report it has found new hardware:

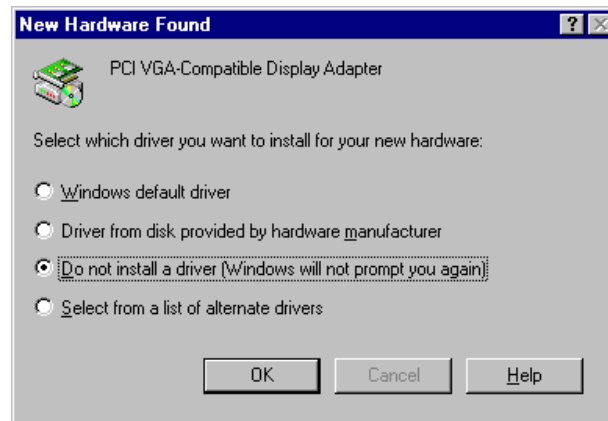

Choose the **“Do not install a driver”** option. Later, you install the drivers *and* MGA PowerDesk software at the same time. (If you prefer, you can install the drivers immediately from the Matrox CD-ROM, but you should still install the MGA PowerDesk software later.)

- 4 Go to [“Installing MGA PowerDesk software for Windows 95” on page 7](#) and follow the instructions.

### If you're upgrading to Windows 95 from Windows 3.1

- 1 Switch to **VGA** display mode through the Windows 3.1 **Windows Setup** program.
- 2 If Windows 3.1 MGA PowerDesk is installed on your system, remove it using the **MGA Uninstallation** program in the MGA PowerDesk group window.
- 3 If your Millennium card is not already installed, turn off your system and install it. See [“Quick hardware installation” on page 3](#) for complete instructions on this procedure.
- 4 Restart your computer.
- 5 Run the Windows 95 *setup* program to install Windows 95.

During Windows 95 installation, a hardware detection process will detect an **Oak Technology Super VGA** card. There's no cause for alarm – your computer will restart in standard VGA mode (640 × 480 resolution with 16 colors), which is supported by the

Matrox Millennium. After installing Windows 95, follow the instructions in the next section.

## Installing MGA PowerDesk software for Windows 95

---

This section assumes you've followed the instructions in the preceding section.

- 1 Insert the Matrox CD-ROM in your CD-ROM drive.  
(Windows 95's autorun feature will start the *mgasetup* program.)
- 2 Click on **MGA PowerDesk for Windows 95** → **Install** to launch the PowerDesk *setup* program.  
(The other install options are covered later in this manual and in the CD-ROM booklet.)
- 3 Select the language version of MGA PowerDesk you want to install and click on **Next**.
- 4 Click **Typical** to install the complete MGA PowerDesk (recommended), or click **Custom** to customize the installation.

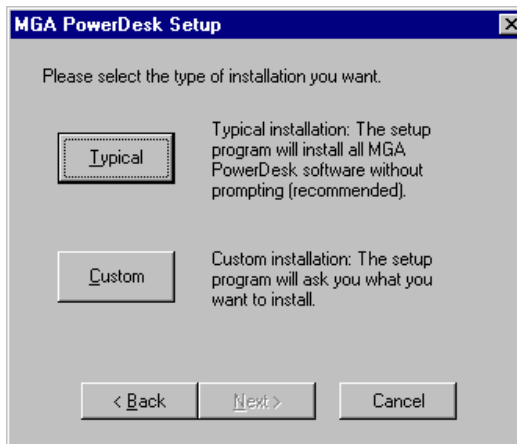

If you click **Custom**, you'll be prompted for a destination directory and what options you want to install.

- 5 After the *setup* program copies files to your hard disk, it will *automatically* change the display adapter type to MGA mode. This is done through the Windows 95 **Display Properties** dialog box. (This does not apply if you're upgrading from an earlier version of our Windows 95 drivers.) After installation, restart your computer for all changes to take effect.

After restarting your computer, your display will be at 640 × 480 resolution with 256 colors (unless you were upgrading from an older MGA PowerDesk for Windows 95).

## Monitor settings

---

If you have a Plug-and-Play (DDC) monitor, the MGA driver will *automatically* use the correct settings for your monitor.

If you do *not* have a Plug-and-Play monitor, check in the Windows 95 **Display Properties** dialog box to see if a monitor is selected:

- 1 Right-click on the Windows 95 desktop background.
- 2 Click on the **Properties** menu item → **MGA Monitor** tab.

If your **Monitor Type** is **Windows 95 Monitor: (Unknown Monitor)**, you should select a monitor. You can do this with the **MGA Monitor** option button.

MGA PowerDesk also supports the Windows 95 method of monitor selection. Windows 95 monitor selection is done through the **Display Properties** dialog box → **Settings** tab → **Change Display Type** button. MGA PowerDesk will use video timings that best match the frequency ranges reported by the Windows 95 monitor selection.

For more information on selecting a monitor profile, see MGA PowerDesk's on-line documentation.

**WARNING:** Selecting the wrong monitor in the software can damage *some* monitors. See your monitor manual for more information.

## Display settings

---

Once you've confirmed that the software monitor settings are correct, you can change your display resolution, color palette and other MGA PowerDesk settings through the Windows 95 **Display Properties** dialog box:

- 1 Right-click on the Windows 95 desktop background.
- 2 Click on the **Properties** menu item → **MGA Settings** tab.

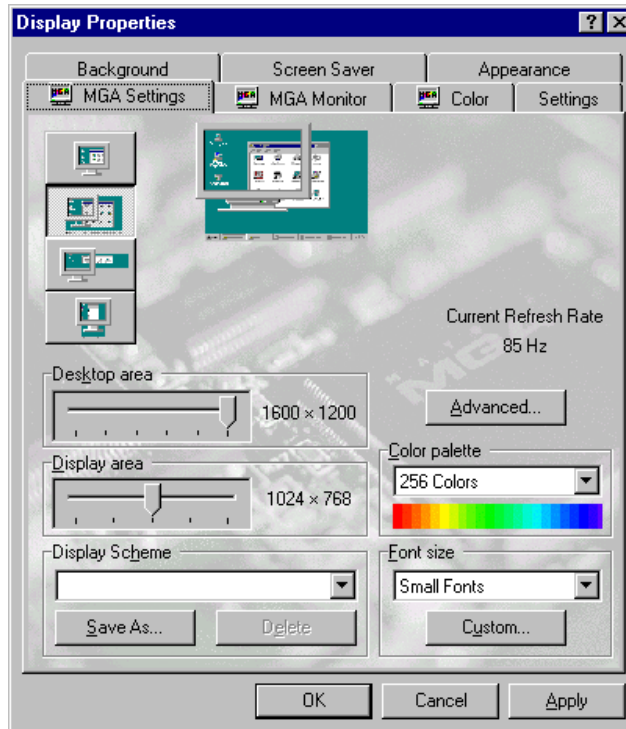

For more information on changing your display settings, see MGA PowerDesk's on-line documentation.

## MGA PowerDesk folder

---

The **MGA PowerDesk** folder is created by the *setup* program in **Start menu** → **Programs** folder. This folder gives you access to **MGA Desktop Navigator** program, **MGA QuickDesk** applet, **On-line doc** file and **readme** file. There's also the **MGA Diagnostic** program which you can use to identify some potential problems with your system.

## On-line documentation

---

- You can access *MGA PowerDesk for Windows 95* on-line documentation through the **MGA PowerDesk** folder.
- A *readme* file is also in the MGA PowerDesk folder.
- For context sensitive help where available, press [F1] or click the “?” icon in the title bar and then the item you want help on.

## Microsoft® DirectX™

---

MGA PowerDesk for Windows 95 supports *DirectDraw*, *DirectVideo* and *Direct3D*. These interfaces (and others such as *DirectSound* and *DirectInput*) are collectively referred to as *DirectX*. DirectX was developed by Microsoft so that programs could support advanced hardware features without being written specifically for each hardware model. Programs that use DirectX use the Microsoft DirectX interface, which in turn uses the MGA DirectDraw driver, which supports DirectVideo and Direct3D. The DirectX interface is in the form of Dynamic Link Library (DLL) files.

### DirectX installation required!

The Microsoft DirectX interface *must* be installed to ensure that programs that use DirectX function correctly and so these programs can benefit from Matrox hardware acceleration. Many programs install DirectX as part of their installation procedure. Check the **Display Properties** dialog box → **MGA Settings** tab → **Advanced** button → **Information** tab → **Microsoft DirectX Version** label to see if Microsoft DirectX is present, and if it is, to see the version number. **To install Microsoft DirectX:**

- 1 Insert the Matrox CD-ROM in your CD-ROM drive.  
(Windows 95's autorun feature will start the *mgasetup* program.)
  - 2 Click on **Microsoft DirectX** list item → **Install** button → **Next** button to begin installation.
  - 3 Click on **Reboot** to restart your computer and for the changes to take effect.
- ◆ Depending on the version of Microsoft DirectX on your CD-ROM, you may have to install **Microsoft DirectVideo** separately. If it appears in the *mgasetup* list, install it as well.

### Direct3D limitations

The Matrox Millennium is a high performance graphics card that provides acceleration for 3D rendering in hardware. The Millennium accelerates 3D operations such as flat and Gouraud shading, Z-buffering, and color dithering in hardware. However, the Millennium does *not* provide full support for 3D texture mapping in hardware. As a result, programs that require the use of texture mapping and other more complex 3D functions will use the Millennium's fast 2D acceleration, and your computer's CPU will perform rendering.

Programs that require only those 3D features supported by Millennium – including many CAD and multimedia programs – will be fully 3D accelerated in hardware by the Millennium.

---

# Windows 3.1 software

---

The Windows 3.1 product contains drivers, MGA PowerDesk utilities, a monitor file, a Screen Saver and a DCI driver, as well as DynaView 2D and 3D for Windows.

## Installation

---

- 1 Start Windows in VGA resolution and put the Matrox CD-ROM in drive *d:*. Select **File** → **Run** in Program Manager. Type *d:\win31\setup* in the **Command Line** box.
- 2 You will be prompted for the products to install: Windows Drivers and PowerDesk (including Screen Saver and DCI), DynaView for Windows, or both. Do not select DynaView for Windows if you don't have AutoCAD for Windows installed.  
If you select DynaView for Windows, you will be prompted for the specific products to install: DynaView 2D for Rel. 12, DynaView 3D for Rel. 13 and/or DynaView 3D.
- 3 Once you have selected what you want to install, the installation program will prompt you for the various paths in which to install each product. Next, the MGA software installation program will run (bar graphs indicate the progress of the installation). A new Windows group called **MGA PowerDesk** will be created.

### Select a monitor

- 4 If this is a first time-installation, the **Monitor Selection** program will ask you to select an appropriate monitor. If your monitor is Plug-and-Play (VESA DDC-compliant), you won't have to specify a monitor; otherwise, please select one at this point to prevent the driver from starting up in a resolution not supported by your monitor. The Monitor Selection program is explained in its Help file (click on the **Help** button in the program).
- ◆ If you are updating one of our older drivers, then the **Monitor Selection** program will not start, but the installation program will ask you if you wish to keep your present *mga.mon* file, in case you have customized the file for a particular monitor. If you have not customized the *mga.mon* file, click on **YES** to overwrite it with the new version.

### Select a start-up mode

- 5 Next you must select a start-up display mode for Windows. The range of resolutions and colors available to you is limited by the amount of RAM on your Millennium card. Choose a combination of one of the available resolutions and pixel depths. You are indicating to the MGA software how it should present Windows the first time you run it. Later, you'll be able to make the same kind of selections using the **MGA Control Panel** program.

### Rebooting

- 6 After you click on the **OK** button in the **Startup Display Mode** dialog box, the installation program will either reboot your system (in the case of a first-time installation) or reboot

Windows (in the case of an upgrade). Rebooting the system on a first-time installation is essential to set the MGA environmental variable (see below).

- ◆ An **MGA environment variable** is automatically added to your *autoexec.bat* file by the installation program. Make sure you don't delete the *set mga=c:\mga\setup* line from your *autoexec.bat* file. If you delete this variable setting, your Millennium card will lose track of any customized configuration done by the monitor selection program.

## Windows 3.1 software documentation

The MGA PowerDesk for Windows 3.1 documentation is provided in electronic format on the Matrox CD-ROM in the form of an Adobe Acrobat Portable Document Format (PDF) file. The **Acrobat Reader** for PDF files can be installed to your system from the Matrox CD-ROM.

With the Acrobat Reader, you can open and read a PDF document, search for any word in a document, and even print the document on your printer. From within Acrobat, see **Help → Acrobat Reader Help** for complete instructions on how to use the program.

### To install the documentation files:

- 1 From the **Program Manager**, select **File → Run**, and then enter *d:mga\setup* in the command line text box.
- 2 Select: **MGA PowerDesk & Millennium Installation Guides → Install**

The installation program will install two PDF files and create two icons in your MGA PowerDesk group: one for the **MGA PowerDesk Guide**, and one for the **Millennium Installation Guide** (a PDF version of this manual).

Note that more information is also available in the *readme.win* file, and in many Help files provided with the various PowerDesk programs. A Notepad icon titled **Readme.Win** is created in the MGA PowerDesk group window.

## DynaView 2D for Windows 3.1

---

The default path for AutoCAD for Windows drivers is *C:\acadwin* for Rel. 12 and *C:\acadr13\win* for Rel. 13. Make sure you indicate the path where your AutoCAD software is actually installed, otherwise the MGA driver will not be found by AutoCAD.

Read the *readme.mga* file in your destination path for information on configuring the MGA driver. The DynaView 2D driver comes with a Bird's Eye utility. To call it, type *dsvviewer* from within AutoCAD 12, or *dynaview* from within AutoCAD 13. On-line Help is available for DynaView 2D; just press the **Help** button.

## DynaView 3D for Windows 3.1

---

This product comes in two parts: the 3D Viewer program and the ADS program. The installation adds an icon for the 3D Viewer (and its associated *readme* file) in the MGA PowerDesk group. For the 3D Viewer to display Gouraud shading, the Matrox Millennium Windows driver must be "3D-enabled". To do this, start **MGA Control Panel** and select a display mode that will allow you to



enable the **3D** check box. Note that with 3D enabled, the available range of resolutions and pixel depths is reduced. On-line Help is available for DynaView 3D; just press the **Help** button.

- ◆ **Note:** The Matrox ADS application included with DynaView 3D for Windows may have problems loading or finding the right source files if you don't install the product in the default *c:\mga\dyna3dw* directory.

If you installed the application in a different directory or on a different hard drive, the complete file path must be specified in the file *3dadsw12.mnu* (for AutoCAD Rel. 12), or *3dadsw13.mnu* (for AutoCAD Rel. 13).

That is, the correct path must exist at every location where the *XLOAD* and *XUNLOAD* statements appear.

## DPMS Screen Saver for Windows 3.1

---

The MGA Screen Saver displays 3D images created with the DynaView 3D software. A few 3D images are also included on the Matrox CD-ROM. The Screen Saver supports DPMS, for EnergyStar-compatible monitors.

You must select **MGA 3D** from the list in the **Screen Saver** panel shown in the Windows **Control Panel** → **Desktop** applet. On-line help can be accessed by clicking on the **Help** button.

## DCI Video for Windows 3.1 accelerator

---

The MGA DCI (Display Control Interface) driver is a Microsoft/Intel compliant driver which accelerates MPEG software players, as well as playback of **Video for Windows 1.1**. The DCI driver and some upgrade files for Video for Windows will be installed in your *windows\system* directory. You must be using "DCI-aware" codecs in order to have video window acceleration. See the *readme.win* file for a list of known DCI-aware applications. If necessary, you can install our **Video for Windows 1.1e** runtime files from the Matrox CD-ROM.

The DCI driver is always installed by the installation program, but is enabled at your request only. It can later be disabled through the uninstall utility.

## Uninstall

---

This program allows removal or disabling (and later re-enabling) of all or parts of the MGA PowerDesk for Windows 3.1 and DynaView software. It is accessible from the MGA PowerDesk group. If you're upgrading from Windows 3.1 to Windows 95 and your Millennium was installed with drivers for Windows 3.1, you must first **uninstall** the Windows 3.1 MGA PowerDesk software. See the on-line documentation for more information.

---

## Windows NT software

---

The MGA Windows NT Display Driver supports 8-bit (256 colors), 15-bit (32 K colors), 16-bit (64 K colors), 24-bit (16.7 M colors), and 32-bit (true color) display modes under Windows NT 3.5 and 4.0, in resolutions ranging from 640 × 480 to 1600 × 1200. This driver also supports multiple Matrox Millennium configurations, and comes with a PowerDesk control panel called **MGA Panel**. For more information about the driver, refer to *readme.nt* on the Matrox CD-ROM.

---

### Windows NT 4.0 driver installation

---

- 1 Insert the Matrox CD-ROM in your CD-ROM drive.  
(Windows NT's autorun feature will start the *mgasetup* program.)
- 2 Click on **MGA PowerDesk for Windows NT 4.0** list item → **Install** button to start the PowerDesk *setup* program.
- 3 The *setup* program will ask you if you want to install MGA PowerDesk (see “**MGA PowerDesk Control Panel**”, page 15) and drivers, or if you want to install *only* the drivers. Make your choice and click **Install** to begin the installation.
- 4 The *setup* program will *automatically* change the display adapter type to MGA mode. This is done through the Windows NT **Display Properties** dialog box. You'll be prompted to restart your system at the end of the installation procedure. Click **Yes** for the changes to take effect.

---

### Windows NT 3.5 driver installation

---

- 1 Open the **Control Panel** → **Display** applet in Windows NT.
- 2 Click on the **Change Display Type** button.
- 3 In the **Display Type** dialog box, click on the **Change** button.
- 4 In the **Select Device** dialog box, click on the **Other** button.
- 5 In the **Install From Disk** dialog box, type *d:\winnt\* for the Matrox CD-ROM.
- 6 From the displayed list, select a resolution and pixel depth that are supported by your Millennium card and monitor, then select **Install**. Refer to “**Display information**” on page 21 to determine the supported resolution and pixel depth combinations.
- 7 Answer **Yes** in the **Installing the Driver** dialog box.
- 8 If Millennium drivers are already installed on your system, you will be prompted to choose between the currently installed drivers or new ones. If you select **New**, you will be prompted for the path to the new driver files. By default, this is the path that was entered in the **Install From Disk** dialog box.
- 9 In the **Display Settings Change** dialog box, you should select **Restart Now** in order for the new settings to take effect.

If your system does not reboot at the expected resolution, the Millennium card may not support the selected resolution and/or pixel depth combination. Open the **Control Panel → Display** applet again and click on the **List All Modes** button to obtain a list of all the modes that are available for your Millennium card. You can also experiment with the **Color Palette** and **Desktop Area** controls to select a new mode. Use the **Test** button to ensure that the new mode is supported by your monitor.

## Changing resolutions

---

To change the display resolution: In Windows NT 4.0, right-click on the desktop background for the **Display Properties** dialog box, and then click on the **Settings** tab. In Windows NT 3.5, run the **Control Panel → Display** applet. (To see the available modes, click on the **List All Modes** button.)

The current version of the driver supports multiple Millennium cards, enabling use of a single large desktop which spans multiple monitors. The multi-card modes that are supported by your hardware configuration can be selected and tested (as with any regular mode) using the **Display** applet.

## MGA PowerDesk Control Panel

---

MGA PowerDesk includes:

- **MGA Panel**, a Control Panel applet which provides information about your Millennium card and driver, and allows configuration of PowerDesk hot keys, 3D acceleration options, and monitors.
- **Quick Access**, a floating toolbar which allows easy access to PowerDesk features such as hardware zoom and window centering.

To access the PowerDesk features, run the Windows NT **Control Panel** and double-click on the **MGA Panel** icon. See the on-line Help file for more information about **MGA Panel**.

## Monitor configuration

---

If your monitor is Plug-and-Play (VESA DDC-compliant) the driver will automatically use an appropriate refresh rate. If not, our driver will use the default refresh rate of 60 Hz, unless you specify a monitor using our **MGA Panel** application. To do this:

- 1** Open the **Control Panel → MGA Panel** applet, and select the monitor page.
- 2** From the list of monitors, select the appropriate monitor, or one whose maximum refresh rate matches the one you're using. An *mga.inf* file will be created in the *system32* subdirectory of your Windows NT directory.
- 3** Restart Windows NT for the new settings to take effect.

---

## OS/2 software

---

This MGA OS/2 PM driver supports 256 colors, 64 K colors and 16 M colors display modes under OS/2 2.1 up to “Warp”, in resolutions ranging from 640 × 480 to 1600 × 1200. The driver also includes a Seamless Windows driver and the **MGA Settings** utility. For more information about this driver (including uninstalling), refer to the *readme.os2* file on the Matrox CD-ROM.

### Driver installation

---

- 1 Restart your computer in standard VGA mode:
  - a During startup, press [Alt]+[F1] when “**OS/2**” appears in the top-left corner of your screen.
  - b From the on-screen menu, choose to restart in VGA mode.
- 2 Insert the Matrox CD-ROM in your CD-ROM drive. Using the **Presentation Manager** of OS/2, open the **OS/2 System** → **Icon View** window, and click on **Drives**.
- 3 Double-click on the icon for your CD-ROM drive, double-click on the *os2* subdirectory, then double-click on the *install.cmd* file.
- 4 You will see a dialog box in which you can select the **Primary Display**. Choose **Matrox MGA Millennium**.
- 5 The installation program will then proceed. When it is complete, you will have to shut down your system in order for the MGA driver to take effect.

If you are installing this driver for the first time, OS/2 will restart in the default MGA resolution (640 × 480 × 256 colors).

### Changing resolutions

---

To change the driver mode (resolution or pixel depth), use the following procedure:

- 1 Click the right button on the PM desktop background.
- 2 Select **System Setup** to open the system setup folder.
- 3 Double-click on the **System** icon.
- 4 Select the **Screen** tab and choose the resolution/pixel depth.
- 5 Restart your computer for the change to take effect.

## MGA Settings utility

---

With MGA Settings you can select a monitor and configure various driver parameters such as font size, EnDIVE (Enhanced Direct Interface Video Extensions), and a hardware zoom hot key, as well as view an information page.

The MGA Settings notebook is available from the **System Setup** folder, or directly from your desktop by clicking on the **MGA Settings** icon.

## Monitor configuration

---

If your monitor is Plug-and-Play (VESA DDC-compliant) the driver will automatically use an appropriate refresh rate. If not, our driver will use the default refresh rate of 60 Hz, unless you specify a monitor using our **MGA Settings** utility. This program creates a file called *mga.inf*, which contains the appropriate video parameters for your monitor. The *mga.inf* file is read by the MGA display driver when OS/2 boots.

---

## AutoCAD and MicroStation for DOS software

---

This section covers the MGA DOS drivers and utilities available on the Matrox CD-ROM in the following directories:

- *setup* (for DOS utilities)
- *acad* (for DOS AutoCAD DynaView drivers)
- *ustat* (for MicroStation PC drivers)

---

### Installing the DOS Utilities and monitor selection

---

This selection installs the Flash EPROM programming utility, the DOS monitor selection program, and the *vbetsr* and *vbsetup* utilities:

- The *progbios* Flash EPROM utility is necessary if your EPROM needs to be reprogrammed or updated.
- The *mgamon* monitor selection program can be used to select a monitor for the CAD drivers.
- The *vbetsr* and *vbsetup* utilities will allow you to run VESA Super VGA modes at high refresh rates.

When you select this option, you are prompted for the following information:

- 1 The install path (the default path is *c:\mga\setup*).
- 2 Your boot drive (the default is “c:”).
- 3 See the *readme.set* file for more details on the software, the BIOS DPMS, DDC, and VESA support (including *vbetsr* and *vbsetup*).

---

### Installing the AutoCAD DynaView driver for DOS

---

This selection installs the AutoCAD for DOS driver with its DynaView 2D and 3D features. Install this if you have AutoCAD 12 or 13 for DOS. This driver also supports 3D Studio.

When you select this option, you’re prompted for:

- 1 The installation path (*c:\mga\acadrv* is the default).
- 2 The AutoCAD product you want to run: AutoCAD 12 or 13 for DOS.
- 3 You’ll be asked if you wish to run *acadrv.bat* from your *autoexec.bat* file. If you do not place this call in your *autoexec.bat* file, you’ll have to remember to run *acadrv.bat* before starting AutoCAD, as it sets environment variables necessary for the driver and AutoCAD.
- 4 See the *MGA CAD Drivers Guide* (provided as a PDF file) for details on how to configure AutoCAD to use our driver and how to use the DynaView for DOS features.

Refer to the Matrox *readme.aca* file installed in *mga\acadrv* for instructions on configuring the driver for AutoShade and 3D Studio.

## Installing the MicroStation PC driver

---

This selection installs the MicroStation PC driver for MicroStation 5.0 and MicroStation 95. MicroStation 4.0 is not supported by this driver.

- 1 The default installation path for the files is *c:\ustation*. Change the path if you installed MicroStation in another directory. Press [Enter] to continue, and the driver files will be copied to the *drivers* subdirectory.
- 2 See the *MGA CAD Drivers Guide* (provided as a PDF file) for instructions on selecting and configuring the MicroStation driver. See also the *readme.mga* file in your *ustation\driver* subdirectory for more information on the driver.

## CAD Software Documentation

---

The MGA CAD drivers documentation is provided in electronic format as an Adobe Acrobat Portable Document Format (PDF) file. We also provide **Acrobat Reader** for DOS. Acrobat for DOS supports VESA Super VGA modes, allowing you to view the documentation in high resolution, and it also supports all popular printers, allowing you to print the manual. The documentation can be accessed from within an AutoCAD DOS shell, making it a real “on-line” help tool. The same PDF file can also be read with the Acrobat Reader for Windows, which is installed with the MGA PowerDesk documentation. The documentation can be installed from Windows or DOS:

### To install from Windows 3.1:

- 1 From the **Program Manager**, select **File** → **Run**, and then enter *d:mgasetup* in the command line text box.
  - 2 Select: **MGA CAD Users Guide** → **Install**
- ◆ To perform the installation under DOS, see the *readme.lst* file in the root directory of the CD-ROM for more details.

---

## Supported VESA modes

---

The Matrox Millennium video BIOS supports DOS VESA Super VGA applications and games in the modes listed with a VESA mode number in the table below:

Resolution	16 Colors	256 Colors	32 K Colors	64 K Colors	16.8M Colors
640 x 400	—	100	—	—	—
640 x 480	—	101	110	111	112
800 x 600	102	103	113	114	115
1024 x 768	—	105	116	117	118 <sup>1</sup>
1280 x 1024	—	107	119 <sup>1</sup>	11A <sup>1</sup>	—
1600 x 1200	—	11C	11D <sup>1</sup>	11E <sup>1</sup>	—

1. Requires 4 MB memory

Note that DOS applications that require a VESA mode are not supported by the Millennium Windows 3.1 driver in a DOS full-screen session when the **Device Bitmaps** acceleration feature is enabled. You can disable the **Device Bitmaps** feature in the **MGA Control Panel** → **Advanced Setup** dialog box.

### Using *vbetsr.com* and *vbsetup.exe*

The default vertical refresh rate for all VESA modes is 60 Hz. The *vbetsr* and *vbsetup* utilities can be used to obtain higher refresh rates, the same as obtained with your Matrox PowerDrivers. Use the following procedure to run *vbetsr* and *vbsetup* on your system:

- 1 Select a monitor with one of the Matrox Monitor programs.
- 2 Add calls to *vbetsr* and *vbsetup* (in that order) in your *autoexec.bat* file (*vbetsr* and *vbsetup* also support DDC monitors).

Now you can run your VESA Super VGA-compatible applications at the highest refresh rates supported by your monitor.



## Display information

The following tables provide information on supported resolutions, pixel depths (colors), maximum Desktop, 3D, and refresh rates for the various Millennium cards and memory upgrades.

### Resolution, Pixel Depth, and Maximum Refresh Rates

Resolution	Bits/Pixel (2 MB)	Bits/Pixel (4 MB)	Bits/Pixel (8 MB)	Maximum Refresh <sup>1</sup>	
				175 MHz board	220 MHz board
640 x 480	8, 16, 24, 32	8, 16, 24, 32	8, 16, 24, 32	120 Hz	200 Hz
800 x 600	8, 16, 24, 32	8, 16, 24, 32	8, 16, 24, 32	120 Hz	200 Hz
1024 x 768	8, 16	8, 16, 24, 32	8, 16, 24, 32	120 Hz	130 Hz
1152 x 864 <sup>2</sup>	8, 16	8, 16, 24, 32	8, 16, 24, 32	110 Hz	110 Hz
1280 x 1024	8	8, 16, 24	8, 16, 24, 32	100 Hz	100 Hz
1600 x 1200	8	8, 16	8, 16, 24 <sup>3</sup>	72 Hz	85 Hz <sup>4</sup>

1. To determine the speed of your RAMDAC, check your product name in the “[Hardware information](#)” section on [page 23](#), or run one of the following programs: Windows 3.1 – Board Information; Windows 95 – MGA Property Sheet; Windows NT – MGA Panel; DOS – setup program.
2. Some drivers support 1152 × 882 instead of 1152 × 864.
3. 24 bits per pixel has a maximum refresh rate of 72 Hz.
4. Highest supported VESA refresh rate at 1600 × 1200 is 80 Hz.

### PowerDriver Modes – Maximum Windows Display and 3D Capabilities

Millennium Memory	Bits Per Pixel	Max. Display	Max. Real-time 3D	3D Capabilities <sup>1</sup>
2 MB	8	1600 x 1200	800 x 600 <sup>2</sup>	800 x 600 <sup>2</sup>
	16	1152 x 864	640 x 480	800 x 600
	24	800 x 600	—	—
	32	800 x 600	—	640 x 480
4 MB <sup>3</sup>	8	1600 x 1200	1152 x 864 <sup>2</sup>	1280 x 1024 <sup>2</sup>
	16	1600 x 1200	800 x 600	1152 x 864
	24	1280 x 1024	—	—
	32	1152 x 864	640 x 480	800 x 600
8 MB <sup>3</sup>	8 <sup>2</sup>	1600 x 1200	1600 x 1200 <sup>2</sup>	1600 x 1200 <sup>2</sup>
	16	1600 x 1200	1280 x 1024	1600 x 1200
	24	1600 x 1200	—	—
	32	1280 x 1024	1024 x 768	1280 x 1024

1. AutoCAD and Microstation for DOS drivers only.
2. 8 bits per pixel only supported by Windows 3.1 drivers through ModeSWITCH.
3. Refer to [page 23](#) for a list of the available memory upgrade configurations.

## Plug-and-Play monitor support

Plug-and-Play monitors are VESA DDC-2B compliant. DDC monitors send their timing parameters to the Millennium card, which then uses the appropriate timings for each resolution.

Many DDC monitors do not report that they are capable of  $1152 \times 864$  or  $1600 \times 1200$  resolutions. To use these resolutions, or to use higher refresh rates or timings than those reported by the monitor to the Millennium card, use the MGA monitor selection method. See the *MGA PowerDesk for Windows (3.1 or 95)* on-line documentation for more information.

---

# Hardware information

---

## Global information

- Products:
  - MGA-MIL/2N: (U.S.A.) 220 MHz RAMDAC, with 2 MB memory
  - MGA-MIL/2I: (International) 220 MHz RAMDAC, with 2 MB memory
  - MGA-MIL/4N: (U.S.A.) 220 MHz RAMDAC, with 4 MB memory
  - MGA-MIL/4I: (International) 220 MHz RAMDAC, with 4 MB memory
  - MGA-MIL/2BN: (U.S.A.) 175 MHz RAMDAC, with 2 MB memory
  - MGA-MIL/2B: (International) 175 MHz RAMDAC, with 2 MB memory
  - MGA-MIL/4B: (U.S.A.) 220 MHz RAMDAC, with 4 MB memory
  - MGA-MIL/4BN: (International) 220 MHz RAMDAC, with 4 MB memory
- Memory upgrades:
  - MGA-MIL/MOD2: 2 MB Memory upgrade – 2 MB boards only (4 MB total)
  - MGA-MIL/MOD4: 4 MB Memory upgrade – 4 MB boards only (8 MB total)
  - MGA-MIL/MOD6: 6 MB Memory upgrade – 2 MB boards only (8 MB total)
- Technical features:
  - 64-bit VGA-compatible drawing engine
  - TVP 3026 (220 or 175 MHz) 64-bit RAMDAC
  - Separate sync monitors only

## Default settings

- Boot video mode/resolution: VGA Mode 3 (80 characters, 25 lines)
- Memory map: System-determined

## Electrical Specifications

- Operating voltage and current:
  - 0.9 A typical with no module
  - 1.1 A with 2 MB Module
  - 1.4 A with 4 MB and 6 MB Module

## Video Specifications

The video follows the PS/2 standard, with no sync on RGB, and no blanking pedestal. Black or blank: 0.0 V; White: 0.700 V.

There are five connections to a monitor that uses BNC (Bayonet Nut Connect) connectors: R, G, B, HSYNC (white or gray wire), and VSYNC (black wire).

## Mechanical Specifications

- Technology:
  - Hybrid of through-hole and surface mounting on a glass/epoxy board.
- Millennium card physical dimensions (excluding brackets):
  - $16.5 \times 9.5 \times 1.2$  cm

## Environmental Specifications

- Minimum/maximum ambient operating temperatures: 0 to 55° C
- Minimum/maximum storage temperature: -40 to 75° C
- Maximum altitude for operation: 3,000 meters
- Maximum altitude for transport: 12,000 meters
- Operating humidity: 20 to 80% relative humidity (non-condensing)
- Storage humidity: 5 to 95% relative humidity (non-condensing)

## Hardware settings

---

When you add a piece of hardware to a PCI system, the system BIOS will automatically map it to an available memory space for you. This is known as “Plug-and-Play, which means *you should not have to set switches or change jumpers on your Millennium card*. However, we have provided two DIP switches, which may be required in special circumstances. Take a moment to become familiar with your new Matrox Millennium card. The diagram on the next page shows you where some of the major components are located

To change a DIP switch setting, take the usual static electricity precautions, and use a small screwdriver or a ball-point pen. Avoid using a pencil tip, which can leave an electrically conductive graphite residue.

- ⊗ ***Turn off the power to all equipment. Touch the metal chassis of your computer to drain the static electricity from your body before you touch the Matrox card. Don't let your clothes touch any of the components while you work.***

### Switch 1: Flash EPROM Switch for VGA BIOS

If you need to upgrade your VGA BIOS in the future, this can be done by reprogramming the Flash EPROM. This safe and simple operation is accomplished with a software utility and a BIOS upgrade file. You set Switch 1 to ON to allow re-programming of the Flash EPROM. You must *not* leave this switch ON during normal usage, as the Flash EPROM in this state is susceptible to being erased without warning.

## Switch 2: VGA Enable/Disable switch

By default the VGA of your Millennium card is enabled (Switch 2=OFF) for single-screen operation, which means that you must remove or disable your existing VGA, if you have one. If the VGA is on the motherboard of your PCI system, it should be disabled automatically.

This switch should be set to ON if you want to work in a dual-screen configuration. In this case you will also be using either a VGA in another slot or on your system's motherboard, or another Matrox card for output to the second monitor.

### Matrox Millennium Card

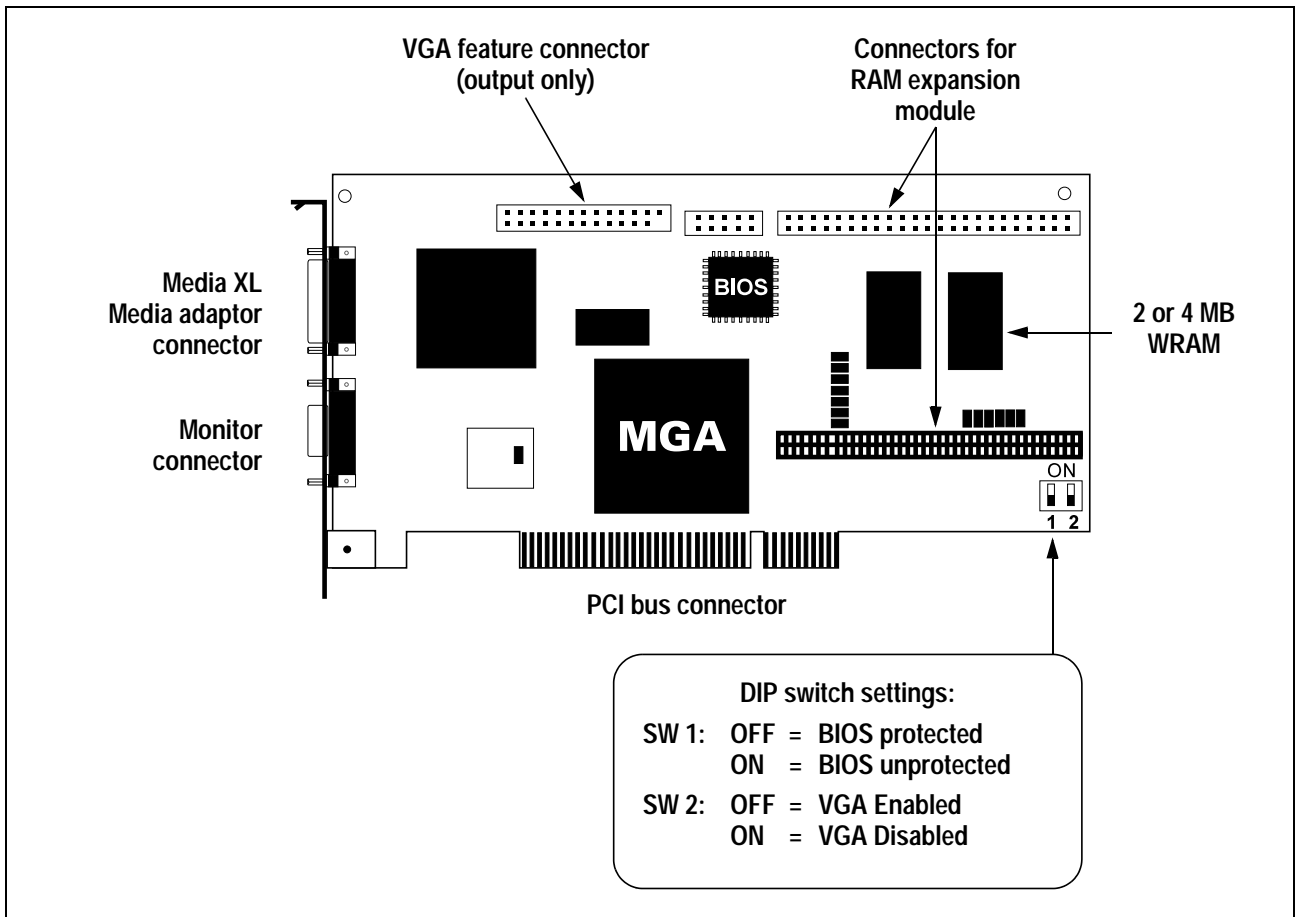

## Connector Pinouts

### Video Connector – Output to Monitor

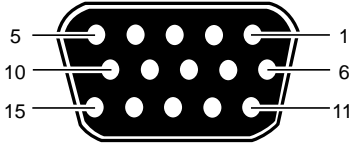
	1	Analog red output	10	Ground
	2	Analog green output	11	Not connected
	3	Analog blue output	12	SDA (DDC)
	4	Not connected	13	TTL horizontal sync
	5-8	Ground	14	TTL vertical sync
	9	Not connected	15	SCL (DDC)

### Media XL Input/Output Connector

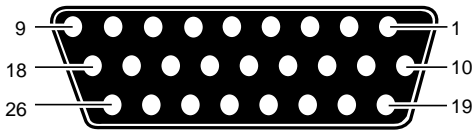
	1	Microphone (left)	14	Ground
	2	Ground	15	C in (chroma)
	3	Microphone (right)	16	Ground
	4	Ground	17	Y out (luminance)
	5	Line in (left)	18	Ground
	6	Ground	19	C out (chroma)
	7	Line in (right)	20	Ground
	8	Ground	21	Composite in (1)
	9	Line out (left)	22	Ground
	10	Ground	23	Composite in (2)
	11	Line out (right)	24	Ground
	12	Ground	25	Composite out
	13	Y in (luminance)	26	Ground

### VGA Feature Connector

	1-8	Pixel data	18	External sync enable*
	9	Pixel clock	19	External pixel clock enable*
	10	Blanking	20	Unused (reserved)
	11	Horizontal sync	21-24	Ground
	12	Vertical sync	25	Unused (reserved)
	13-16	Ground		
	17	External pixel data enable*		
	* When enabled, these signals are active low			

# Troubleshooting

This section contains solutions to problems you may encounter with your Matrox Millennium.

## Problem: Computer doesn't boot after Millennium card is installed

- **Cause** – Some computers may not properly detect the addition or change of an internal PCI card. On start-up, a computer may beep differently from normal to indicate this error.
  - ☑ **Solution** – Reset your computer's CMOS. This is usually done through a switch or jumper on the motherboard of your computer. Check your system manual or contact your computer vendor for instructions on how to do this.
- **Cause** – There may be another graphics adapter in your computer.
  - ☑ **Solution** – If another graphics card is plugged into an expansion slot, remove it.
  - ☑ **Solution** – If a graphics adapter is built-in to your computer's motherboard, your system may have not automatically disabled it when you inserted your Millennium card. Check your system manual for instructions on how to manually disable your computer's built-in graphics adapter.

## Problem: Wrong color balance, screen image off-center, or no picture at all

- **Cause** – Your monitor's video controls may be improperly set.
  - ☑ **Solution** – Adjust your monitor's controls (brightness, contrast and so on). See your monitor manual for more information.
- **Cause** – The monitor connections may have been inserted improperly.
  - ☑ **Solution** – Make sure the monitor's power cable is firmly in place.
  - ☑ **Solution** – Make sure the 15-pin connector (see picture) to the Millennium card is firmly in place.
  - ☑ **Solution** – If your monitor uses a 15-pin connector, make sure the connection to the monitor is firmly in place.
  - ☑ **Solution** – If your monitor uses BNC input (see picture below), make sure the Red, Green, Blue, Horizontal Sync (HSYNC – white or gray wire), and Vertical Sync (VSYNC – black wire) connections are firmly in place and plugged into the correct input.
- **Cause** – If your monitor uses BNC input (see picture), one or more connection settings may be incorrect.
  - ☑ **Solution** – Set each of your monitor's RGB input and sync switches (if available) to 75 ohms, with the sync set to "external". These controls are usually switches on the back of your monitor.

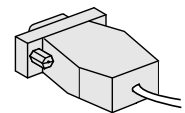

15-pin connector

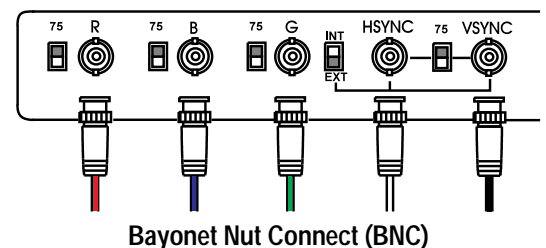

## **Problem: After the startup screen, monitor doesn't display properly (rolling screen images, overlapping screen images or a blank screen)**

- **Cause** – The MGA driver may be trying to use settings your monitor doesn't support. This could happen if a monitor was never selected in the software and you changed your display resolution to one your monitor doesn't support, or if you changed the monitor connected to your computer without changing it in the software.

**WARNING:** Selecting the wrong monitor in the software can damage *some* monitors. See your monitor manual for more information.

☑ **Solution – Windows 95:**

- 1 Press [Ctrl]+[Alt]+[Del] twice to restart your computer.
- 2 When you see “**Starting Windows 95...**”, press [F5] to enter “**safe mode**”.
- 3 Select your monitor in the **Display Properties** dialog box.  
(For more information, see the on-line documentation for MGA PowerDesk.)
- 4 Restart your computer.

☑ **Solution – Windows 3.1:**

- 1 Press [Alt]+[F4] (repeatedly, if other programs are running) to exit Windows 3.1.
- 2 Enter `del c:\mga\setup\mga.inf` to delete the MGA settings for your monitor.  
(The path may be different if you have a customized driver installation.)
- 3 Enter `cd c:\windows` to change your current directory, and then enter `setup`.  
(The path may be different if you have a customized Windows 3.1 installation.)
- 4 Select an MGA PowerDesk driver in the **Display** field and then exit the `setup` program.
- 5 Enter `win` to restart Windows 3.1 in 640 × 480 resolution.
- 6 Select your monitor with the **MGA Monitor Selection** program.  
(For more information, see the on-line documentation for MGA PowerDesk.)
- 7 Restart Windows 3.1.

☑ **Solution – Windows NT:**

- 1 Restart Windows NT in **VGA mode**.
- 2 Delete the `mga.inf` file in the `system32` subdirectory in your Windows NT directory.
- 3 **If you're using Windows NT 4.0:** Right-click on the Windows NT desktop background, click **Properties** menu item → **Settings** tab (Windows NT may warn you that you have invalid display settings; if so, click **OK** to acknowledge), and move the **Desktop area** slider down to 640 × 480 resolution and then click **OK**.  
**If you're using Windows NT 3.5:** Reselect your MGA driver through the **Control Panel** program → **Change Display Type** button → **Change** button.
- 4 Restart Windows NT.
- 5 Select your monitor through the **Control Panel** → **MGA Panel** applet → **Monitor** tab.
- 6 Reselect the display resolution you want.



- ☑ **Solution – OS/2:**
  - 1 Reinstall the MGA drivers. (See [page 16](#) for instructions.)
  - 2 Select your monitor through the **MGA Settings** program → **Monitor** tab.
  - 3 Select your display resolution through the **MGA Settings** program → **Resolution** tab.
  - 4 Restart your computer.

**Problem: Other device doesn't work properly after Millennium card is installed**  
**(examples: sound card output distorted, fast modem loses data often)**

---

- **Cause** – Some computers require that software wait for the hardware to be ready to receive new data. The Millennium drivers are *not* normally set do this because it slows them down slightly and it's not necessary for most computers.
  - ☑ **Solution – Windows 95:**
    - 1 Right-click on the Windows 95 desktop background.
    - 2 Click **Properties** menu item → **MGA Settings** tab → **Advanced** button → **Performance** tab.
    - 3 Clear the **Use automatic PCI bus retry** check box.
    - 4 Click on the **OK** → **OK** → **Yes** buttons to accept the changes and restart your computer.
  - ☑ **Solution – Windows 3.1:** Edit the *system.ini* file in your *windows* directory to add the line **PciChipSet=1** to the “[mga.driv]” section. You can use the **Notepad** program to edit this file.
  - ☑ **Solution – Windows NT:** See the *readme.nt* text file for information on how to change **User.SynchronizeEngine** setting.

**Problem: After game for Windows 95 starts, monitor doesn't display properly**  
**(rolling screen images, overlapping screen images or a blank screen)**

---

- **Cause** – If your game uses a low-resolution (640 × 480 and below), full-screen display mode, your monitor may not support the refresh rate the MGA driver is using.
  - ☑ **Solution** –
    - 1 If the game is still running in full-screen mode, press [Ctrl]+[Alt]+[Del] *once* for the **Close Program** dialog box, and then click on the **End Task** button.
    - 2 Right-click on the Windows 95 desktop background.
    - 3 Click on the **Properties** menu item → **MGA Monitor** tab → **MGA Monitor** option button.
    - 4 From the MGA monitor list, select the monitor model you're using. If your monitor model does not appear in the list, select a monitor that runs at 60 Hz at 640 × 480 (for example, **Standard Monitor Types** → **Vesa 1024X768 @60Hz**). For more information on MGA monitor selection, see the on-line documentation for MGA PowerDesk.
    - 5 Click **OK** to confirm your selection.

## **Problem: Game for Windows 95 doesn't start or runs slower than normal (program uses Microsoft DirectX interface)**

- **Cause** – DirectX may not be installed, or an older version of DirectX is installed. Most programs that use DirectX install it as part of their installation, but *some do not*. Also, some older programs may install an older version of DirectX (overwriting a newer version).
  - ☑ **Solution** – (See “DirectX installation required!” on page 10.)

## **Problem: Program for Windows 95 doesn't run properly or stops running**

- **Cause** – Some programs may not work properly with some MGA acceleration.
  - ☑ **Solution** – Disable specific types of software acceleration:
    - 1 Right-click on the Windows 95 desktop background.
    - 2 Click **Properties** menu item → **MGA Settings** tab → **Advanced** button → **Performance** tab.
    - 3 Clear one or more check boxes, starting with **Use Device Bitmaps Caching**. (For more information, see the on-line documentation for MGA PowerDesk.)
    - 4 Click on the **OK** → **OK** buttons to accept the changes.Depending on the feature you disabled, you may have to restart your computer for the changes to take effect.
  - ☑ **Solution** – Disable Matrox hardware acceleration altogether:
    - 1 Right-click on the **My Computer** icon on the Windows 95 desktop.
    - 2 Click on the **Properties** menu item → **Performance** tab → **Graphics** button.
    - 3 Move the **Hardware acceleration** slider to **None**.
    - 4 Click on the **OK** → **OK** buttons to restart your computer.

## **Problem: Screen image defects appear in Windows 95 (example: mouse cursor not drawn properly)**

- **Cause** – You may have a conflict because of previously installed display drivers.
  - ☑ **Solution** –
    - 1 Right-click on the **My Computer** icon on the Windows 95 desktop.
    - 2 Click on the **Properties** menu item → **Device Manager** tab.
    - 3 Click on the plus sign to the left of the **Display adapters** and **Other devices** items.
    - 4 Delete any display adapter *other than* **Matrox MGA Millennium PowerDesk**.
    - 5 Restart your computer.



### **Problem: MGA software for Windows 3.1 doesn't install properly**

---

- **Cause** – There may be an improperly made change to a Windows initialization file.
  - ☑ **Solution** – Check the *readme.win* file for the list of changes normally made to *system.ini*, *win.ini*, and *progman.ini*.

### **Problem: DOS / Super VGA (VESA) program doesn't work properly**

---

- **Cause** – Your program may not be compliant with the VBE 1.2 or 2.0 standard for VESA.
  - ☑ **Solution** – Contact your software vendor to see if there is an upgrade or fix for the program.

### **Problem: AutoCAD for DOS doesn't work properly**

---

- **Cause** – AutoCAD's environment variables may not be set correctly.
  - ☑ **Solution** – Check AutoCAD's environment variables, in particular: *acad* and *acaddrv*. (See the *MGA CAD Drivers Guide* for more information).



---

# Index

---

## 0-9

---

- 2 MB board ..... 21, 23
- 3D capabilities (table) ..... 21
- 4 MB board ..... 20, 21, 23
- 8 MB board ..... 21

## A

---

- acceleration, MGA ..... 30
- Adobe Acrobat PDFs ..... 2, 12, 19
- AutoCAD for DOS ..... 18

## B

---

- BIOS settings ..... 24
- BNC monitor connection ..... 27
- bus connector ..... 25

## C

---

- CD-ROM, Matrox ..... 1, 2, 5, 11, 14, 16
- CMOS ..... 27
- connector pinouts ..... 26

## D

---

- DDC monitor ..... 8, 11, 15, 17, 22
- DIP switch settings ..... 25
- DirectX ..... 10, 30
- display information ..... 21
- document conventions ..... 2
- documentation, on-line ..... 2, 10, 12, 19
- DPMS ..... 13
- driver modes (table) ..... 21
- DynaView 2D for Window 3.1 ..... 12
- DynaView 3D for Window 3.1 ..... 12
- DynaView for DOS ..... 18

## E

---

- EPROM ..... 18, 24
- expansion slots ..... 3, 4, 27

## H

---

- hardware
  - acceleration ..... 30
  - information ..... 5, 23
  - installation ..... 3
  - settings ..... 24

## I

---

- installing
  - AutoCAD for DOS software ..... 18
  - Matrox card ..... 3
  - MicroStation for DOS software ..... 19
  - OS/2 driver ..... 16
  - Windows 3.1 software ..... 11
  - Windows 95 software ..... 7
  - Windows NT 4.0 driver ..... 14

## M

---

- Matrox Millennium card ..... 25
- maximum display area (table) ..... 21
- maximum refresh rates (table) ..... 21
- media connector ..... 25
- Microsoft DirectX ..... 10, 30
- MicroStation for DOS ..... 18
- monitor connector ..... 26, 27
- monitor settings ..... 27
  - OS/2 ..... 17, 29
  - Windows 3.1 ..... 11, 28
  - Windows 95 ..... 8, 28, 29
  - Windows NT ..... 15, 28

## O

---

on-line documentation .....	2, 10, 12, 19
OS/2 .....	16
changing resolutions .....	16
display settings .....	17
monitor settings .....	17, 29

## P

---

PCI	
bus .....	3, 24, 27, 29
expansion slot .....	3, 4
PDF (Portable Document Format) .....	2, 12, 19
pixel depth (table) .....	21
Plug-and-Play	
card .....	24
monitor .....	8, 11, 15, 17, 22
PowerDesk, MGA	
Window 95 .....	5
Windows 3.1 .....	12
Windows NT .....	15
product specifications .....	23

## R

---

RAM expansion module .....	25
resolution (table) .....	21

## S

---

static electricity, warning .....	3
Super VGA .....	18, 19, 20

## T

---

technical information .....	23
troubleshooting .....	27

## V

---

VESA .....	1
DDC monitor .....	8, 11, 15, 17, 22
modes (table) .....	20
Super VGA .....	18, 19, 20
VGA .....	25
compatibility .....	23
connector .....	26
driver .....	3, 6, 11, 16
mode .....	23

## W

---

Windows 3.1 .....	11
DCI video driver .....	13
DMPS screen saver .....	13
DynaView 2D .....	12
DynaView 3D .....	12
monitor settings .....	11, 28
on-line documentation .....	12
uninstall program .....	13
upgrading to Windows 95 .....	6
Windows 95 .....	5
DirectX .....	10
display settings .....	9
monitor settings .....	8, 28, 29
on-line documentation .....	10
Windows NT .....	14
display settings .....	15
driver installation .....	14
monitor settings .....	15, 28
WRAM .....	25

---

# Matrox Millennium Release Note

---

February 4, 1997

10418-401-0303

This note contains important information about your Matrox graphics card. Due to the last-minute nature of this document, it is available in English only. We apologize for the inconvenience.

## Driver CD-ROM contents

---

The Matrox Millennium Driver CD-ROM contains:

- MGA PowerDesk for Windows 95 (version 3.2x) \*
- MGA PowerDesk for Windows 95 (version 3.1x) †
- MGA PowerDesk for Windows 3.1 \*
- Millennium Windows NT 3.51 & 4.0 drivers \* †
- MGA PowerDesk for Windows NT 4.0 (version 3.x) ‡
- Millennium OS/2 Warp driver ‡
- Millennium DOS AutoCAD DynaView driver \*
- Millennium MicroStation PC driver \*
- Millennium DOS utilities
- Adobe Acrobat Reader for Windows (version 2.1)
- MGA PowerDesk and Millennium Installation Guides \*
- CompCore SoftPEG MPEG Player 2.2
- Microsoft DirectX 2 and DirectVideo
- MGA CAD Users Guide \*
- Microsoft Video for Windows 1.1e
- Colorific for Windows 95
- Netscape Navigator 3.01 (16-bit and 32-bit versions)

\* Available in Intl 1: English, German, French, Italian and Spanish.

† Available in Intl 2: English, Dutch, Swedish, Norwegian, Portuguese (Brazilian), Danish and Finnish.

‡ Available in English only.

More languages will be available soon for some drivers.

## Installation overview

---

To install the Matrox Millennium:

- 1 Install the hardware. See “Quick hardware installation” in the *Installation Guide*.
- 2 Install the software. See the software section (Windows 95, 3.1, NT, OS/2 or CAD) of the *Installation Guide* that applies to you.

## Installation of MGA PowerDesk software for Windows 95

---

If you install the Millennium graphics card on a system with Windows 95 already installed, Windows 95 will detect the new graphics card after you restart your computer and may *automatically* load the Microsoft version of the MGA display drivers. ***Do not use the MGA driver provided by Windows 95.*** It does not support MGA PowerDesk. Use the driver supplied on the Matrox CD-ROM. Follow the instructions in the “Installing MGA PowerDesk software for Windows 95” section of the *Installation Guide*.



## DirectX for Windows 95 note

---

The Microsoft DirectX interface version 2.0 or later *must* be installed for DirectX programs (some games and multimedia software) to work correctly, and so these programs can benefit from Matrox hardware acceleration. The DirectX interface includes DirectDraw, DirectVideo, Direct3D and others. You may not need to install DirectX, since many programs install DirectX as part of their own setup. However, older programs may install an earlier version of DirectX.

### To see if DirectX version 2.0 or later is installed:

- 1 Right-click the Windows 95 desktop.
- 2 Click **Properties** menu item → **MGA Settings** tab → **Advanced** button → **Information** tab.
- 3 Look at the **Microsoft DirectX Version** label.

If DirectX 2.0 or later is installed, you may stop here. If not, follow the instructions below.

### To install DirectX version 2.0:

- 1 Insert the Matrox CD-ROM in your CD-ROM drive.  
(Windows 95 will automatically start the *mgasetup* program.)
- 2 Click **Microsoft DirectX 2 and DirectVideo** list item → **Install** button → **Next** button to begin installation.

<p><b>IMPORTANT:</b> If the setup program asks if you want to replace the existing display drivers, click <b>No</b>.</p>
--

- 3 Click **Reboot** to restart your computer and for the changes to take effect.

## Windows 95 troubleshooting

---

Here are some troubleshooting tips for Windows 95. This information is in addition to what's in the "Troubleshooting" section of the *Installation Guide*.

### Installation in languages Matrox doesn't provide translations for

If your Windows 95 is in a language we do not provide translations for (see footnote, page 1), you can still install our software. However, if you're installing MGA PowerDesk version 3.15 or later, you must manually install the drivers first and then run our setup program. To manually install version 3.2x drivers:

- 1 Insert the Matrox CD-ROM in your CD-ROM drive. Windows 95 will automatically start the *mgasetup* program; click **Exit** to close the *mgasetup* program.
- 2 Right-click the Windows 95 desktop background.
- 3 Click **Properties** menu item → **Settings** tab → **Change Display Type** button → **Change (Adapter Type)** button → **Have Disk** button.
- 4 Type *d:\mgapdx64.inf* in the input box, where "d" is the drive letter of your CD-ROM.
- 5 Click **OK** → **OK** → **Close** → **Close** → **Yes** buttons for the changes to take effect.

**NOTE:** If you install software in a language different from the language of your operating system (for example, English software on a Japanese system), you may have problems with text and dialog box controls being cut off. This is because of differences in system fonts.

### Driver conflicts

If you restart your computer with the Millennium card installed and Windows 95 warns you that your graphics card is not configured correctly, you may have a conflict with previously installed display drivers. Click **Cancel** if Windows 95 prompts you to start the **Add New Hardware Wizard**. If you start the Wizard, it will *not* detect your Millennium card. To resolve a driver conflict:

- 1 Right-click the **My Computer** icon on the Windows 95 desktop.
- 2 Click the **Properties** menu item → **Device Manager** tab.
- 3 Click the plus sign to the left of the **Display adapters** and **Other devices** items.
- 4 Delete *all* listed display adapters (by selecting each, then clicking the **Remove** button).
- 5 Restart your computer and follow the setup instructions in the "Windows 95 software" section in the *Installation Guide*.

### Scitec Display Doctor

Before running the Scitec **Display Doctor** program, clear the **Use Device Bitmaps Caching** check box in the **Display Properties** dialog box → **MGA Settings** tab → **Advanced** button → **Performance** tab.

---

# MGA PowerDesk for Windows NT 4.0

---

February 4, 1997

10418-401-0302

This note contains important information about your Matrox graphics card. Due to the last-minute nature of this document, it is available in English only. We apologize for the inconvenience.

---

## Latest version of MGA PowerDesk for Windows NT

---

The Matrox CD-ROM includes the latest version of MGA PowerDesk for Windows NT 4.0, with all the advanced features listed below. This version is in English only. More languages will be available soon.

### MGA PowerDesk (version 3.x) for Windows NT includes:

- **Fast display driver** for Matrox Mystique and Matrox Millennium with;
  - Multi-display support for up to four monitors at a time.
  - Accelerated DirectDraw and OpenGL support for direct access to Matrox hardware.
  - Plug-and-Play (DDC-2b) monitor support.
- **MGA Monitor** property sheet to change your monitor settings. The setup program adds this sheet to the Windows NT **Display Properties** dialog box. You can optimize your monitor settings through interactive testing and adjustment.
- **MGA Settings** property sheet to change your display settings. The MGA setup program adds this sheet to the Windows NT **Display Properties** dialog box. This sheet provides access to MGA PowerDesk features such as;
  - **Desktop mode** buttons to configure a desktop area of varied shapes (proportional, horizontal, vertical) that goes beyond the limits of the display.
  - **Display schemes** to easily switch between your pre-defined display settings.
  - **Information** property sheet to display hardware and software version numbers and capabilities.
  - **Performance** property sheet to configure advanced driver performance settings.
  - **MGA PowerDesk** property sheet with settings for;
    - PixelTOUCH to zoom in and pan on your view area.
    - CenterWINDOW to center opened windows in your view area.
    - MaxVIEW to maximize windows in your view area instead of your desktop.
    - CenterPOPUP to have new windows pop up in the center of your current view area.

- **MGA Desktop Navigator** (DeskNav) program to quickly change the view area of your desktop and give you quick access to the PixelTOUCH zoom and CenterWINDOW features. Access DeskNav through the **Start** menu → **Programs** → **MGA PowerDesk NT** folder.
- **MGA QuickDesk** program to quickly switch between your saved display schemes, open the **Display Properties** dialog box or launch **MGA Desktop Navigator**. This program appears as a monitor icon on the Windows NT taskbar.

## **To install version 3.x of MGA PowerDesk for Windows NT**

---

- 1** Insert the Matrox CD-ROM in your CD-ROM drive.  
(Windows NT will automatically start the *mgasetup* program.)
- 2** Click **MGA PowerDesk for Windows NT 4.0 (v.3.00 Eng)** menu item → **Install** button.
- 3** The setup program will ask if you want to install MGA PowerDesk and drivers, or if you want to install only the drivers. Make your choice and then click **Install** to begin the installation.
- 4** The setup program will ask you what parts of MGA PowerDesk you want to install. If there is any option you don't want, clear its check box. Click **OK** to continue.
- 5** The setup program will *automatically* change the display adapter type to MGA mode. This is done through the Windows NT **Display Properties** dialog box. You'll be prompted to restart your system at the end of the installation procedure. Click **Yes** for the changes to take effect.

(When you first restart your computer, you may see a message saying your display settings are invalid. If so, simply click **OK** to continue.)

You can now change your display settings in the Windows NT **Display Properties** dialog box using the new **MGA Monitor** and **MGA Settings** property sheets. To access MGA display property sheets, right-click the Windows NT desktop background, and then click the **Properties** menu item.

## **Online documentation**

---

- You can access MGA PowerDesk for Windows NT online documentation through the **Start** menu → **Programs** → **MGA PowerDesk NT** folder.
- A *readme* file is also in the **MGA PowerDesk NT** folder.
- For context-sensitive Help where available, press [F1] or click the “?” icon in the title bar and then click the item you want help on. Right-click a help topic for a pop-up menu that lets you print or copy it.