

HARRIER

Jump Jet



IBM 286 (16+ MHz), 386, 486 and compatibles

Requires: 1 MB RAM • DOS 5.0 • Hard Disk • VGA/MCGA Graphics

Recommended: Joystick • Mouse

Supports: Ad Lib™ • Roland® • SoundBlaster™ sound

IBM is a registered trademark of International Business Machines, Inc.

© 1992 MicroProse Software Inc.

MICRO PROSE™
SIMULATION • SOFTWARE

HARRIER

Jump Jet



You'll never get closer to the real thing. Your only other option would be to join the Air Force! MicroProse, with the assistance of the RAF, brings you *Harrier Jump Jet*.

Fly the RAF's Harrier GR 7, or the US Marine Corps' AV-8B each with their individual rewards and promotions. Tackle three flashpoint areas of conflict: Hong Kong 1996, the Falklands 1997 and Nord Kapp 1998.

Use the unique ability of the Harrier to 'ground loiter' just behind the front line. Perform short sharp sorties before returning to pre-set 'hides'.

Learn to carry out short/vertical take-offs and landings, hover or, if necessary, fly backwards to confuse enemy pilots! Execute unique combat manoeuvres and arm your Harrier from the vast array of well-documented weapons.

Experience MicroProse's innovative Gouraud Graphic System that allows you to fly through accurately-contoured valleys and around massive mountain ranges.

From single mission sorties to the full blown campaign game, prepare to jump into the most authentic cockpit ever seen in a non-military simulator.

Get ready for a new direction in flight simulation!
Harrier Jump Jet from MicroProse.



MICRO PROSE™
SIMULATION • SOFTWARE

MicroProse Ltd., Unit 1 Hampton Road Industrial Estate,
Tetbury, Gloucestershire GL8 8LD. U.K. Tel: 0666 504326

© 1992 MicroProse Ltd. Copyright is claimed on the text and graphics for the design of the packaging and the manual and the computer software contained herein. ALL RIGHTS RESERVED.
IBM PC screen shots shown. Actual shots may vary. Made in the UK.



HARRIER IBM 3.5

HARRIER

Jump Jet



MICRO PROSE™
SIMULATION • SOFTWARE

HARRIER

Jump Jet



MicroProse Limited
Unit 1 Hampton Road Industrial Estate, Tetbury, Glos. GL8 8LD UK
Tel: 0666 504326

Copyright © 1992 MicroProse Limited

Game characteristics described in the documentation may vary on some computers
This documentation and accompanying manual and floppy disks are copyrighted. The owner of this product is entitled to use this product for his or her personal use. Except for back-up copies of the disks for personal use, no one may transfer, copy, back-up, give or sell any part of the manual or the information on the disk, or transmit in any form or by any means, electronic, mechanical, photocopying, recording or otherwise without the prior permission of the publisher. Any person or persons reproducing any part of this program, in any media, for any reason, shall be guilty of copyright violation and shall be subject to civil liability at the discretion of the copyright holder

CREDITS

The Software

| | |
|------------------------------|--------------------------------------------------------------------------|
| Programming by | Tim Adrian Scotney Neil D. Coxhead |
| 3D World Design | Amanda Roberts |
| 3D Graphics | Martin Calvert Kevin Ayre |
| Graphics | Jacqueline Govier Angus Fieldhouse Trevor Slater Drew Northcott |
| Original Music | John Broomhall |
| Sound Programming | Andrew Parton |
| Game Design | Mike Brunton Kristian Ramsey-Jones Tim |
| World Database Design | Kristian Ramsey-Jones Graeme Davis |
| Quality Assurance | Pete Woods Andrew Lockett Nick Stokes Philip McDonnell |
| Software Evaluation | Scott Johnson |
| Project Managers | Leo Fouhy Steve Hurley |
| Publishers | Paul Hibbard Pete Moreland |

Special thanks to the Pilots of 233 OCU RAF Wittering- Home of the Harrier.

CREDITS

The Manual

| | |
|---------------------------------------|--------------------------------------------------------------------------------|
| Manual Written by | Alkis Alkiviades Kristian Ramsey-Jones Jonathan Falconer Mike Brunton |
| Design & Typesetting | Joanna Smith Sarah Kerr Sarah Warburton |
| Packaging Design | Joanna Smith |
| Illustrations | Blue Chip |
| Graphics | Brushworks |
| Photographs | Aerospace Publishing Ltd British Aerospace |
| Harrier Technical Illustration | Quadrant Picture Library/ Flight International |

With grateful thanks to British Aerospace Public Relations Dept.

CONTENTS

| | |
|----------------------------------|----------|
| SIMULATION OVERVIEW | 8 |
| Introduction..... | 8 |
| Game Overview..... | 8 |
| This Manual..... | 9 |
| Sorting the Materials..... | 9 |

SECTION I

| | |
|-----------------------------------------------------|-----------|
| INSTANT FLIGHT | 12 |
| Vertical Landing Summary (simple flight model)..... | 16 |
| Short Take-off Summary | 16 |
| THE FIRST MISSION | 18 |
| The Controller | 19 |
| The Selector..... | 19 |
| Flying the Harrier | 27 |
| Short Take-off..... | 28 |

SECTION 2

| | |
|----------------------------------------|-----------|
| THE READY ROOM..... | 38 |
| Pilot Roster: Keyboard | 39 |
| Select Pilot..... | 39 |
| On Campaign/On Operations | 40 |
| Available | 40 |
| Game Type: Large Screen | 40 |
| Enemy Ground Troops..... | 41 |
| Enemy Pilots..... | 41 |
| Flight Model | 42 |
| Simplified..... | 43 |
| Easy..... | 43 |
| Realistic (the Flight Simulator) | 43 |
| Landings..... | 44 |
| No Crashes | 44 |
| Easy..... | 44 |
| Realistic | 44 |
| Weapons | 45 |
| Easy..... | 45 |
| Moderate..... | 45 |

| | |
|---------------------------|----|
| Realistic | 45 |
| Game Type..... | 45 |
| Training..... | 45 |
| Single..... | 45 |
| Day | 46 |
| Campaign | 46 |
| World: World Map..... | 46 |
| Hong Kong | 46 |
| Falklands..... | 46 |
| Nordkapp..... | 46 |
| Fly: Combat Monitor | 47 |
| Quit: Exit Sign | 47 |
| Briefing: Papers | 47 |

THE BRIEFING SCREEN

| | |
|-------------------------------------------|-----------|
| THE BRIEFING SCREEN | 48 |
| Continuing A Campaign..... | 49 |
| Campaign Status: Clipboard..... | 49 |
| New Campaigns..... | 50 |
| Briefing Session | 50 |
| Review Orders | 50 |
| Map on Screen: View the Campaign Map..... | 52 |
| Arming | 52 |
| Decline Mission..... | 52 |
| Fly | 52 |

ARMING THE HARRIER.....

| | |
|--------------------------------|-----------|
| ARMING THE HARRIER..... | 54 |
| The Arming Screen..... | 55 |
| Arrow Buttons Left/Right | 56 |
| Unload | 56 |
| Load..... | 56 |
| Info | 57 |
| Default Load..... | 57 |
| Jump to Armament Type | 57 |
| Internal Fuel Load | 57 |

FLIGHT CONTROLS

| | |
|-------------------------------|-----------|
| FLIGHT CONTROLS | 58 |
| The Flight Controllers | 59 |
| Short Take-Off (STO)..... | 60 |
| The Three Flight Models | 61 |
| Simplified Model | 61 |

HARRIER JUMP JET

| | | | |
|---------------------------------------------|-----------|-------------------------------------------|------------|
| Easy Model..... | 61 | Weapons Control Summary | 87 |
| Realistic (the Flight Simulator)..... | 62 | Harrier Weapons Summary | 88 |
| Vectoring in Forward Flight (VIFFing) | 62 | Key to Harrier Weapons Summary..... | 89 |
| Vertical Take-Off..... | 63 | Harrier Weapon Effectiveness Against | |
| Hovering..... | 64 | Common Targets..... | 90 |
| Flying Backwards | 65 | Key to Weapons Effectiveness Against | |
| Vertical Landing | 65 | Common Targets..... | 91 |
| Simple Flight Model | 65 | | |
| Easy/Realistic Flight Model | 66 | | |
| HEAD-UP DISPLAYS..... | 68 | THE COCKPIT DISPLAYS..... | 92 |
| General HUD Indicators | 69 | Autopilot..... | 94 |
| Heading Scale | 70 | Landing Gear | 94 |
| Airspeed..... | 70 | HUD Mode..... | 94 |
| Angle of Attack..... | 70 | Brakes Air/Wheel | 94 |
| Altitude Indicator | 70 | Airspeed..... | 94 |
| Vertical Velocity Indicator | 70 | Altitude..... | 94 |
| Flight Path Indicator..... | 70 | Fuel | 94 |
| Pitch Lines..... | 70 | Thrust % RPM..... | 95 |
| Specific Function HUDs..... | 71 | JPT | 95 |
| V/STOL HUD | 71 | Nozzle Angle..... | 95 |
| Side Slip Indicator..... | 71 | Nozzle Keys | 95 |
| R value..... | 72 | Damage Systems Indicator..... | 95 |
| J value..... | 72 | Auto Defence..... | 95 |
| N value | 72 | Chaff..... | 95 |
| Flight Path Indicator..... | 72 | Flares..... | 96 |
| NAV HUD | 73 | ECM | 96 |
| Inertial Navigation System (INS) | | Cockpit Warning Lights..... | 96 |
| Direction Indicator | 73 | The Multi-Function Displays..... | 96 |
| M value | 73 | Ordnance/Equipment Display | 96 |
| g value..... | 73 | Mission Briefing Reminder | 97 |
| Air/Ground Attack HUD Modes..... | 74 | Tactical Compass | 97 |
| Cannons | 74 | Moving Map Display..... | 97 |
| Rockets..... | 76 | Tracking Camera View | 97 |
| Air-to-Air Guided Missile..... | 77 | | |
| Air-to-Ground Laser-Guided Missiles..... | 78 | | |
| Air-to-Ground Radar-Guided Missiles..... | 79 | | |
| Laser-Guided Bombs..... | 80 | | |
| Retarded, Cluster, Anti-Runway and | | | |
| Free-fall Bombs..... | 82 | | |
| Firing Weapons in Salvoes | 84 | | |
| Reconnaissance Camera..... | 85 | | |
| Stores Empty HUD..... | 86 | | |
| Night Vision Goggles/FLIR | 86 | | |
| | | CAMERA AND VIEW CONTROLS.... | 98 |
| | | Cockpit Views..... | 99 |
| | | Function Key | 100 |
| | | Tactical Views..... | 100 |
| | | Free-Flying Camera Views | 100 |
| | | MISSING DEBRIEFING | 102 |
| | | Day End Intelligence/Report Screens | 104 |
| | | Day Operations End..... | 104 |
| | | Medals and Promotions..... | 104 |
| | | Campaign End | 104 |

HARRIER WEAPONS AND

SUPPLIES..... 106

| | |
|-------------------------------------|-----|
| Cannons | 107 |
| Air-to-Air Guided Missiles..... | 108 |
| Air-to-Ground Guided Missiles | 109 |
| Rockets..... | 112 |
| Laser-Guided Bombs..... | 112 |
| Retarded Bombs..... | 114 |
| Free-Fall Bombs..... | 115 |
| Cluster Bombs..... | 117 |
| Anti-Runway Weapons..... | 119 |
| Fuel-Air Munitions | 120 |
| Other Supplies..... | 121 |

MISSION TYPES..... 122

| | |
|------------------------------------------|-----|
| Air-to-Ground Missions | 123 |
| Deep Strike Missions | 124 |
| Ground Support Missions..... | 124 |
| Iron Hand AA A and SAM Suppression | 125 |
| Interdiction..... | 125 |
| Air-to-Air Missions | 126 |
| Air Intercept Missions | 126 |
| Combat Air Patrol (CAP)..... | 126 |
| BARCAP | 127 |
| Reconnaissance Missions..... | 127 |

THE CAMPAIGNS 127

| | |
|---------------------------|-----|
| Hong Kong | 129 |
| The Falkland Islands..... | 133 |
| Nordkapp..... | 137 |

HARRIER KEY GUIDE..... 140

| | |
|----------------------------------------|-----|
| Engine Power and Nozzle Controls | 141 |
| The Keyboard Flight Controller..... | 141 |
| General Flight Controls..... | 142 |
| Displays | 143 |
| Weapon Controls..... | 143 |
| Defence Controls | 144 |
| Camera and View Controls..... | 144 |
| Cockpit Views | 144 |
| Tactical Views..... | 144 |
| Free-Flying Camera Views..... | 145 |
| Game Controls | 145 |

| | |
|--------------------------|-----|
| Game Menus | 145 |
| Quit Menu | 146 |
| Configuration Menu | 146 |
| Gameplay Menu..... | 146 |

SECTION 3

HARRIER AIR AND GROUND

ATTACKS 150

| | |
|---------------------------------------------------|-----|
| Air-to-Ground Missiles..... | 151 |
| 'Fire-and-Forget'..... | 151 |
| Laser Guided Bombs..... | 151 |
| Retarded Bombs | 152 |
| Free-Fall Bombs | 153 |
| Reconnaissance | 154 |
| Air-to-Air Combat | 154 |
| Surprise!..... | 154 |
| Exchanging Missiles..... | 155 |
| Dogfights | 156 |
| Get On His Tail! | 156 |
| Go Faster! Climb Higher! | 156 |
| Escape Manoeuvres..... | 156 |
| "VIFFing" (Vectoring in Forward Flight)..... | 158 |
| Enemy Surface-to-Air Missile Systems (SAMs) | 159 |
| Medium/Long Range SAMs | 159 |
| Evading Radar-Guided SAMs..... | 161 |
| Infra Red Homing SAMs..... | 161 |
| Evading SAMs..... | 162 |

SECTION 4

THE HARRIERS 169

| | |
|----------------------------------|-----|
| The GR Mk.7..... | 169 |
| Specification | 169 |
| The Pegasus Engine | 170 |
| Inside the Cockpit | 171 |
| Avionics..... | 172 |
| Electronic Countermeasures | 173 |
| Night Operations..... | 173 |
| Weapons and Stores..... | 174 |
| Reaction Control System..... | 175 |
| Landing Performance | 176 |
| Structure..... | 176 |

HARRIER JUMP JET

| | |
|-------------------------------------------|-----|
| The Wing and LERX | 176 |
| Electrical Systems | 176 |
| GTS/APU | 177 |
| Fibre Optic Technology | 177 |
| Systems | 177 |
| Fuel System | 178 |
| Pressurisation and Air Conditioning | 178 |
| Oxygen System | 179 |
| Anti-g System..... | 179 |
| Hydraulic System | 179 |
| Escape System | 179 |
| The AV-8B | 180 |
| AV-8B Harrier II Specification | 181 |
| The Sea Harrier FRSI | 182 |
| Sea Harrier FRSI Specification | 183 |
| Power Plant..... | 184 |
| Cockpit..... | 184 |
| Avionics..... | 184 |
| Electronic Countermeasures | 185 |
| Weapons and Stores..... | 185 |

OPERATING FROM DISPERSED

SITES 186

| | |
|------------------------------------------|-----|
| The Conventional Airfield | 187 |
| The Concept of Dispersed Operation | 188 |

THE DEVELOPMENT OF THE

HARRIER..... 192

| | |
|--------------------------------------|-----|
| Early Military V/STOL Aircraft | 193 |
| British Developments | 194 |
| The Flat-Risers | 195 |
| The Jet-Engines..... | 195 |
| Lift Engines | 196 |
| The P.1127 | 198 |
| Flying Prototypes | 200 |
| The Kestrel | 201 |
| The Harrier in Production..... | 202 |
| The GR Mk.5 | 204 |
| The GR Mk.7 | 204 |
| The Night Attack Harrier II | 205 |

THE US MARINE CORPS

HARRIERS.....206

| | |
|------------------------------|-----|
| The AV-8A | 207 |
| The Development of Harrier | |
| Combat Tactics | 208 |
| The AV-8B Harrier II | 208 |
| The Squadrons | 209 |
| USMC Harrier Operation | 210 |
| Combat Operations..... | 210 |

THE FALKLANDS WAR212

| | |
|------------------------------------|-----|
| Royal Navy Sea Harrier FRSIs | 214 |
| Royal Air Force Harrier GR3s | 214 |
| Combat Tactics | 215 |
| Combat Air Patrols (CAP) | 216 |
| Ground-Attack Missions | 216 |

HARRIER PILOT TRAINING218

| | |
|----------------------------------------------|-----|
| Conversion Training: Basic Squadron | 219 |
| Conversion Training: Advanced Squadron | 220 |
| Conversion Training: Operational Phase | 221 |
| 'Pairs Leader' | 221 |

THE HONG KONG CAMPAIGN222

| | |
|--------------------------|-----|
| Intelligence Files | 223 |
| Chinese Aircraft..... | 223 |

THE FALKLANDS CAMPAIGN230

| | |
|--------------------------------|-----|
| Intelligence Report | 231 |
| Argentine Aircraft | 231 |
| Argentine Tanks and APCs | 236 |

THE NORDKAPP CAMPAIGN238

| | |
|--------------------------|-----|
| Intelligence Files | 239 |
| Russian Aircraft..... | 239 |
| Russian Tanks, APCs..... | 246 |
| Russian AA & SAMs | 251 |

INTELLIGENCE FILE254

| | |
|--------------------------|-----|
| UK and US Aircraft | 255 |
| Allied Ships | 264 |

GLOSSARY266

HARRIER JUMP JET

SIMULATION OVERVIEW

Introduction

Harrier Jump Jet is an incomparable flight simulation. It allows you to experience the Harrier's unique combat capability: 'ground loitering' behind the front line ready to perform a series of short, sharp sorties and then returning to pre-set 'hides'. Execute short or vertical take-offs and landings, hover or, if necessary, fly backwards to confuse enemy pilots! Get to grips with special combat manoeuvres, arm your Harrier from the vast array of well-documented weapons and delve into the complexities of one of the most detailed Head-Up Display modes ever seen in a flight simulation.

Harrier Jump Jet uses MicroProse's innovative Gouraud Graphic System to produce 3-D game worlds where you are able to fly *through* accurately-contoured valleys and *around* massive mountain ranges. From single mission training sorties to the full-blown campaign games, prepare to jump into the most authentic cockpit ever seen in a flight simulator. *Harrier Jump Jet* is produced with the assistance of real Harrier pilots and it's the nearest you'll get to piloting the real Harrier short of joining the Air Force!

Game Overview

Harrier Jump Jet is a simulation of the US Marine Corps AV-8B, and the RAF's Harrier GR.7. Your first decision will be which Air Force to join and then which of the three flash point areas of conflict you want to fly in. You are advised, even if you are a flight sim veteran, to complete several training missions in order to get to know the Harrier's unique capabilities in short take-off and vertical landing. Even for computer pilots it may take some time to come to terms with an aircraft that comes to a complete stop in the air!

Once you feel confident of all flying controls of *Harrier Jump Jet*, try to get to grips with the weapons and stores that can be carried and their particular function, the different mission types and the accurate HUD modes available in the simulation. You may feel overawed by the sheer detail of this part of the game but remember, you are probably experiencing the same bewilderment that a rookie Harrier pilot feels when he starts his training.

This Manual

The manual is organized to help you learn the simulation quickly and get into the air without delay.

In Section One, there is an Instant Flight summary and a First Mission Guide to take you through a complete training sortie.

Section Two includes all the simulation details: cockpit and flight controls, HUDs, mission types, Views, Keys, Weapons available, Campaign details and Maps. This section can be used as reference when you want to consult more detailed aspects of *Harrier Jump Jet* control systems.

Section Three can be consulted if you want to improve air combat, ground attack or missile evasion techniques. Experienced MicroProse pilots will be familiar with most of the information but are advised to pay particular attention to the unique Harrier dogfighting manoeuvres made possible by VIFFing.

The final part of the manual, Section Four provides background detail including a complete guide to the Harrier, a history of its development and a reference section of some of the numerous weapons, aircraft, tanks, guns and missiles found in the simulation.

In addition, throughout the manual, a combat pilot will appear with important tips and advice. If you do not want to be bothered with reading the complete manual and wish to 'flick through', it's recommended you pay particular attention to any page on which the combat pilot appears.

Sorting the Materials

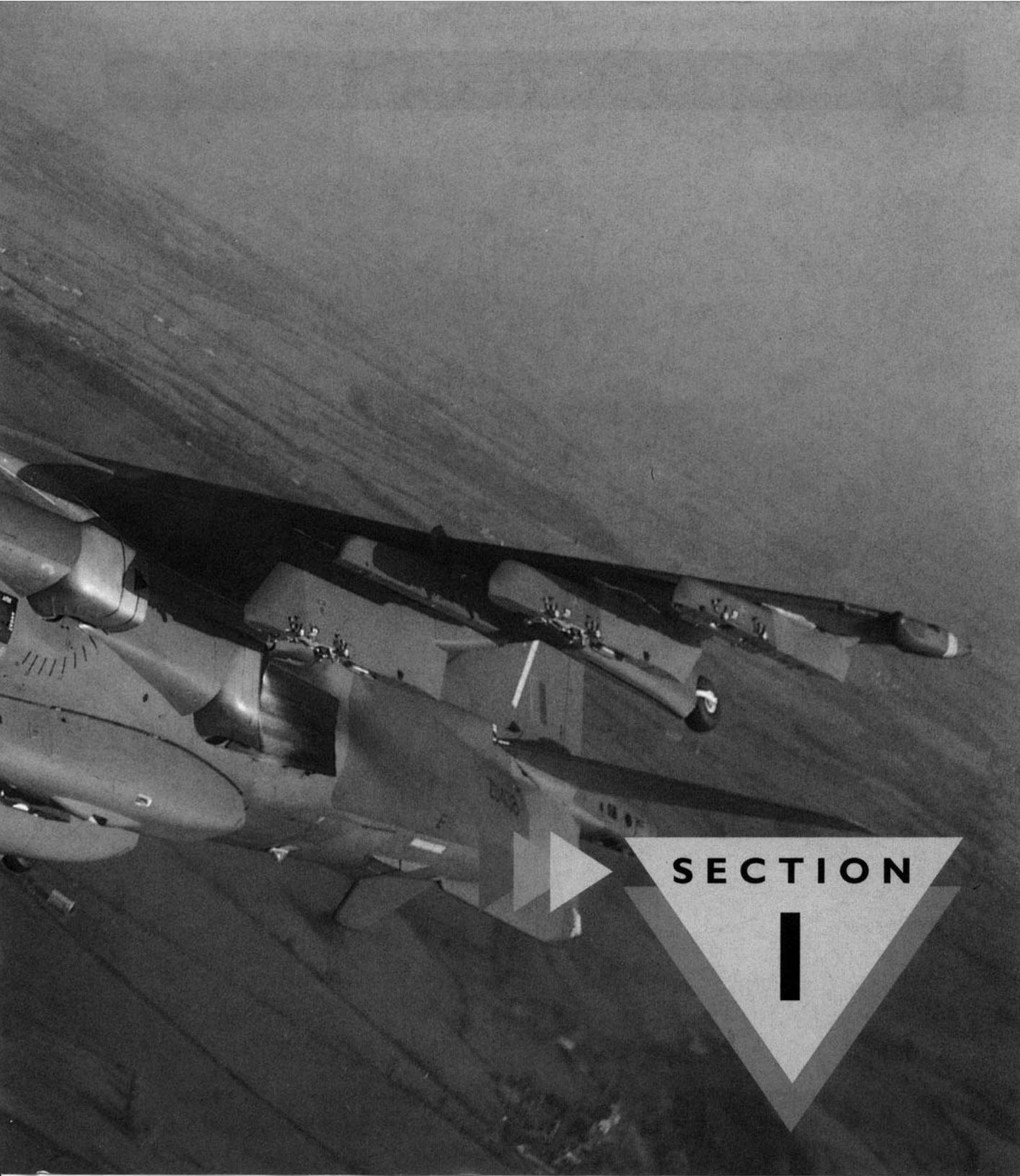
Contents

Your *Harrier Jump Jet* package contains this Manual, a Technical Supplement (including a pull-out Key Guide), three game world Maps and a set of disks to run the simulation.

Installation and Loading

The Technical Supplement gives specific instructions for loading and/or installing the simulation for your specific computer.





SECTION

I



**INSTANT
FLIGHT**

HARRIER JUMP JET

INSTANT FLIGHT



An RAF GR.7 takes off from a tree-lined road

This section is intended for those who want to jump into the Harrier and fly around the combat worlds as quickly as possible. This is often the best way to 'learn' a flight simulation.

We suggest you try the Instant Flight method, then attempt the First Mission Guide before undertaking any campaign-based sorties.

1. Install and Load the Simulation

Refer to the *Harrier Jump Jet* Technical Supplement for your particular make of computer.

2. Copy Protection

After the initial screen graphics, you will be asked a manual-related question. Type in the correct answer from the indicated page reference.

3. Log onto the Pilot Roster.

Type in your name and select your choice of Air Force. Press Return.

5. The Key Guide

We recommend you have the Key Guide open close to your keyboard to help you find all the necessary keys. Remember that the **Escape Key** will **Pause** the simulation and give you plenty of time to look at the manual.

6. Consult the Manual.

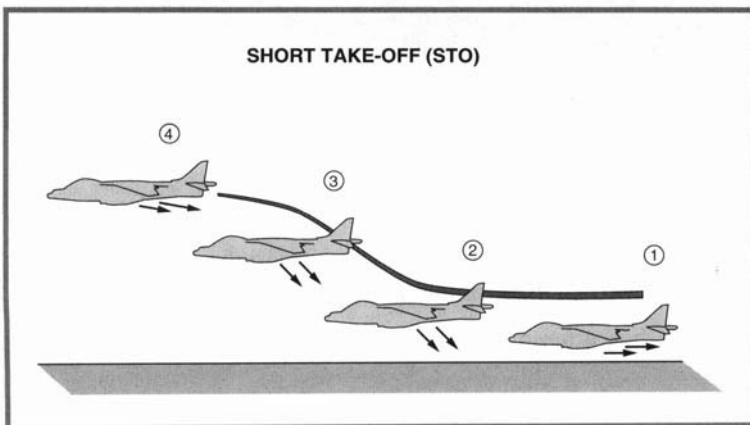
Skim through the **Cockpit** and **Flight Controls, Views** and **Head-Up Display** chapters in Section Two of this manual.

7. The Ready Room Screen

Move your *controller* arrow cursor across the screen and you will see various 'hot-spot' legends.

8. Instant Flying Action

To jump into the Harrier cockpit, simply move your *controller* arrow cursor over the 'Fly' legend in the top left-hand screen and select.



9. Short Take-Off

Press **Shift/ Plus +**

After 3 seconds (at 90 kts) tap the **Open Square Brackets Key [** once.

You will rise up in the air

Raise Gear (Key G). Flaps will auto adjust.

Set nozzles to 0° by pressing **Shift Close Square Brackets Key]**

Press **Minus Key -** to reduce engine thrust to approximately 85% (the R value on the lower left of the HUD)

Remember to use the pause key (Escape) in order to freeze the action and consult sections of the manual.

Pay particular attention to the two Multi-Function Displays (MFD). These show a great deal of valuable information. You can cycle through the different modes by pressing Key Z (left-hand MFD), Key X (right-hand MFD).

10. Turn on the Autopilot (Key A).

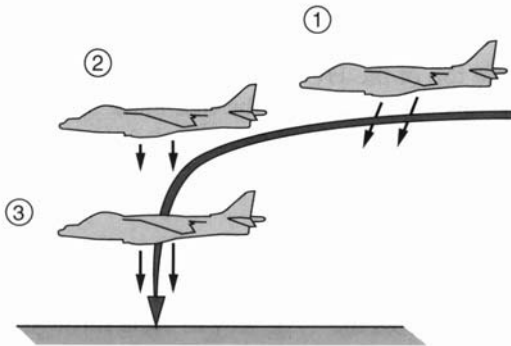
You will be put on the correct course to a waypoint.

Look at the INS marker below the central tick mark at the top of the HUD. This shows the bearing to a waypoint. If you decide to fly the Harrier yourself, keep this bar centred on the tick mark and you will head for a target/waypoint.

If you get lost, select Autopilot again.

11. Using the Manual and the Pause Key:

- Examine all external Views.
- Look at the three main HUD (Head Up Display) modes. Press the TAB Key to cycle through them and leave on A/G HUD mode.
- Experiment with weapons selection. Cycle through the right-hand Multi-Function Display (Key X) until you see the weapons select diagram. Press Return to select a weapon. Look at the different HUDs for each weapon selected.
- Look at the weapons section in the manual and become familiar with their names and functions.
- If you are attacked, try some basic Air Combat manoeuvres including VIFFing. Try out Auto Defence (Key D).
- Fly around your area of conflict. Attack any targets you encounter.
- Try a vertical landing.

VERTICAL LANDING (VL)

Vertical Landing Summary

(simple flight model)

Press keyboard Key 0 to implement Auto Hover. This will also drop gear and flaps.

When you come to a stop (no forward speed), press Key Minus - to reduce power.

Short Take-off Summary

Press **Shift/ Plus +**

At 90 kts tap Open Square Brackets **Key [** once.

You will rise up in the air

Raise Landing Gear (Key G)

Set nozzles to 0° by pressing Shift/Close Square Brackets **]**.

Press **Minus Key -** to reduce engine thrust to approximately 85%.

Don't be afraid to make mistakes.

Instant Flight will give you a flavour of the simulation but you need not complete a mission. The First Mission Guide (see the next section) will take you through a complete sortie in Training mode.

HARRIER JUMP JET



**THE
FIRST
MISSION**

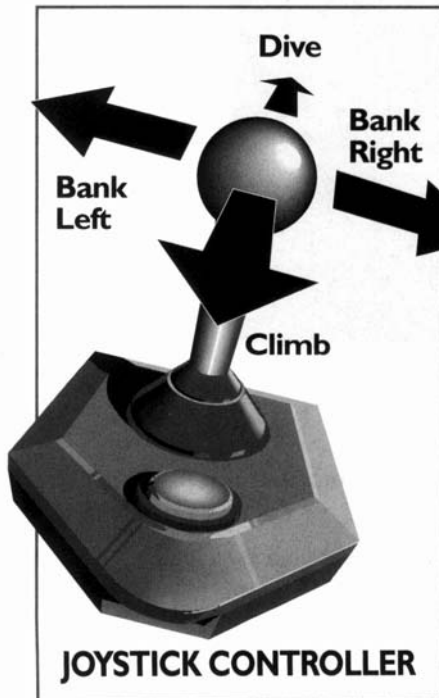
HARRIER JUMP JET

THE FIRST MISSION

This detailed guide will help you through your first *Harrier Jump Jet* mission. This is a Training Mission and you will fly the Simple Harrier Flight Model.

If you are new to flight simulations, you are advised to complete this mission carefully to give you a 'feel' for the Harrier controls. Take time to consult the maps and diagrams in the manual and pay particular attention to the detailed Head-Up Display modes.

If you are an experienced flight sim player and want to jump into the aircraft as soon as possible, turn to the Instant Flight section.



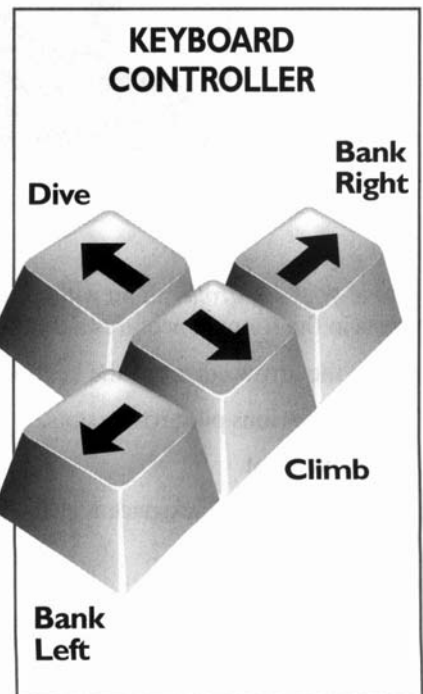
The Controller

Harrier Jump Jet can be controlled using a combination of keyboard, mouse or a joystick. For flying it is recommended you use a joystick and for menu selection it is recommended you use the mouse pointer. Flight control is not possible with a mouse. In this manual, which is applicable to all computer systems, the three control devices will be referred to as the *Controller*.

The Selector

At various times during the game you will be asked to select from a series of options, fire cannons

or missiles. Once again you may use any one of three devices: keys on the keyboard, left-hand mouse button or joystick fire button. In this manual these will be referred to as the *Selector*.



After the opening sequences, the simulation will put you into the Ready Room. This is the central base for all training flights and missions.



The Ready Room

Move your *Controller*. You will notice an arrow cursor moving around the room and, as it passes specific areas in the room, it acquires a different pop-up legend below it.

Move the arrow cursor to the keyboard and the Roster legend will appear. Press your *selector*.

You will see various pilot roster slots.

Highlight a slot.

Press the Delete/Backspace Key to clear the slot if a name is already there and type in your own choice of name.

Press Return.

You will then be prompted for your choice of Air Force.

HARRIER JUMP JET

Select US Marine Corps. (USMAC - AV-88)

Press your *selector* and you will return to the Ready Room.

Move the arrow cursor over the largest monitor. The legend Gametype will appear below it.

Select Gametype.



The Gametype Screen

This screen allows you to set all difficulty levels, training/campaign modes and simple/easy and realistic flight modes.

The choices are already set up but take time to check that they are correct. To alter settings click on the green tabs (cycle through).

For this First Mission guide you should have the following set up:

| | | | |
|---------------|------------|------------|----------|
| Enemy Troops: | Green | Landings: | No Crash |
| Enemy Pilots: | Green | Weapons: | Easy |
| Flight Model: | Simplified | Game Type: | Training |

When you have made (or checked) your choices, select **Done** and you will return to the Ready Room.

Next, move the arrow cursor and select the World Map (bottom left).

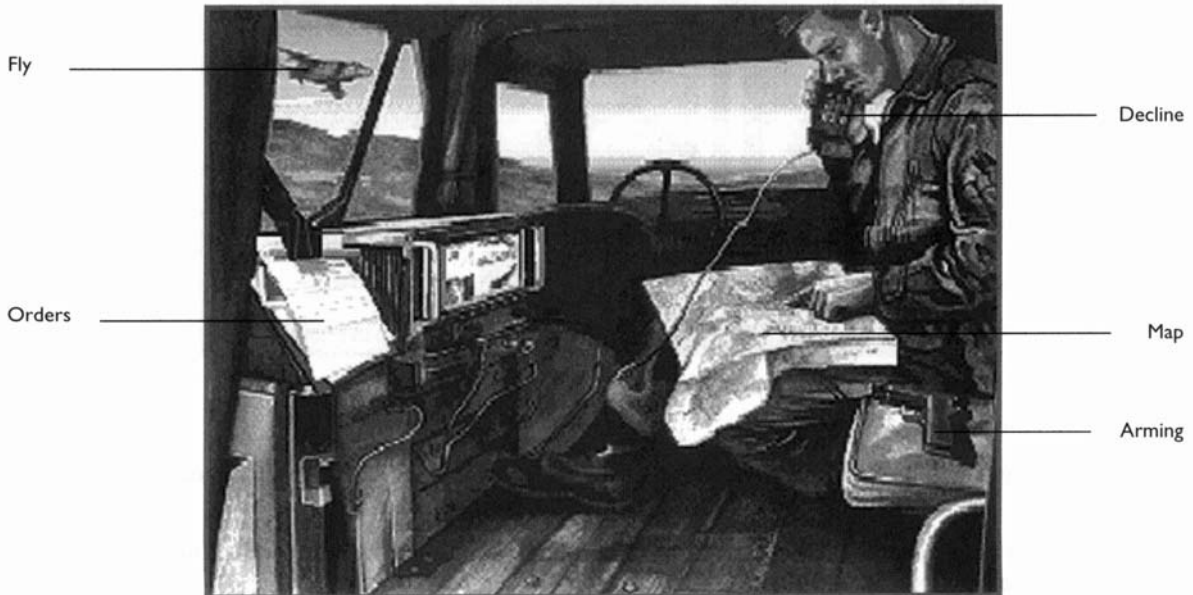
You will see a close up of the map with the three areas of conflict highlighted.

The Hong Kong Campaign should already be selected. Move your arrow cursor over the highlighted box. You will be given a brief summary of the conflict.

Select Exit to leave the World Map and you will return to the Ready Room.

You can, at this stage, choose Instant Flight by moving the arrow cursor over the top-left monitor in the Ready Room (see previous section). But, in this First Mission guide, it is recommended you study the Mission Briefing and Arming Screens.

Select Briefing and you will enter Mission Briefing.



The Mission Briefing Screen

In the same manner that you investigated the Ready Room, you can move your arrow cursor around to highlight various accessible areas in the Mission Briefing Screen.



HARRIER JUMP JET

If you click on the documents on the left-hand side of the screen, you will see details of the Training Mission Orders indicating:

Type Of Mission

Mission Callsign

Take-Off Time

Take-Off Base Name and Grid Reference

Landing Base Name and Grid Reference

Primary Target and Grid Reference (if applicable)

Secondary Target and Grid Reference (if applicable)

The Distance Roll-in Points are set from targets (When you will have to switch to Air/Ground attack HUD mode).

Clicking on the Next button with your *selector* will allow you to view the next sheet. This shows:

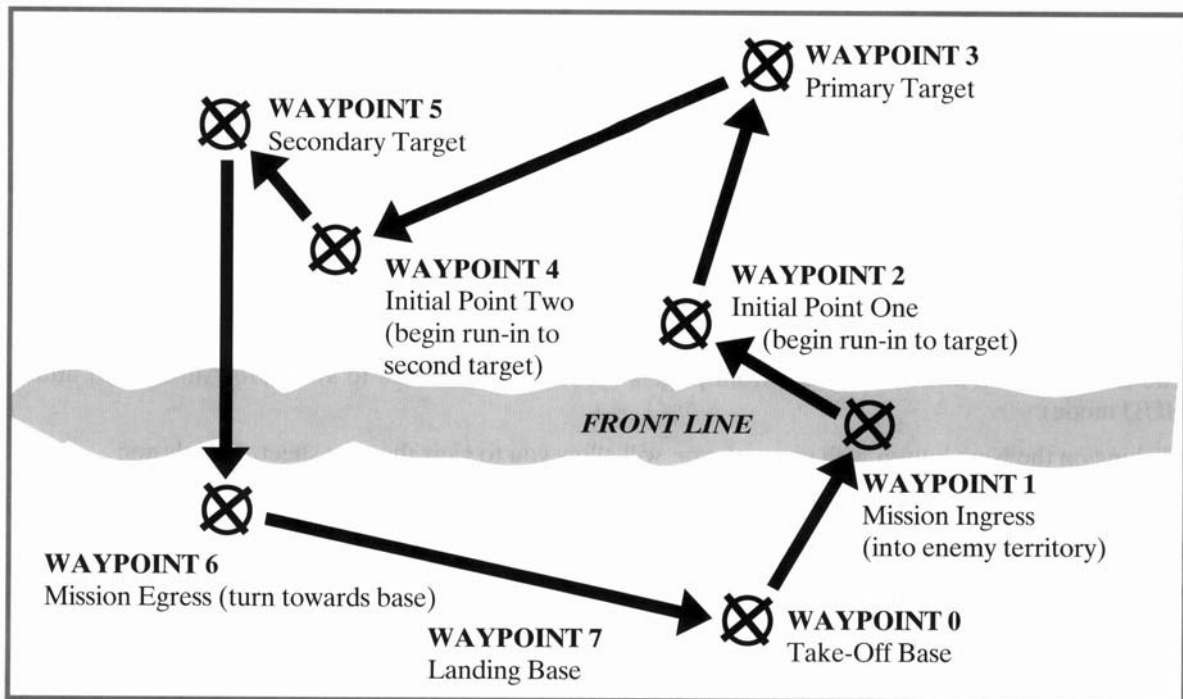
The pre-set weapons carried for that particular mission.

Day/Twilight/Night mission summary.

Wind Strength and Direction

Expected Enemy Activity.

A Harrier ground attack mission has eight waypoints shown on your HUD information:



The Primary Target in this first mission will be an Ammunition Dump.

The ideal weapon against this is a Paveway laser-guided bomb (GBU-16).

The Secondary Target in this first mission will be a static Truck Formation.

The ideal weapon against this target is the Rockeye II Cluster Bomb.

You will be given the above weapons in a default load which will also include 25mm Cannon (GAU-12U) and two Sidewinders (AIM-9S) for air combat.

Select Exit to re-enter the Mission Briefing Screen.

Now select the Map to access a close-up view of a large scale map of the combat area. Click on the next waypoint icon to see the flight paths and waypoints.

Red crosses are enemy ground installations

Green crosses are friendly objects

Yellow crosses are assigned targets

Blue crosses are friendly bases

The information is repeated in your cockpit Multi-Function Display (MFD). You will also be able to track your flight path by using the combat maps in your *Harrier Jump Jet* package.

HARRIER JUMP JET

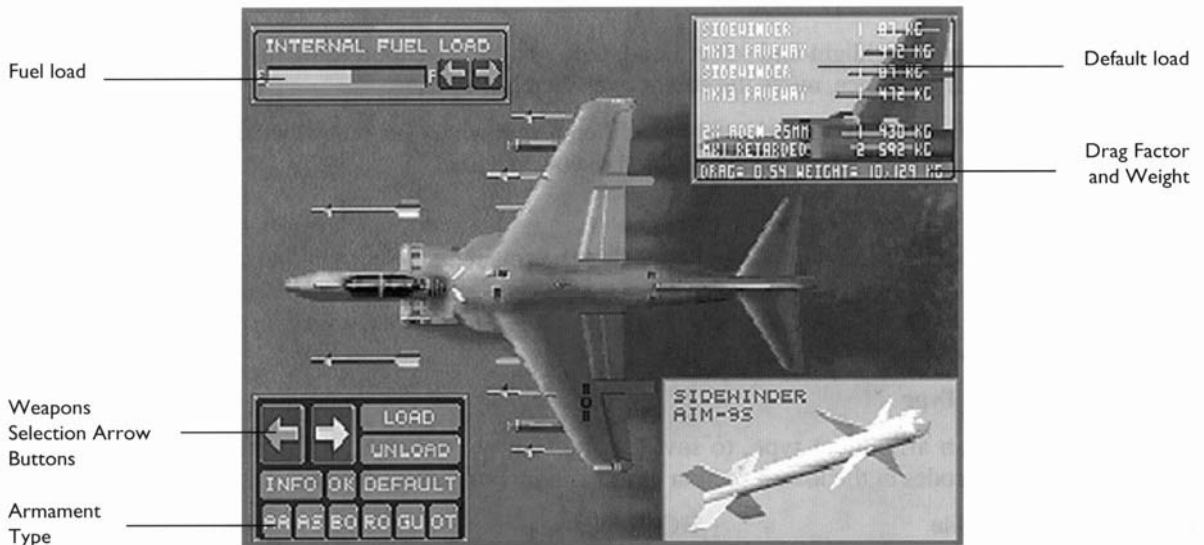
Exit the Map screen.

If you wish to change your default weapons or look at details of the missiles, bombs and rockets you must select the Arming Screen.

Select the Arming Screen (the pistol on the seat).

You will enter the Arming Section of *Harrier Jump Jet*. This will show a top-down view of your chosen aircraft (USMC AV-8B).

Select Change Payload.



The AV-8B Arming Screen

In the top right an inset box shows the default load that you have been assigned for your training mission. This includes details of type of ordnance, amount of fuel, cannon and the individual weights of each item. At the base of the box you are given a total drag factor and a combined take-off weight.

In this mission you will accept the pre-defined weapons load but in future missions, you may wish to change your payload so it's worthwhile taking time to look through the Arming Screen.

Arrow Buttons Left/Right

To view a complete selection of available weapons and supplies click on the left or right arrow buttons. A picture of the selected weapon is shown in a picture box on the lower right of the screen.

Unload

To unload any chosen weapon/store, select Unload then move the cursor over the Harrier wings.

Twin yellow boxes will appear to detail which weapons/supplies you wish to unload. Harrier ordnance is always fitted in pairs on each wing so in effect you need only highlight the lower wing.

When you have decided which weapon you wish to unload, make sure the yellow boxes are highlighting the weapon on the wing, then press the *selector*.

The weapon will be removed from the pylon.

Load

To load weapons/stores, highlight and select Load, then choose a weapon using the arrow buttons. Once you have chosen your ordnance, move the cursor over the Harrier wing.

If the weapon is appropriate to the selected pylon then a yellow box (or boxes) will appear in the correct spaces. Click with your *selector* and it will be added to your payload.

Info

Select the Info box to see information about your chosen armament. Select again to close the box.

Default Load

Select Default to reset your pre-defined payload.

Jump to Armament Type

You may jump to an armament type, to save having to cycle through all the weapons available, by selecting one of the codes in the lowest section of the arming box. The codes are:

AA Air-to-Air Missile

RO Rockets

AS Air-to-Surface Missiles

GU Guns/Cannons

BO Bombs

OT Other (Reconnaissance Pod, ECM etc.)

The default fuel load is shown in a box in the top left hand corner of the Arming Screen.

You may, if you wish, add extra fuel but remember that the heavier the fuel load, the less ordnance you can carry on your Harrier and the longer your take-off run.

Select OK when you have finished looking at the Arming Screen and you will be returned to the Mission Briefing Screen.

You are now ready to fly your first mission!

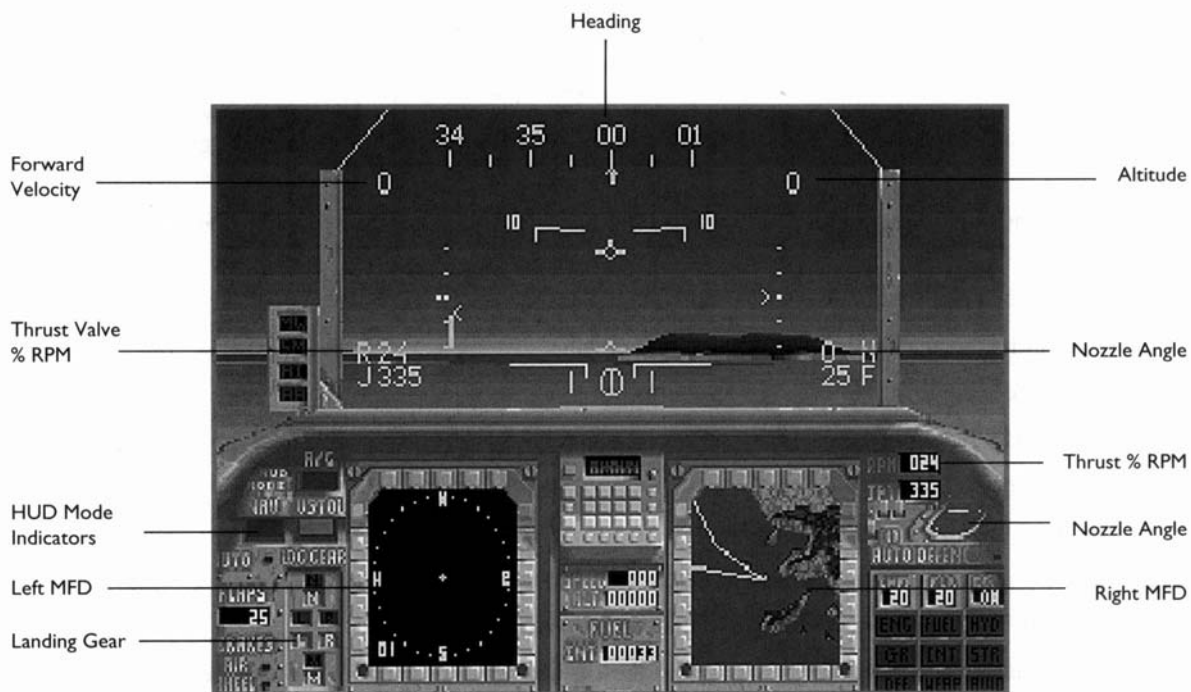
HARRIER JUMP JET

Flying the Harrier

To fly the Harrier (remember you chose to fly with the USMC AV-8B), simply select Fly in the Mission Briefing Screen.

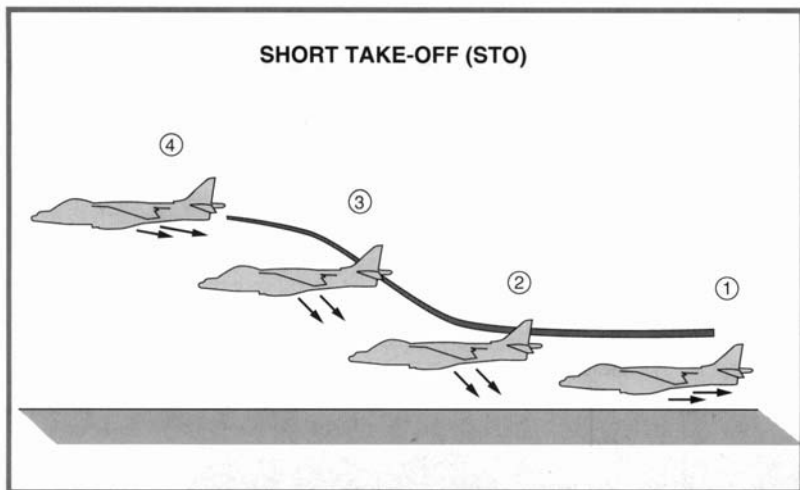
You will now be transferred to the cockpit of your Harrier.

The Harrier will be standing on its take-off area.



The Harrier cockpit in short take-off mode

You will now perform one of the unique Harrier manoeuvres: a short take-off.



Short Take-Off

Press Shift/ Plus +

Watch the numbers at the top left of the HUD increase. This is your forward speed.

When the speed reaches approximately 90 knots (this takes about 3 seconds) tap Open Square Brackets Key [once. This moves your jet nozzles down to an angle of 55°. You will begin to rise. Look at the increasing numbers on the top-right of the HUD. This is your height in feet.

After 2-3 seconds you must move your nozzles back to 0° (pointing backwards). Press Shift/Close Square Brackets] once.

You will now be in conventional wing borne flight.

Raise your landing gear (Key G). Flaps will auto activate.

Climb to 1000 feet.

Reduce thrust (RPM) to a cruise setting of 85%.

Set the Autopilot by pressing Key A.

Press ESC Key to pause the simulation.

This will give you an opportunity to study the cockpit displays.

Look at the HUD mode indicator lights on the extreme right of the cockpit.

The red light marked V/STOL will be lit. After take-off you should switch to NAV mode.

Press ESC to unpause the game.

Press the TAB Key until the NAV indicator lights up.

Notice that the Head Up Display superimposed on the front screen changes with each press. (For more details consult the HUD chapter in this manual).

HARRIER JUMP JET

You are now in Navigation mode, use this HUD when flying to and from the target.

You will notice a small block marker has lined up with the inverted tick mark on the middle of the HUD heading scale. This shows the direction of the first waypoint (Mission Ingress).



The Harrier Cockpit in Nav HUD Mode

Look at the three sets of figures on the lower right of the HUD. These indicate:

top- First Waypoint

middle- Distance to First Waypoint

bottom- Time in seconds to First Waypoint

Set Auto Defence (Key D). This will auto dispense Chaff/Flare defenses to confuse enemy missiles.

Take time to get used to all the views available in *Harrier Jump Jet*. Press function keys F1 to F6 for all-round views out of the cockpit. Press function key F8 then investigate the out-of-cockpit 'floating camera' views PgUp/PgDn/Insert/Delete. Press F3 to return to cockpit front view.

F1

F2

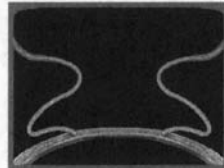
F3

F4

F5



F6



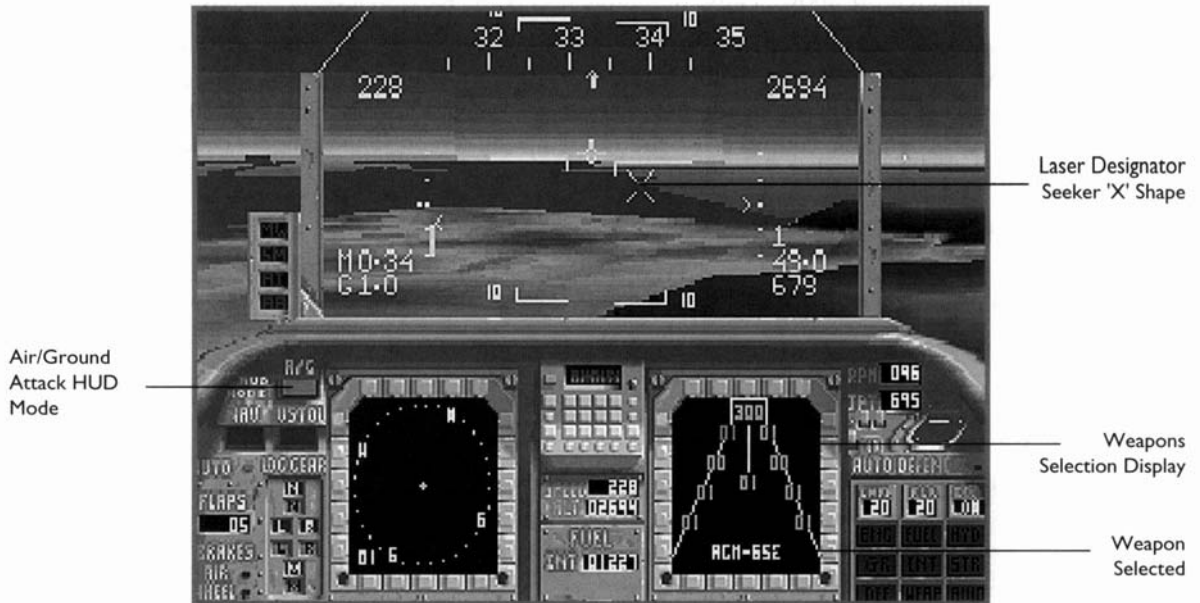
Press TAB to change HUD mode from NAV to A/G (Air/Ground attack mode).

Now, you must select the correct ordnance for your Primary Target (Ammunition Dump).

Press the Return Key until you have chosen Paveway GBU-16s (shown as a Pv16 on the HUD).

When you pass the Initial Point (Waypoint Two) to the Primary Target, Autopilot will turn you for the run-in to the target (Waypoint Three).

HARRIER JUMP JET



You will be above 1,000 feet and within 5 miles of the target.

You will see an X shape moving across the HUD.

Fly until you see waypoint 3. Then press Shift/Backspace to designate the waypoint as a target. The Track Cam (in right MFD) will show a picture of the target, the name of the target, its bearing and range.

The X shape will merge with a diamond shape and lock-on the target. Once you see this you may fire at will. A message will appear in the HUD if you are successful.

Remember that if you wish to 'unlock' a target press ALT/L.

You will now head for the second Initial Point (Waypoint Four).

Your Secondary Target is a truck formation. Your desired weapon is the Rockeye II cluster bomb.

Repeat the above procedure for weapon selection.

Select with the Return Key until you see 'rock' on the HUD.

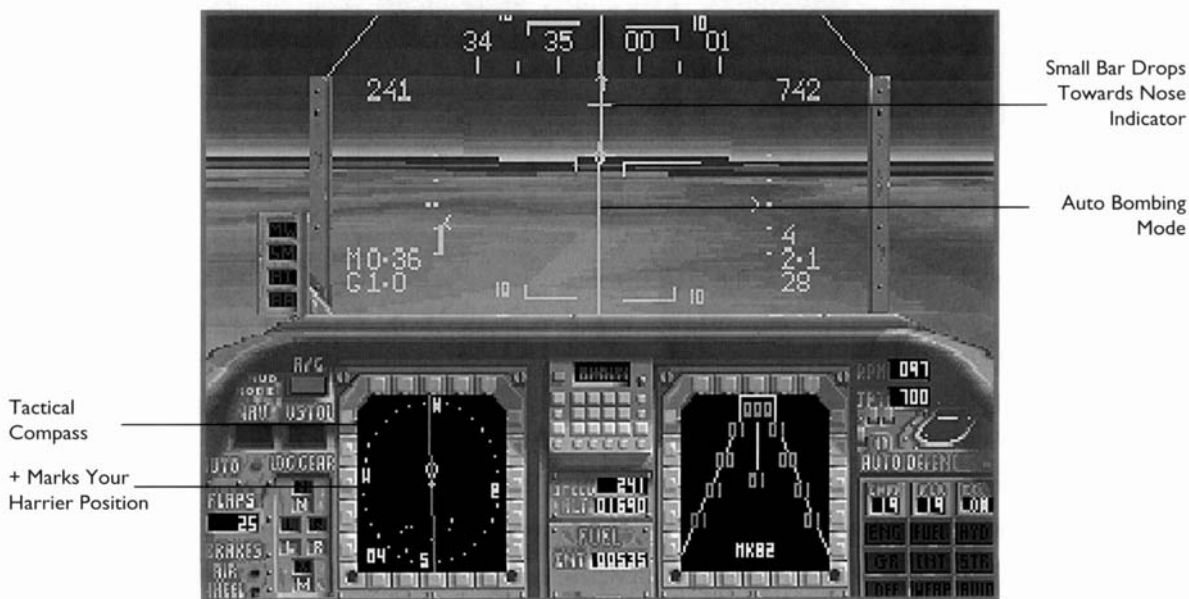
When you have completed the above. Pause the simulation (ESC Key) to look at the left-hand MFD.

This can also be cycled by pressing Key Z but we have chosen to keep this MFD on Tactical Compass Display setting. As you progress in difficulty levels, the importance of this display will become apparent but for the purposes of this guide be aware that a circle is a waypoint/target and a diamond a locked-on target. You will always be at the central cross and travel up the screen. The compass headings will rotate when you change direction.

Press ESC to resume the mission.

When you have passed the second Initial Point (Waypoint Four) you will begin the run-in to your Secondary Target (the truck formation).

Make sure your HUD mode is set to A/G (Air/Ground Attack Mode).



You will see a long vertical line across the HUD. In Simple Weapons Mode press Shift/Backspace to designate the target. A narrow horizontal line will descend towards the Nose indicator. Keep your finger pressed on the *Selector* as you approach the target and the Rockeye will auto drop on target.

HARRIER JUMP JET

After bombing your Secondary Target you will receive a message on your HUD.

Your Autopilot will take you to your Mission Egress Point (Waypoint Six).

On your way to the Mission Egress Point you may meet enemy aircraft.

Select Sidewinders (AIM-9S) with the Return Key.

A circle (boresight) will appear scanning the area ahead of you for aircraft targets. By pressing Key M you may 'uncage' the seeker and it will rotate.

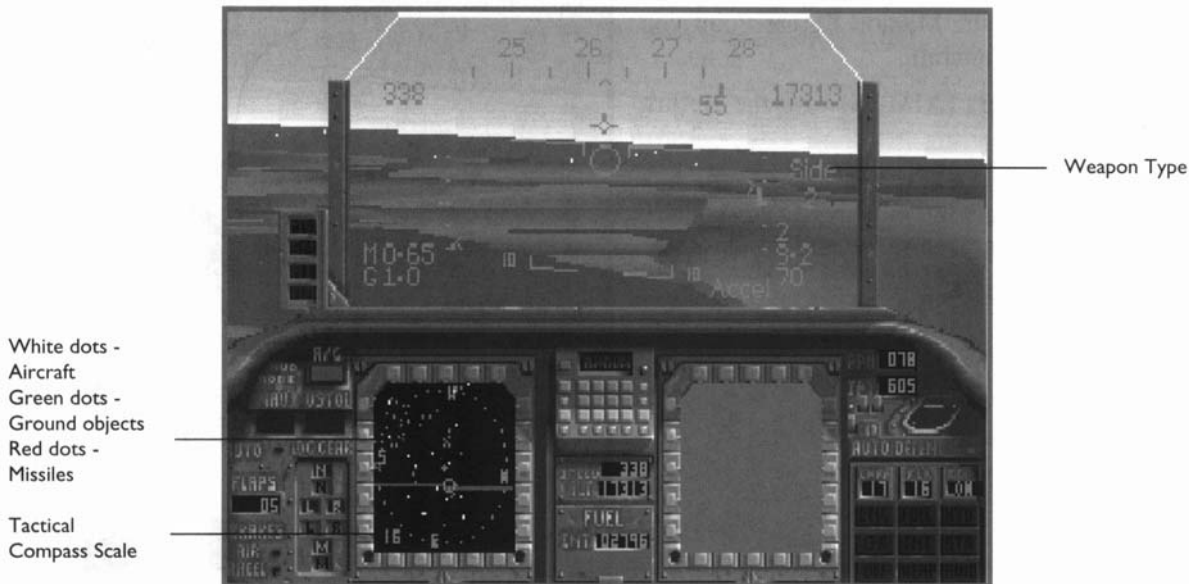
Turn off Autopilot (Key A)

Remember that in any Training Flight you can re-supply your Harrier by pressing keys Alt/R. This will fill the aircraft's fuel tanks and add extra weapons. Use Re-supply for sightseeing and target practice only.

Similarly, you may switch to Training mode at any time during play by pressing keys Alt/T; a useful function if things get confusing or you want to go sightseeing. Needless to say you will not receive any rewards/promotions for that particular mission.



Look at the Tactical Compass Display (left-hand MFD) to see details of enemy aircraft, ground objects and missiles.



The Tactical Compass can be scaled up x1,x2 x4, x8, x16 by pressing Key 6 or Key 5, or down with Shift 6 and Shift 5.

You are in easy weapons mode. Press Backspace to cycle through available targets. The Track Cam in the left MFD shows aircraft name, bearing and range. A circle with a diamond in it shows a locked target.

If you manage to lock-on an aircraft fire your Sidewinder with your *selector*.

If you want to 'unlock' a target (perhaps it's faster than you!) press ALT/L.

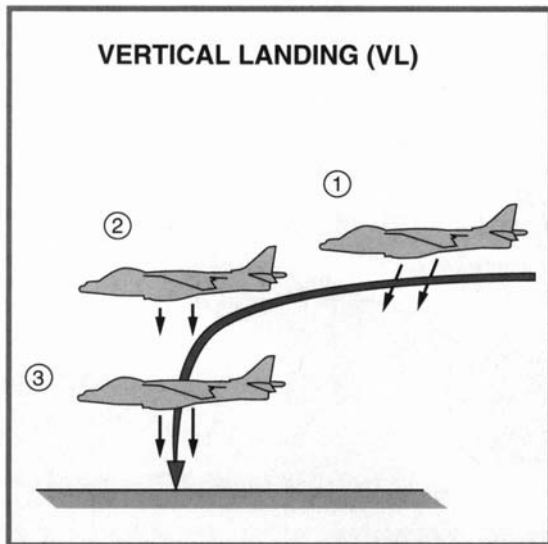
To return to base, select Autopilot again and complete your flight path by heading for Waypoint 7.

When you can see the runway, change your HUD mode to VSTOL (Press TAB key).

When you are over the landing site de-select autopilot, press the Auto Hover Key 0 (unavailable in Realistic Flight Mode).

HARRIER JUMP JET

Auto Hover will slow you down to a hover roughly over the landing site. Reduce power (Minus Key -) to descend. When you are on the ground press Shift/- to stop the engine.



Mission Egress/ Ingress waypoints are put into missions to make the Harrier flight path unpredictable to enemy trackers. Without Mission Ingress the enemy could draw a line from aircraft heading and guess the location of the target and alert defences around the target. Without Mission Egress points, the enemy could track the location of a Harrier base.



When you have landed you will be debriefed.

A summary of your mission will be shown in the Debriefing Room including recorded flight path, any use of ordnance and targets hit or destroyed.

Rewards and Promotions

In the Campaign game, you will be rewarded or promoted according to the structure of your chosen Air Force. However, there will be no rewards for training missions.

Repeat Training Missions

You are advised to perform several Training Missions until you understand the procedure of getting to the target and delivering your payload. Do not try to fly the Realistic Harrier Flight Model until you are familiar with the Simple and then the Easy Flight Model. The Realistic model is, in effect, the complete flight simulator.





SECTION

2



**THE
READY
ROOM**

HARRIER JUMP JET

THE READY ROOM

*The Ready Room***Pilot Roster: Keyboard****Select Pilot**

Select the pilot you wish to fly as from the list provided. If you are a new pilot erase a highlighted slot using the backspace/delete key and enter a name of your choice.

The pilots can be stored in various states. Dead, Retired, Missing-in-Action, POW Pilots are unavailable for play but can be deleted and their slots used for new pilots.

On Campaign/On Operations

If a pilot is On Campaign/On Operations in the middle of a game world, he can be selected and flown but only in his current game world. The player may reset the difficulty levels for the current campaign session.

Available

The pilot is between campaigns. He can be selected and flown.

The roster also shows full details of the Pilot's Air Force, Rank, Score, Best Mission, Last Mission Decorations and Aircraft Lost.

When you have completed your selection, press the Return Key.

New pilots must then choose their Air Force (US Marine Corps or RAF)

When you have made your choices, press Return to go back to the Ready Room.

Game Type: Large Screen

If you are starting a new game you can use your *selector* to choose between various difficulty levels:





HARRIER JUMP JET

Enemy Ground Troops:

Choose the level of opposition that you wish your forces to face on the ground by moving your *selector* and clicking on the appropriate box. The picture will change with a representation of the chosen level.

Green

Regular

Veteran

Elite

Enemy Pilots:

Choose the level of opposition that you wish your forces to face in the air by moving your *selector* and clicking on the appropriate box. The picture will change with a representation of the chosen level.

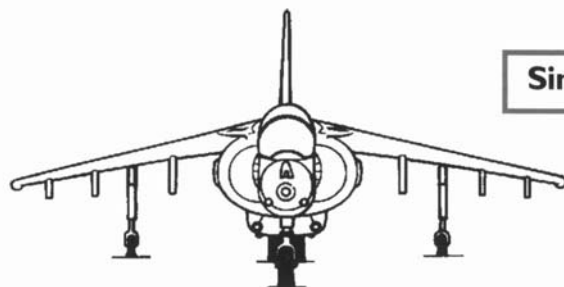
Green

Regular

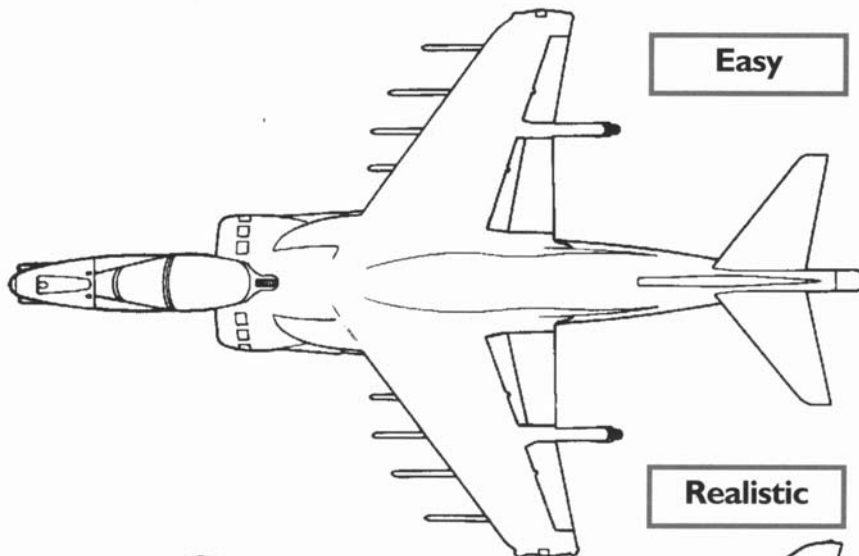
Veteran

Ace

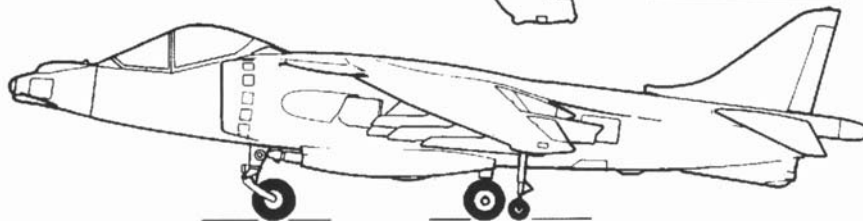
Flight Model:



Simplified



Easy



Realistic

HARRIER JUMP JET

Select the type of Harrier flight model you feel confident of flying.

Simplified

A good 'fun' version to train on and very forgiving with rookie pilots.

1. Weight and Drag of fuel or weapons will not be important factors. You are able to take-off vertically and have better manoeuvrability.
2. The effects of VIFFing are emphasized.
3. Amplified pitch and roll rate allows better dogfighting agility.
4. Auto Hover Mode available
5. The Yaw control is more effective in hover.

Easy

The next step up from Simple. A moderate level prior to tackling the Flight Simulator.

1. The weight and drag factor of on-board fuel and weapons is 50% realistic. This enables player to perform shorter take-offs and allows better manoeuvrability.
2. VIFFing effects are slightly increased so that a player experiences a 1 g upwards acceleration and a 1 g horizontal deceleration.
3. Pitch and roll rates are increased slightly allowing improved manoeuvrability.

Realistic (the Flight Simulator)

A real flight simulator of the USMC AV-8B or the RAF GR.7 that will react and fly like the real thing.

1. Fuel and weapons have realistic effects on performance. The Harrier must perform a rolling take-off to get airborne and manoeuvres best when it is carrying a small weapon load.
2. VIFFing results in a massive loss of speed. Turns are increased by 0.5 g.
3. The pitch and roll rates are accurately computed.
4. Lowering the Gear will have a realistic effect.
5. Lowering the airbrake will have a realistic effect.

6. Keeping rudder on whilst moving forward at speeds below 100 kts will flip the aircraft over.
7. You may have to dump fuel (Alt/F) when attempting a vertical landing. The maximum allowed on a Harrier that has expended all of its weapons is 3,062 kgs.
8. In air-to-air combat you may have to 'clean up' your Harrier pylons by jettisoning all air-to-ground weapons (Alt/J). This will increase your agility for dogfighting.

Landings:

Choose your landing difficulty level.

No crashes

No matter how bad your approach, or control, you will always land upright without any damage to your Harrier.

Any descent rate.

Any ground speed.

Any roll angle.

Easy

An option to choose if you wish to progress to Realistic Landings. Good for getting to know the controls, HUD and the feel of the plane in landing modes without incurring serious damage when you make an error.

Descent Rate max 2500 fpm

Ground Speed max 250 kts

Roll Angle max 45°

Realistic

Land the real Harrier by using all the available controls, dials and indicators. Not recommended for rookie pilots!

Descent Rate max 500 fpm

Ground Speed max 200 kts

Roll Angle max 10°

HARRIER JUMP JET

Weapons:

You can choose the effectiveness and realism level of the weapons carried on your Harrier.

Easy

Your missiles, rockets and bombs will be effective over a wide radius, will have 100% reliability, travel further and strike the target harder.

Laser-guided ordnance can be fired from any target approach angle. Sidewinders 'lock-on' from anywhere in the HUD.

You can cycle through all available targets by tapping Backspace (designate) Key. Bombs are always pre-set to 'Auto' mode.

Moderate

Weapons will lock-on realistically. Your missiles, rockets and bombs will be effective over a smaller radius and will have slightly less than 100% reliability. Laser guided ordnance locks-on if the target approach angle is within +/- 45°. Weapons will be slightly longer-ranged than realistic ones and strike the target a little harder.

Realistic

All weapons and supplies will behave as realistically as possible with an element of unreliability built in. You'll have to be accurate, precise and make the most of your numerous HUD aiming modes.

Game Type:

Select the type of game you wish your chosen pilot to experience. Click with your *selector* to cycle through the four options.

Training

A single training mission. By selecting this option you can attempt a sortie without worrying about outcome. Similarly, you will not receive awards or promotions if you are successful.

Single

A single sortie. One quick mission to take you into the game quickly but giving you the chance to build up promotions/rewards for your chosen pilot. Choose this option if you wish to progress to full campaign mode but want to sharpen up your Harrier control capabilities.

Day

A full campaign day in control of your own Harrier. The number of sorties in a day may vary to a maximum of eight. Perform a quick sortie as ordered, then return to your base site to await further orders. There may only be enough time left to refuel, re-arm then take-off again. You will be given updates of the status of the campaign and the effect your actions are having in that day's battle.

Campaign

The full *Harrier Jump Jet* campaign in the game world of your choice. A campaign is made up of a series of 'days' (see above) and can last for 10 days. You are advised to avoid the full campaign until you have gained experience of all Harrier controls and tactics.

World: World Map

By *selecting* the World Map, you will see a full screen world map. You may choose any game world but remember that some campaigns are more difficult than others. Select one of the three Game World options:

Hong Kong

The lowest level of difficulty. The campaign against the People's Republic of China in conflict over Hong Kong.

Falklands

A moderate level of difficulty. The campaign against the re-equipped Argentine forces over the Falkland Islands.

Nordkapp

The highest level of difficulty. The campaign against a new hard-line Russian Republic across the wastes of Scandinavia's North Cape. You are not advised to attempt Nord Kapp at campaign level if you have not already succeeded in one of the previous game worlds.

HARRIER JUMP JET

Fly: Combat Monitor

By selecting this option you can jump into your Harrier immediately without consulting mission briefing, maps or orders. This option can be used by pilots new to *Harrier Jump Jet* who want to fly around the game world as quickly as possible, or experienced pilots who want to by-pass the briefing screens.

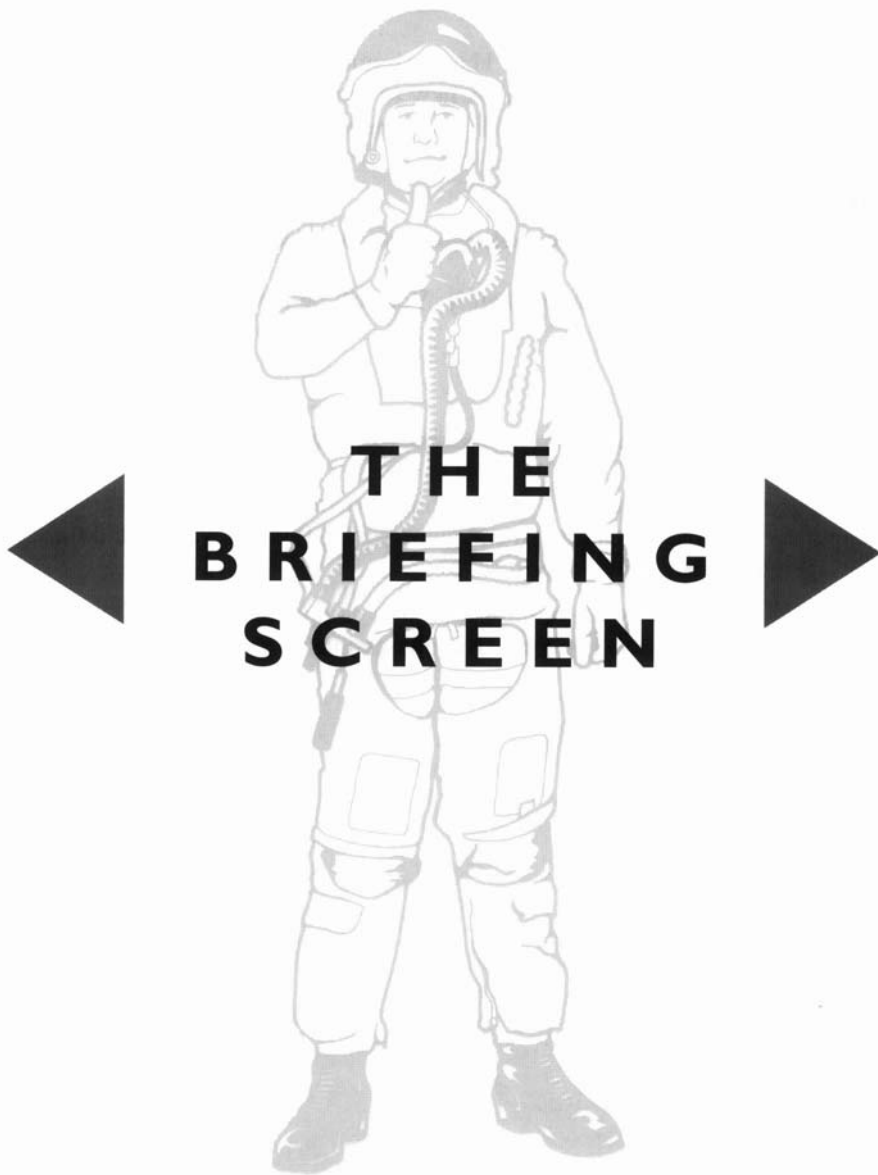
Quit: Exit Sign

Allows you to exit from the simulation immediately. You will be returned to your computer's operating system.

Briefing: Papers

Select this action area in order to move to the Briefing Screen. Be aware that the Briefing Screen will change depending on your choice of campaign and game world. If you have selected the Training Option, you will be taken to the Field Briefing Screen.

Other Briefing Screens will reflect your position during a campaign; for example, in a 'hide', or on an aircraft carrier. But the details accessed in these Briefing sessions will always remain the same.

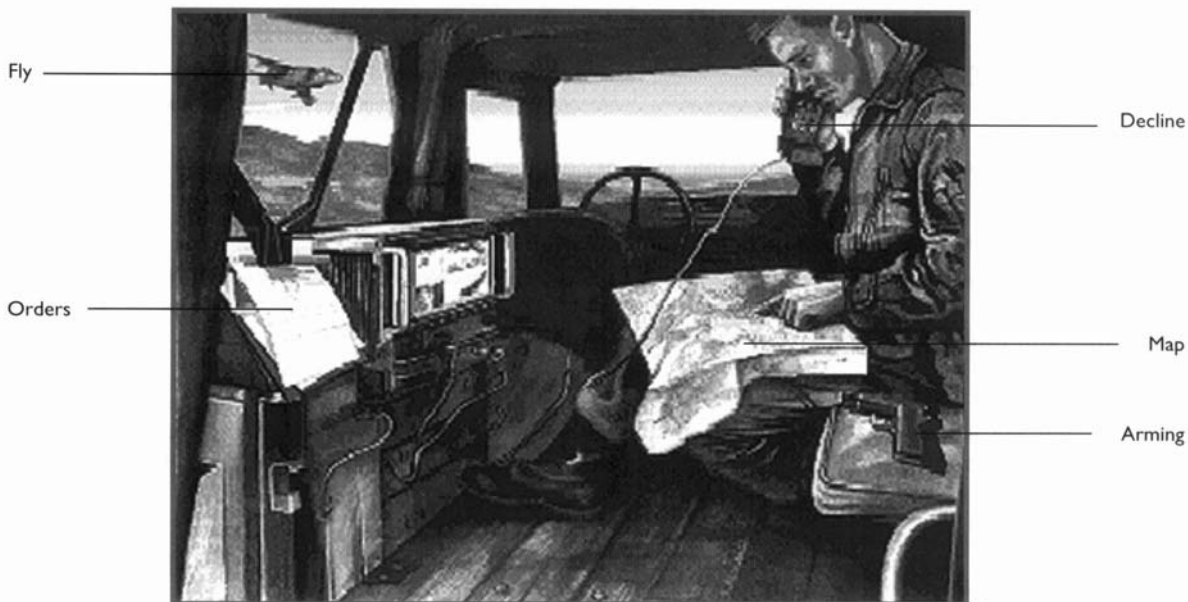


**THE
BRIEFING
SCREEN**



HARRIER JUMP JET

THE BRIEFING SCREEN



The Mission Briefing Screen

Continuing A Campaign

If you are continuing a campaign, you will be given a summary of the background war scenario in your chosen area of conflict.

Campaign Status: Clipboard

If you are in the middle of a saved campaign, you will begin the session with an Operational Status Clipboard. This will update you on your position in the simulation. You will also receive new Orders and Suggested Ordnance.

New Campaigns

The site for the Mission Briefing Screen will change depending on your chosen campaign but in all cases you can access similar functions (e.g. Arming, Map etc.) by moving the *selector* cursor around the screen.

Briefing Session

An 'in-the-field' Mission Briefing Screen that will vary depending on the Mission/Campaign Type.

Review Orders

In all cases you will have the opportunity to review your orders. Details shown are:

Mission Type

One of eight Harrier mission types. Five air-to-ground attack (Deep Strike, Battlefield Interdiction, Ground Support, Iron Hand, Reconnaissance) and three air-to-air (Combat Air Patrol, BARrier CAP, Air Intercept). For more details see the Mission Types chapter in this manual.

Callsign

Shown as: Callsign-Flight number-Aircraft number

Take-off Time

Local Time for area of conflict

Zulu Time- military term for Greenwich Mean Time (GMT).

Day

For Campaigns only. The Campaign day number.

Take-off Base

Name of Base and Grid Reference given.

Landing Base

Name of Base and Grid Reference given.

HARRIER JUMP JET

Mission Summary

Air Patrol Routes listing waypoints and Grid References.

Air Intercept Routes listing waypoints and Grid References.

Primary/Secondary Ground Targets listing waypoints and Grid References.

For all ground attack targets Initial Point Offset (IP to Target distance) is also given.

By clicking on the Next button you can view page two with details of:

Total Stores Carried

Day/Night/Twilight conditions

Visibility Details

Wind Speed and Wind Bearing

Enemy Activity

The pre-set weapons appropriate for that particular mission and an estimate of your fuel needs. You can always change these settings in the Arming Screens.

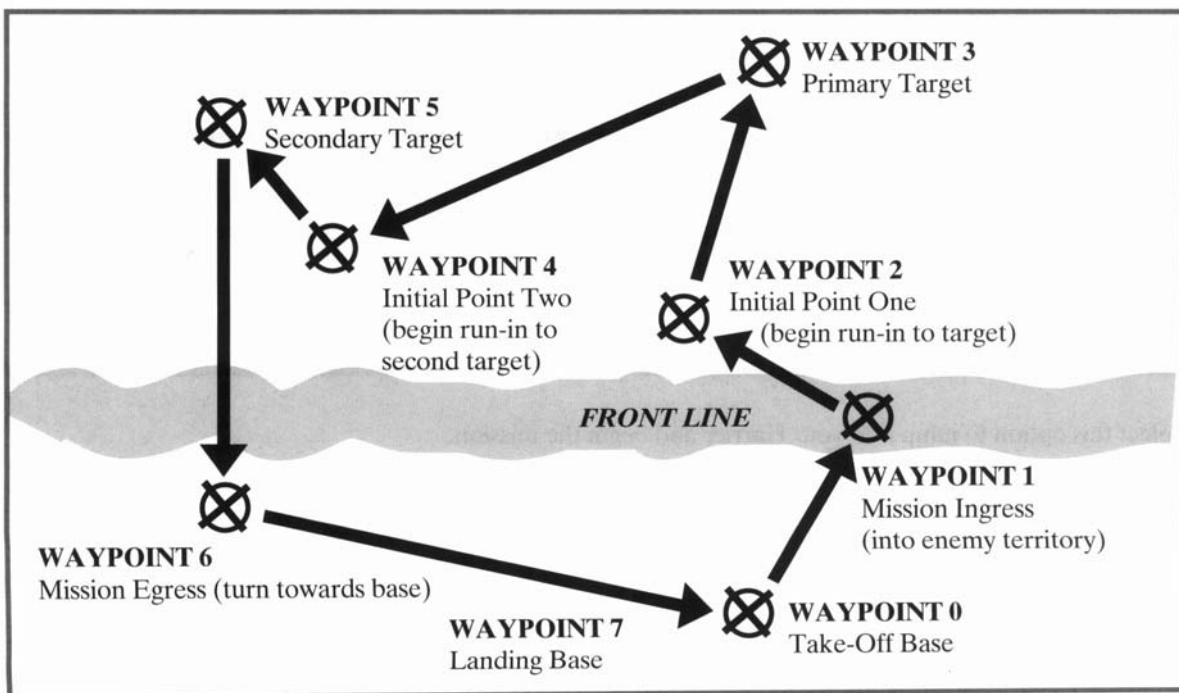


Diagram of a typical ground attack mission

Map on Screen: View the Campaign Map

A large scale map of the combat area with an overlay of your flight path, waypoints, targets/patrol routes, bases and the latest intelligence summary of enemy forces. Click on the Next Waypoint icon to see flight path and waypoints.

Red crosses are enemy ground installations

Green crosses are friendlies

Yellow crosses are assigned targets

Blue crosses are friendly bases

Arming

If you wish to change your default weapon load or look at details of the missiles, bombs and rockets select this option and exit to the Arming Screen.

Decline Mission

An opportunity to decline a particular mission and return to the Ready Room. You are advised not to decline missions except under exceptional circumstances because you will be penalized and your prospects of promotion severely affected!

Fly

Select this option to jump into your Harrier and begin the mission.

HARRIER JUMP JET

Mission Egress/Ingress waypoints are put into missions to make the Harrier flight path unpredictable to enemy trackers. Without Mission Ingress the enemy could draw a line from aircraft heading and guess the location of the target and concentrate defences around the target. Without Mission Egress points, the enemy could track the location of a Harrier base.



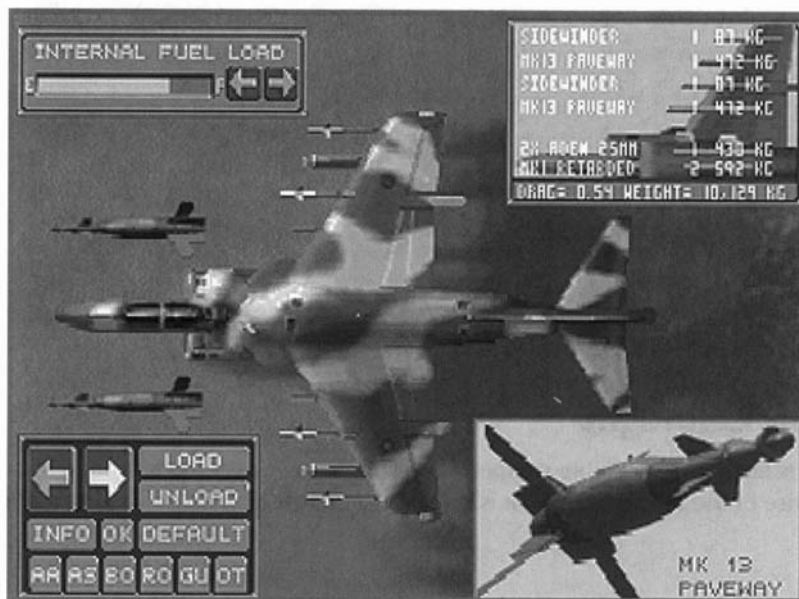


**ARMING
THE
HARRIER**

HARRIER JUMP JET

ARMING THE HARRIER

The Arming Screen

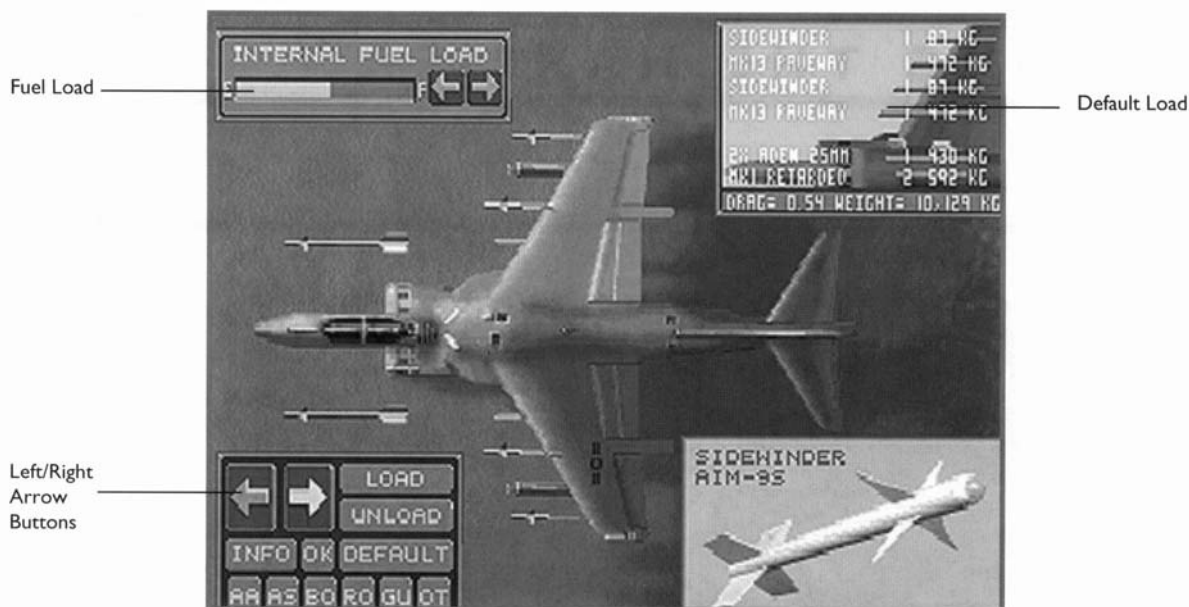


The RAF GR.7 arming screen

By selecting Arming from any Mission Briefing screen, you will enter the Arming Section of *Harrier Jump Jet*. This shows the selected Harrier (USMC AV-8B or RAF GR.7).

In the top right an inset box shows the default load that you have been given for that particular mission. This includes details of type of ordnance, amount of fuel, cannon and the individual weights of each item. At the base of the box you are given a total drag factor and a combined take-off weight. These are more important if you are flying the realistic aircraft model.

Note that *Harrier Jump Jet* simulates USMC and RAF weapons and that certain types of ordnance are only available to specific Harrier types.



The USMC AV-8B arming screen

Arrow Buttons Left/Right

To view a complete selection of available weapons and supplies click on the left or right arrow keys with your *selector*. A picture of the selected weapon is shown in a picture box on the lower right of the screen.

Unload

To unload any ordnance/stores select Unload then move the cursor over the Harrier wings. Twin yellow boxes will appear to detail which weapons/stores you wish to unload. Harrier ordnance is always loaded on each wing so in effect you need only highlight the lower wing. When you have decided which weapon you wish to unload, make sure the yellow boxes are highlighting the weapon on the wing then press your *selector*. The weapon will be removed.

Load

To load weapons/stores, highlight and click on Load, then choose a weapon using the arrow buttons. Once you have chosen your ordnance, move the cursor over the Harrier. If you have space for that weapon then yellow boxes will appear in the appropriate spaces. Click with your *selector* and it will be added to your payload. Repeat the procedure for all your chosen ordnance.

HARRIER JUMP JET

Info

Select the Info box to see information about your selected armament. Select again to close the box.

Default Load

Select Default to re-select the pre-defined payload.

Jump to Armament Type

You may jump to an armament type, to save you having to cycle through all the weapons available, by selecting one of the codes in the lowest section of the arming box.

The codes are:

AA Air-to-Air

AS Air-to-Surface

BO Bombs

RO Rockets

GU Guns/Cannons

OT Other (Reconnaissance Pod, ECM etc.)

Internal Fuel Load

The default fuel load is shown in a box in the top left hand corner of the Arming Screen. You may, if you wish, add fuel (Left/Right Arrows but remember that the heavier the fuel the less ordnance you can carry on your Harrier and the longer the take-off run.

OK

Select OK when you have completed your choice of payload and want to exit the Arming Screen.



A pilot checks the arming of a MK.82 Snakeye bomb on his Harrier



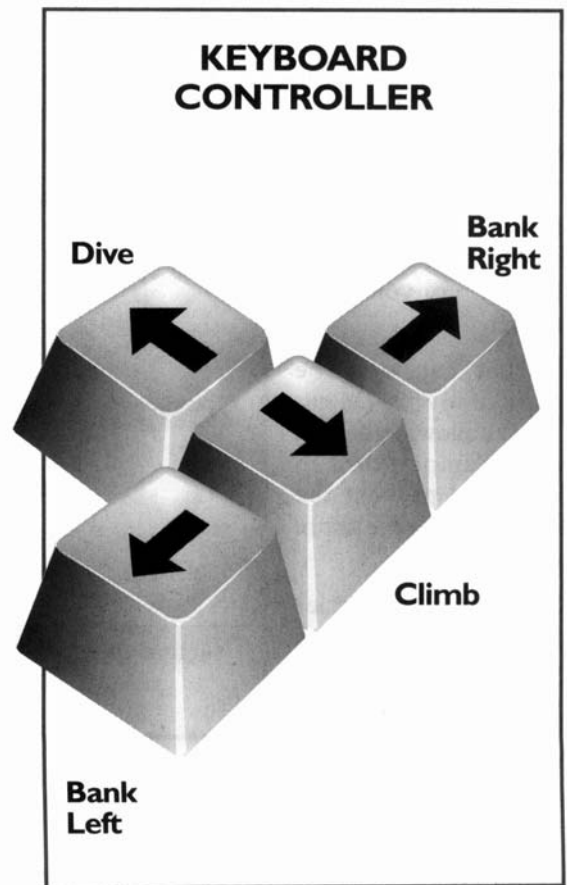
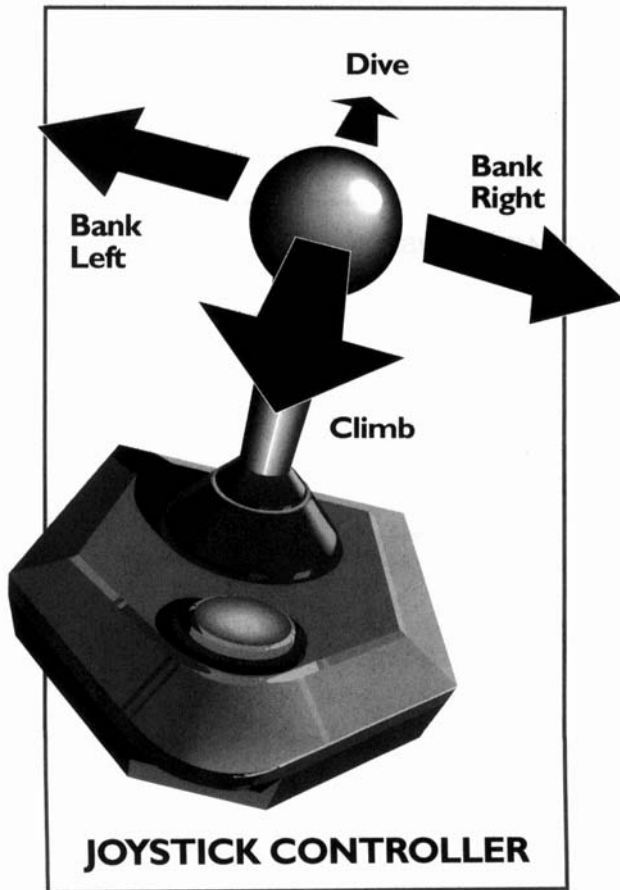
**FLIGHT
CONTROLS**



HARRIER JUMP JET

FLIGHT CONTROLS

The Flight Controllers



Short Take-Off (STO)

To go into action at maximum weight, the realistic flight model Harrier *must* undertake a short take-off. However, once weapons and fuel have been used up (or dumped) the aircraft can land vertically in any restricted space.

Short (rolling) take-off is initiated with full flaps that activate automatically when the landing gear is down. A normal take-off roll with engine nozzles pointed directly behind (0°) provide maximum thrust then, at a pre-set speed (90 knots), a pre-defined nozzle angle of 55° is selected by tapping nozzle Key Open Square Brackets [once.

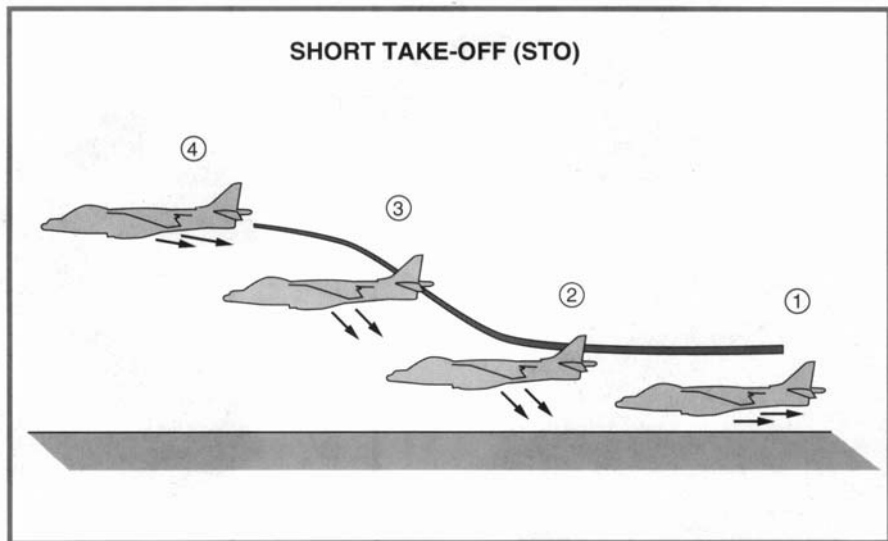
Under the effects of wing lift and jet thrust lift, the aircraft climbs into the air.

When the Harrier has accelerated to normal flying speed, the pilot reduces the nozzle angle to 0° by pressing Shift/Close Square Brackets] once, then raise the landing gear (Key G). Flaps will retract automatically.

From this point the Harrier should be flown like a conventional fighter.

Thrust can now be reduced to 85% (Minus - Key) allowing the Jet Pipe Temperature to drop and prevent the Pegasus engine from overheating.

STO allows a Harrier loaded with eight tons of weapons and fuel to take-off using about 1000 feet of firm, reasonably flat terrain.



HARRIER JUMP JET

The Three Flight Models

There are three distinct flight models in *Harrier Jump Jet*.

Simplified Model

A fun version to train on and very forgiving with rookie pilots.

1. Weight and Drag of fuel or weapons will not be important factors. You are able to take-off vertically and experience better manoeuvrability.
2. The effects of VIFFing are emphasized.
3. Amplified pitch and roll rate allows better dogfighting agility.
4. Auto Hover Mode (Key 0) available
5. The Yaw control is more effective in hover.

Easy Model

A good version to train on before attempting the Flight Simulator.

1. The weight and drag factor of on-board fuel and weapons is 50% realistic. This enables the player to perform shorter take-offs and allows better manoeuvrability.
2. VIFFing effects are slightly increased so that a player experiences a 1 g upwards acceleration and a 1 g horizontal deceleration.
3. Pitch and roll rates are increased slightly allowing improved manoeuvrability.

SHORT TAKE-OFF SUMMARY

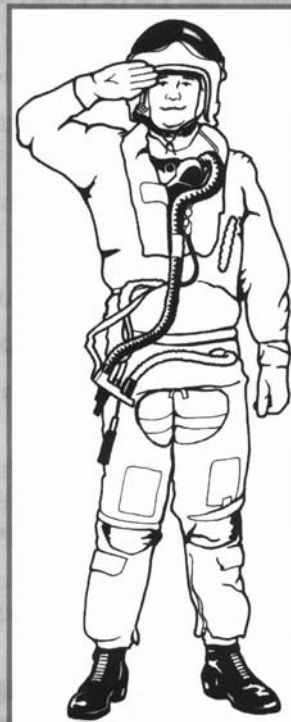
Press Shift/ Plus+ to set thrust to maximum.

At 90 kts tap Open Square Brackets Key [once. Altitude will rise.

After 2-3 seconds, press Shift Close Square Brackets Key] to set nozzles to 0°.

Raise Landing Gear Key G.

Reduce thrust to approximately 85% (Minus Key -).



Realistic (the Flight Simulator)

A real flight simulator of the USMC AV-8B and the RAF GR.7 that will react and fly like the real thing. Pay particular attention to the following:

1. Fuel and weapons have realistic effects on performance. The Harrier must perform a rolling take-off to get airborne and manoeuvres best when it is carrying a small weapon load.
2. VIFFing results in a massive loss of speed.
3. The pitch and roll rate are accurately computed.
4. Lowering the Gear will have a realistic effect.
5. Lowering airbrakes or flaps will have a realistic effect.
6. Keeping rudder on whilst moving forward at speeds below 100 kts will flip the aircraft over (not recommended!).
7. You may have to dump fuel (Alt/F) when attempting a vertical landing. The maximum allowed on a Harrier that has expended all of its weapons is 3,062 kgs. If you land with weapons, remember that the weight of the weapons is important.
8. In air-to-air combat you can 'clean up' your Harrier pylons by jettisoning all air-to-ground weapons (Alt/J). This will increase your agility for dogfighting.

Vectoring in Forward Flight (VIFFing)

In general VIFFing is used to slow down the Harrier rapidly. This manoeuvre means that a potential attacker on your tail will overshoot and give you the advantage in a dogfight.

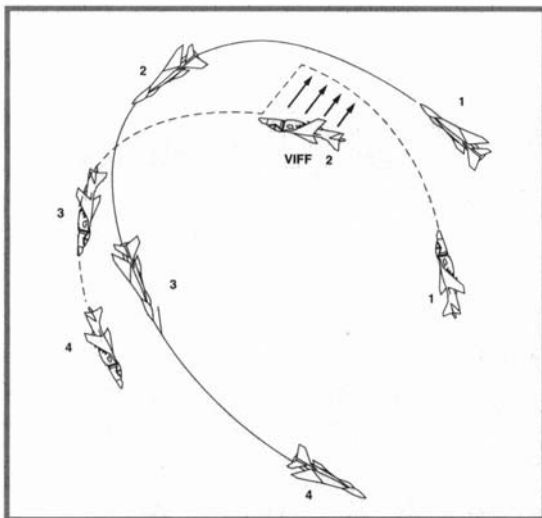
Press **Shift/Open Square Brackets [**.

Jet nozzles will swing to 98° and there will a rapid deceleration experienced by the Harrier.

When the attacker zooms past press **Shift/Close Square Brackets]** to rotate the jet nozzles back to 0°.

(See **Dogfight** in Section 3.)

HARRIER JUMP JET



The first VIFFing manoeuvre was carried out by Lt. Col Blot of the US Marine Corps at 500 kts, in level flight. He had not tightened his shoulder straps because he did not anticipate any major effects and simply pulled the jet nozzles lever to the rear stop, and (as he describes it),

"...the airplane started decelerating at an alarming rate, the magnitude of which I could not determine because my nose was pressed up against the gunsight. I was now straddling the stick, with my right hand extended backwards between my legs, trying to hold on for dear life."



Vertical Take-Off

(Only possible in Simple Flight Model or when carrying zero payload and low level of fuel)

Press (and hold down) **Open Square Bracket Key [** to select 82° nozzle angle.

Press **Shift/Plus +** to set thrust to maximum.

When you have risen to 100 feet, ease back on the nozzle angle press **Close Square Bracket Key]** gently.

The Harrier will accelerate in a forward direction without losing height until it achieves conventional wing-borne flight and the nozzles are pointing backwards 0°.

Hovering



An RAF Harrier hovers between the trees towards its 'hide'

HARRIER JUMP JET

Hovering is important when performing landings in restricted spaces.

Remember to dump excess fuel (**ALT/F**). If all weapons have been expended you can have a maximum load of 3,062 kgs of fuel on-board.

Use thrust **Plus Key + / Minus Key -** and nozzle angle **Open/Close Square Brackets [or]** to stabilize.

Use rudder **Keys < or >** to turn in hover.

You can attempt hovering in all flight models but in Simple Flight Model **Key 0** will enable Auto Hover (reducing thrust and nozzle angle to 82° automatically).

Flying Backwards

All Harrier flight models can fly backwards but this is very difficult and dangerous exercise for rookie pilots in the Realistic Flight Model. Fly backwards to reposition your aircraft when landing. Do not attempt to fly backwards for any length of time!

Take-off vertically (as above)

Press **Open Square Bracket Key [** to select 82° nozzle angle.

Press **Shift/Plus +** to set thrust to maximum.

When you have risen to 100 feet, ease further forward on the nozzle angle **Open Square Bracket Key [** to 98°.

Watch the Airspeed Indicator. When it shows a minus value, you are flying backwards!

Vertical Landing

Simple Flight Model

HUD mode to VSTOL (Press **TAB** key).

When you are over the landing site, press the Auto Hover **Key 0** (unavailable in Realistic Flight Mode).

Auto Hover will slow you down to a hover roughly over the landing site. Use your *controller* to fine adjust movement then reduce power (**Minus Key -**) to descend, and Shift/- to stop the engine.

Easy/Realistic Flight Model

Jet nozzles are used to slow down the Harrier and thrust is used to keep altitude as the aircraft stays in hover. When in hover, wing, nose and tail reaction control jets take over control and allow the Harrier to 'translate' (move) in any desired direction.

Dump any excess fuel (**ALT/J**) before attempting a landing. If you have no weapons on-board the maximum fuel you can carry is 3,062 kg.

Change HUD mode to V/STOL (**TAB Key**)

Press **Shift/Open Square Brackets [** to set nozzles to 98°.

Keep the nose up 8°.

With Airbrakes (**Key B**) and reduced thrust (**Minus Key -**) slow down to 20 knots.

Lower Gear (**Key G**). Flaps will extend automatically.

Set nozzles to 82° (hold down **]** Key).

Hover over landing site/runway.

Line up nose and 0° pitch lines on HUD.

Slowly reduce power to land (**Minus Key -**).

Keep the Side Slip Indicator circle in the centre mark by using Rudder **Keys < or >**.

Landing should be very slow.

HARRIER JUMP JET

In normal flight the Harrier is controlled by ailerons, rudder and an all-moving tailplane. However, in hover or minimal jet flight, which takes place below normal aerodynamic stalling speed, normal controls are not effective and the Reaction Control System takes over.

RCS is a system of puffer jets which controls the aircraft in roll, pitch and yaw and is linked to the Harrier's rudder pedals and control column. This means that, even in hover, the pilot can fly the Harrier like any normal aircraft, giving the pilot a feeling of the continuity of control.





**HEAD-UP
DISPLAYS**

HARRIER JUMP JET

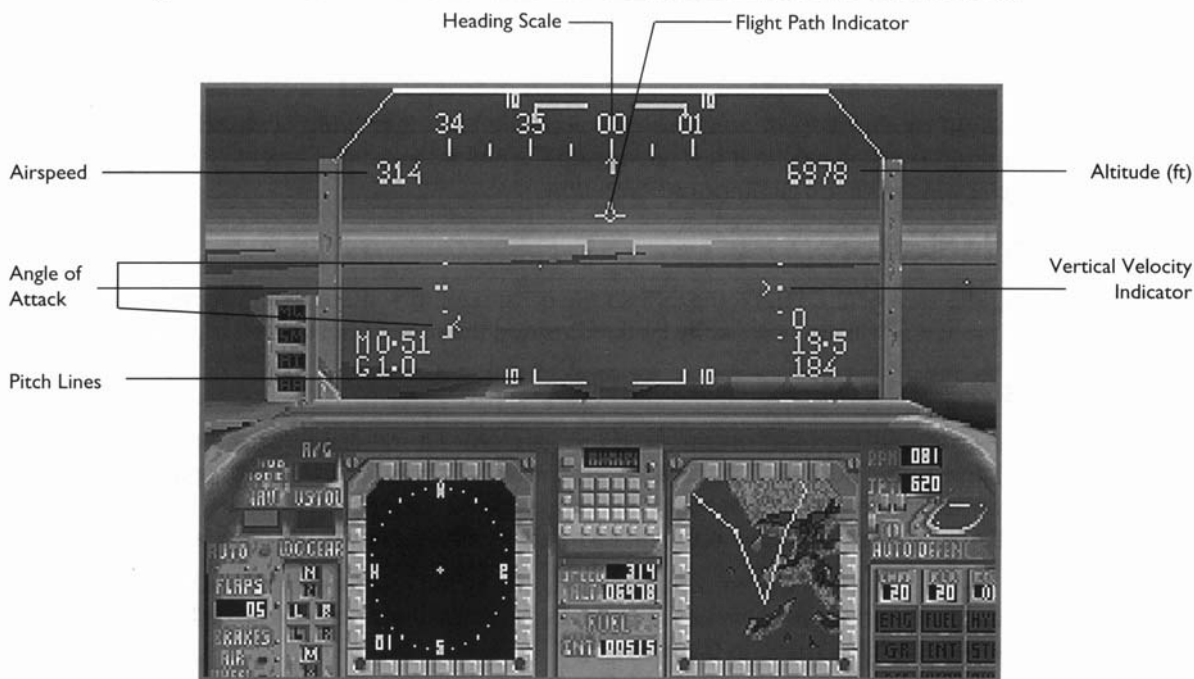
HEAD-UP DISPLAYS

General HUD Indicators

The *Harrier* cockpit has a number of HUD modes depending on the chosen function: take-off, landing, navigation or weapon delivery. At first these HUDs will seem confusing and it is recommended you follow the First Mission Tutorial carefully to introduce you to the differences in the three basic HUD modes. You are also advised to experiment with changing HUD modes as you read this chapter and to become familiar with all the display indicators.

Don't worry about getting things wrong. Remember that *Harrier Jump Jet* is an extremely accurate simulation and you will be undergoing the same learning process as that of a real pilot.

The following is a list of HUD indicators that remain constant no matter the chosen mode.



HUD indicators that remain constant in all modes

Heading Scale

The tick mark at the centre indicates the direction you are travelling in: 00° is North, 90° is East, 180° is South and 270° is West.

Airspeed

The horizontal speed of the Harrier through the air (in knots) is shown on the left of the HUD. Remember that a zero value means you are either at rest or hovering and a minus value means the aircraft is moving backwards.

Angle of Attack

The angle of airflow across the wings. The double dots mark the point of maximum lift. The top and lower ends of the scale indicate zero lift.

Altitude Indicator

A digital read out of your altitude upto 5,000ft, this is a *radar* altimeter showing height above ground level. Over 5,000ft above ground level, this indicates the *barometric* altitude above sea level.

Vertical Velocity Indicator

The VVI extends up or down from a centre tick mark on the right hand scale. If it is extending downwards the aircraft is losing height, if it is moving up the aircraft is gaining height. The longer the bar the faster the rate at which you are climbing or descending.

Flight Path Indicator

Usually in the middle area of the HUD, the FPI shows the direction you are flying when in wing borne mode. Remember that this will not necessarily be the direction the nose of the aircraft is pointing in.

Pitch Lines

Pitch lines are always superimposed on the HUD to give you an indication of the position of your Harrier's nose relative to the horizon. They are extremely useful if your aircraft nose is pitched so far up or down that the horizon is invisible. Each major line represents 10° of pitch up or down. If your aircraft is level, pitch is 0°. If your aircraft is climbing straight up or diving straight down, the pitch is 90°.

The pitch ladder always 'points' to the horizon. Roll is shown by the relationship of the horizon, or pitch line, to the cockpit. If the horizon or pitch line is perfectly horizontal, your craft is level. If the line angles to the left or right, your craft has rolled to the left or right.

HARRIER JUMP JET

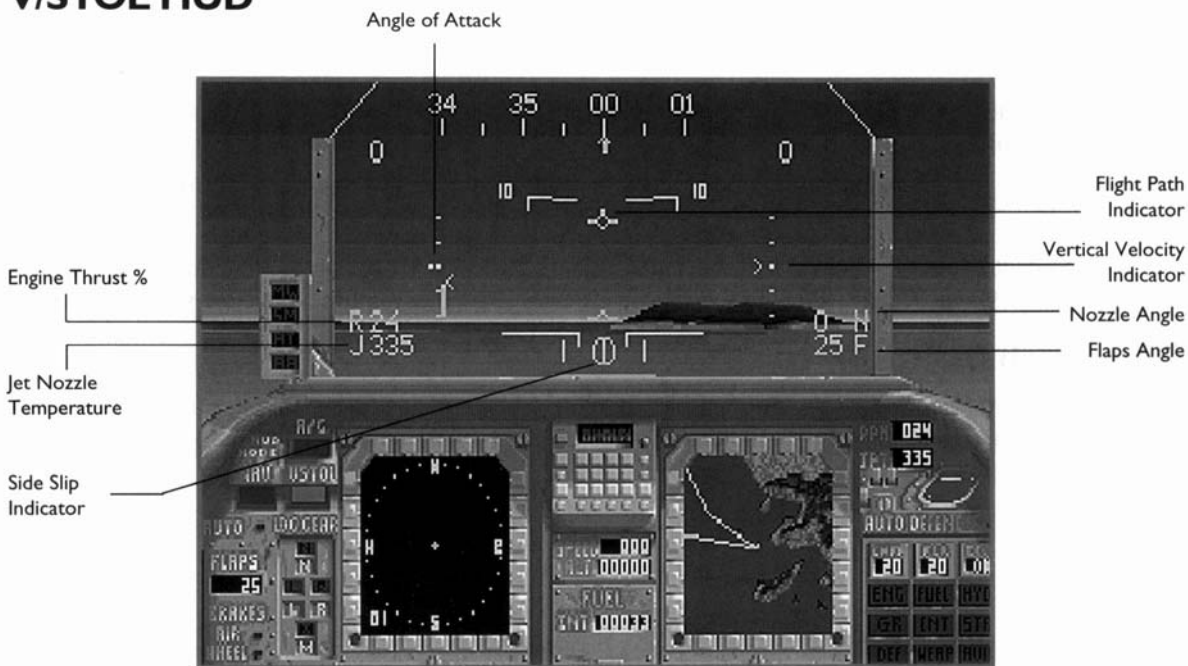
In addition, the Harrier HUD pitch lines indicate degree of climb, or dive, by 'pulling' towards the horizon.

Specific Function HUDs

Harrier Jump Jet has extremely accurate HUD modes and this means that you will have to switch modes when performing various tasks.

Press the TAB Key to cycle through the three modes.

V/STOL HUD



The short take-off/landing HUD

This HUD is used for all take-offs and landings. It includes all the general HUD details (see above) and, in addition, there are the following indicators:

Side Slip Indicator

A three-line scale with a circle based on the centre line to indicate side slip.

In Realistic Flight Mode too much side slip in VSTOL manoeuvres (if the circle touches the outer bars) will result in the Harrier slipping, turning over and crashing to the ground. To compensate for side slip apply Rudder left (Key <) or right (Key >).

R value

Engine thrust (RPM) value as a percentage.

J value

Jet Pipe Temperature. The temperature of the jet nozzles. Engine damage may result from overheating so keep an eye on this indicator (repeated on the cockpit). Remember to reduce thrust to a workable rate (80-85%), using the Minus Key-, to prevent overheating.

N value

Shows the Nozzle Angle of the four jet nozzles on your Harrier. All four nozzles turn at the same rate. Pressing keys Shift/Close Square Brackets] will point the nozzles to the rear for wing borne flight.

Tapping Key [is the nozzle key for short take-offs. This is used to rotate the nozzles to the pre-set take-off angle (55°).

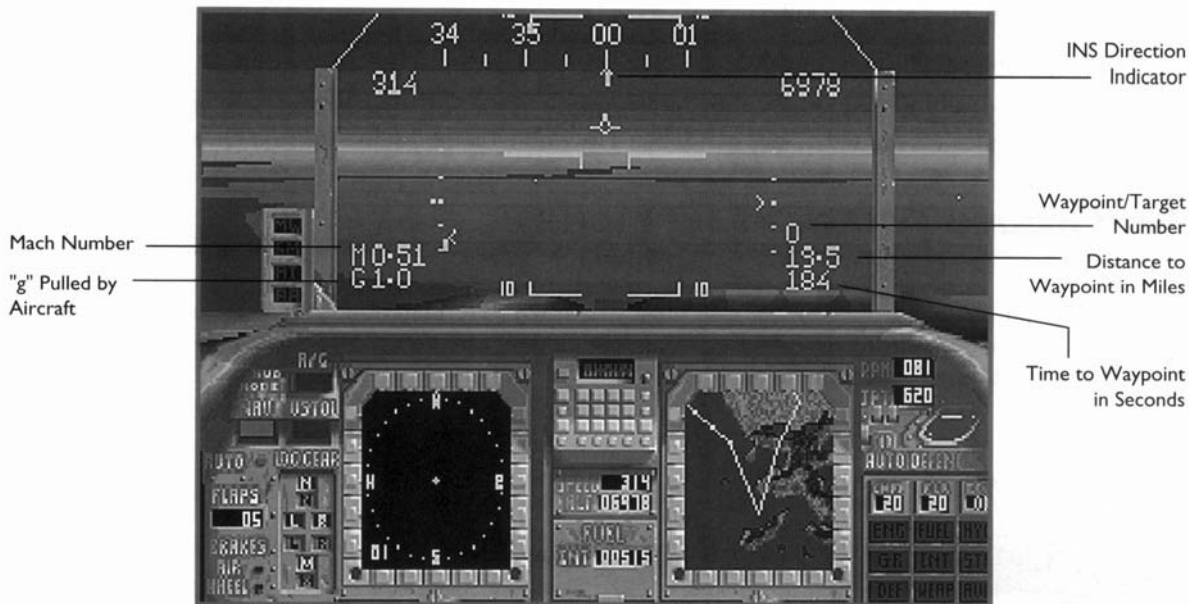
For finer control of nozzles hold down the Open Square Brackets [Key (0° to 98°) and Close Square Brackets] Key (98° to 0°). By using these keys you are able to set any required angle for your nozzle jets.

Flight Path Indicator

When in landing/take-off mode, the FPI will rise and fall as you tip the nose up/down. If the FPI is on the horizon, the Harrier is level. Use this indicator to line-up the Harrier on a landing site to perform a short landing.

HARRIER JUMP JET

NAV HUD



The NAV HUD is used for all navigation functions

Inertial Navigation System (INS) Direction Indicator

The marker on the top of the scale shows the heading you should fly to reach the currently selected waypoint/target. To get 'on-course' turn until the marker is below the middle tick on the scale.

A number below the INS Indicator shows the heading to the next waypoint/target.

Engaging Autopilot (Key A) will always automatically line up the INS Direction Marker.

M value

An Airspeed Indicator shown as a Mach number.

g value

The amount of g 'pulled' by the aircraft. When the Harrier is 'parked' this will be a value of 1 (the normal pull of gravity). However, in tight turns the amount of g experienced by the pilot and plane will increase (plus value) /decrease (minus value) dramatically and be shown on this HUD display.

Three sets of figures at the bottom right of the NAV HUD indicate:

Waypoint/Target number

Distance to Waypoint/Target (in miles)

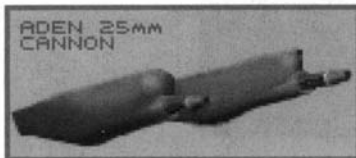
ETA to Waypoint/Target (in seconds)

By pressing Key W you can select a waypoint/target. The Shift/Backspace key will acquire that waypoint/target and you will see details of it in the TrackCam on the Multi Function Display.

Air/Ground Attack HUD Modes

To engage in air combat/ground attack, you must switch your HUD to attack mode by pressing the TAB Key. The A/G mode indicator will light up. You will then be able to access all targeting HUD functions by pressing the Return Key (cycle through).

Cannons



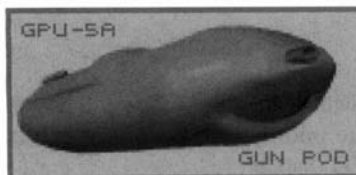
2x 25mm ADEN cannon (RAF)



25mm ADEN Pod (RAF)

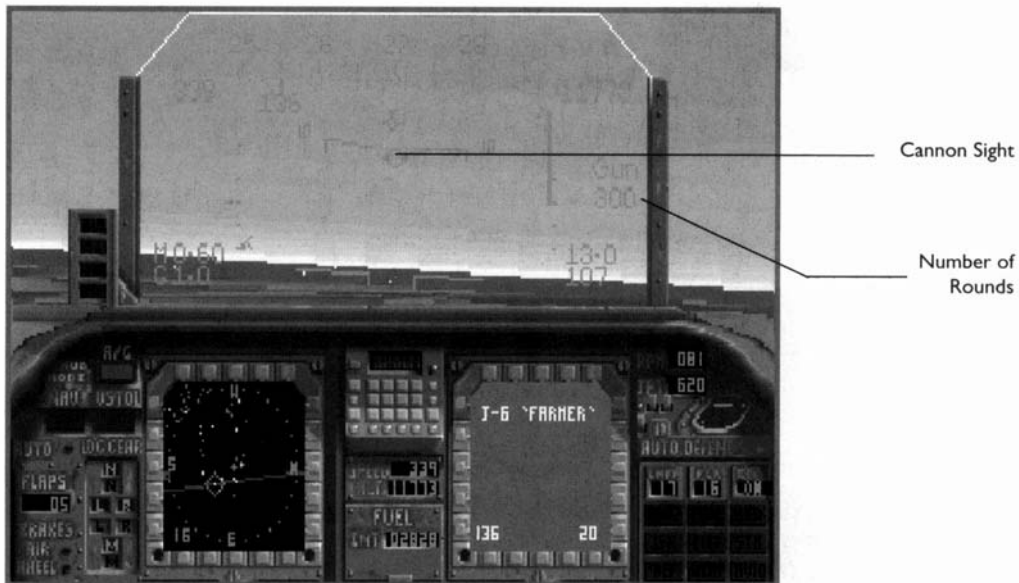


1x 25mm GAU-12U Equaliser cannon (USMC)



30mm GPU-5A pod (USMC)

HARRIER JUMP JET



The Cannon HUD

By selecting one of the above weapons you will have this HUD mode superimposed on your Harrier screen.

Aiming

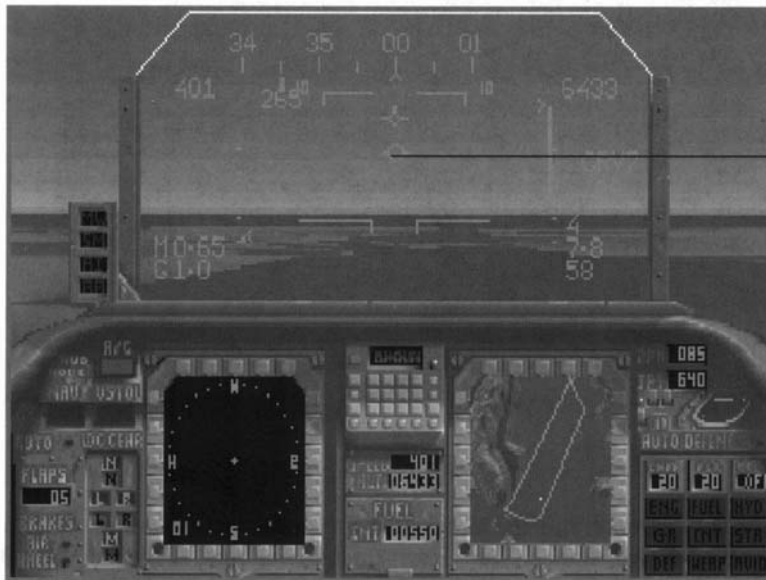
Aim at your target through the centre of the circle sight. If your target is stationary then try and get it in your sights from a good working distance. Slow down the Harrier (use Airbrakes Key B) and 'walk' the cannon shells towards it. If your target is moving, you must estimate its movement and fire where you think it will be by the time the shells have travelled the necessary distance through the air.

Fire with your *selector* (Space Bar or Joystick fire button). The number of cannon shells you have on board is limited and will reduce on a digital display as you fire.

Rockets



CRV-7 (Canadian Rocket Vehicle-7)



The Rockets HUD

Aiming

Aim at your target through the centre of the circle sight. If your target is stationary then try and get it in your sights from the correct distance (within 4 miles), slow down the Harrier (use Airbrakes Key B).

Fire with your *selector*.

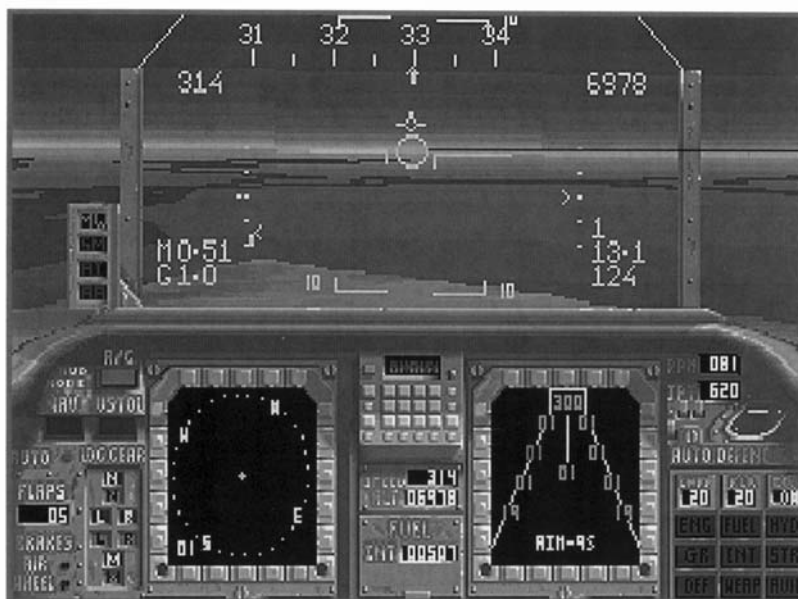
Rockets can also be fired in salvos (see end of section).

HARRIER JUMP JET

Air-to-Air Guided Missile



AIM-9S Sidewinder

Circle Sight in
'Caged' Mode*The Air-to-Air Missile Hud***Targeting**

The air-to-air missile is specifically for air combat. Sidewinders have an infra-red tracking device that will not 'lock-on' until you are relatively close to the target. If your infra-red emitting head loses sight of the target then you will lose 'lock'. Try to keep the 'locked' target in your forward field of vision.

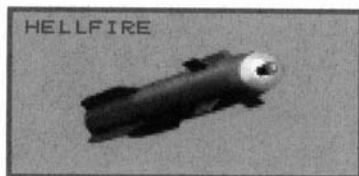
Aiming

An aiming circle will appear on your HUD in either 'caged' (centred) or 'uncaged' (rotating) format. There is no 'correct' mode and you can change from one style to another by pressing Key M.

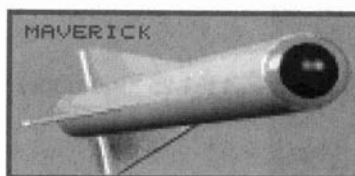
Point your aircraft towards the target. When the circle is over the target and the target is within range, the missile will lock-on. This will happen whether the circle is 'caged' or 'uncaged'.

Press your *selector*.

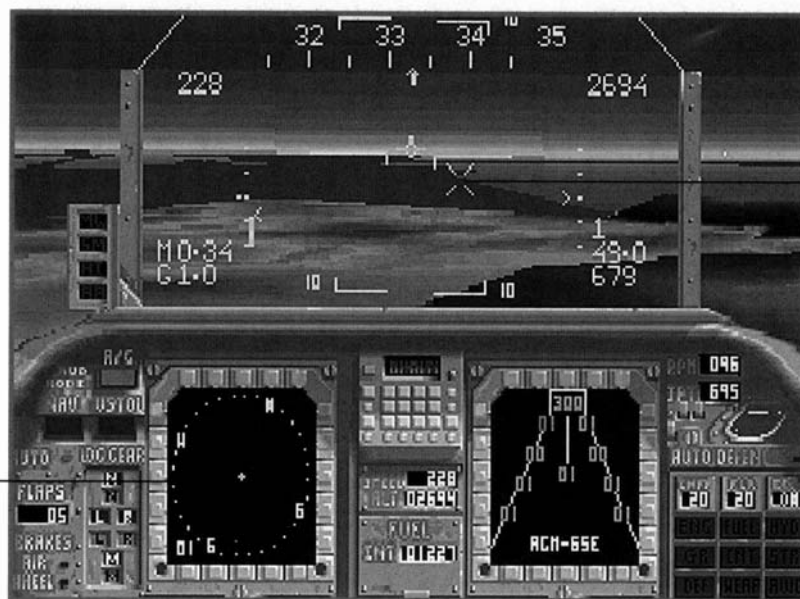
Air-to-Ground Laser-Guided Missiles



AGM-114B
Hellfire



AGM-65E
Maverick



X-Shape
Laser
Designator
Seeker Head

Tactical
Compass
Display

Targeting

There are three possible air-to-ground laser-guided missile aiming modes (Key M cycle through).

Narrow: an X shape moves left /right the length of the HUD pitch lines.

Wide: an X shape left/right the length of the complete HUD screen.

Figure-of Eight: an X shape moves in across the HUD in an angular figure-of-eight.

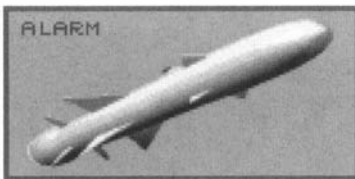
HARRIER JUMP JET

Aiming

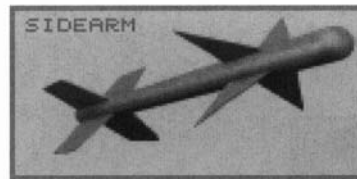
In moderate and realistic weapons mode, fly along the course bar on the tactical compass display. This bar shows the laser beam aimed towards a small square box.

Press Shift/Backspace to designate the target. The X locks-on the target. Fire when you are ready.

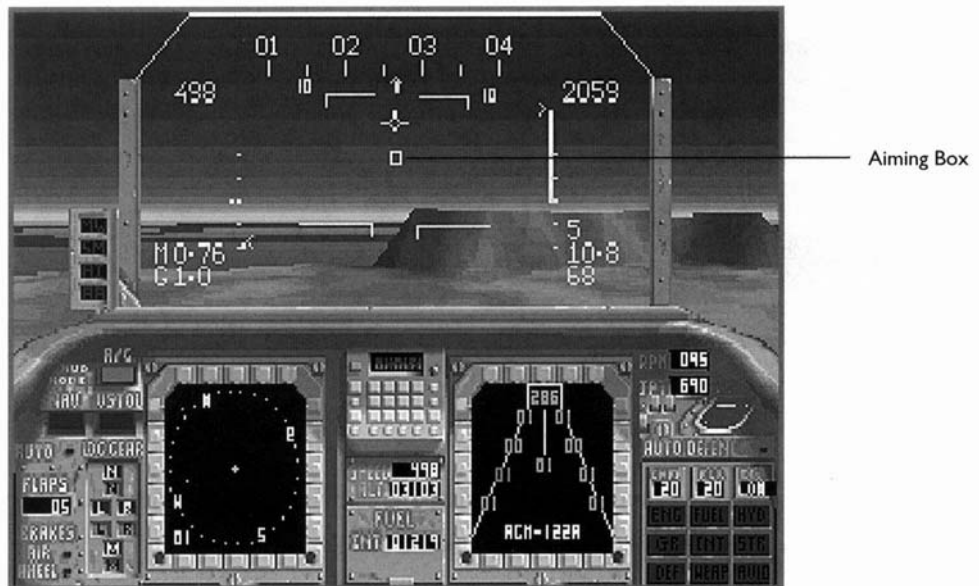
Air-to-Ground Radar-Guided Missiles



ALARM



**AGM-122
Sidarm**



Radar guided missile HUD

Targeting

A small square aiming box will appear on the HUD when you have chosen air-to-ground radar-guided missiles.

Point the square at the ground where you think the target is. Press Backspace and, if there is a radar site visible, the missile will lock-on automatically. Fire when in range.

The radar signal can be picked up from a long distance away, so be careful not to fire until you are within range for your chosen missile.

Laser-Guided Bombs



GBU-12 Paveway II



Mk 13 Paveway LGB



GBU-16 Paveway II

Delivery Height over 500 ft

Targeting

There are three possible laser-guided bomb aiming modes accessed by pressing Key M (cycle through).

Narrow: an X shape moves left /right the length of the HUD pitch lines.

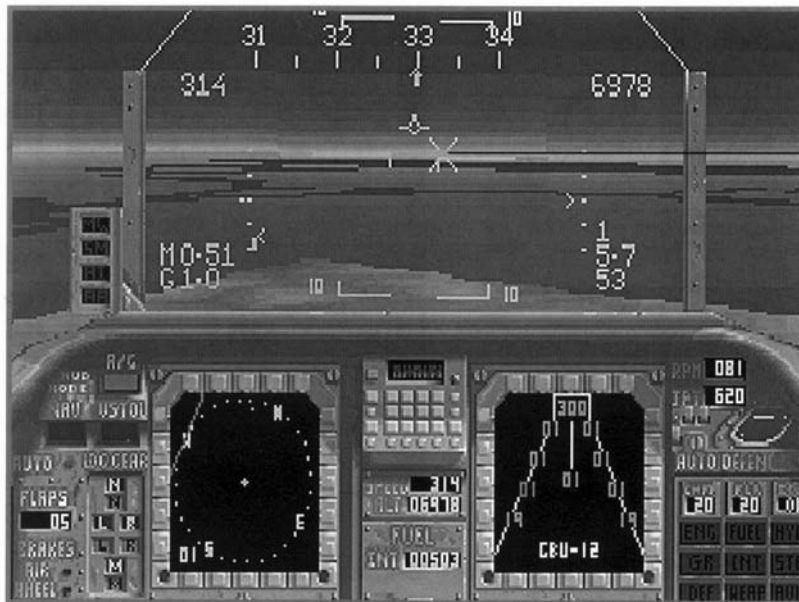
Wide: an X shape left/right the length of the complete HUD screen.

Figure-of Eight: an X shape moves in across the HUD in an angular figure-of-eight.

HARRIER JUMP JET

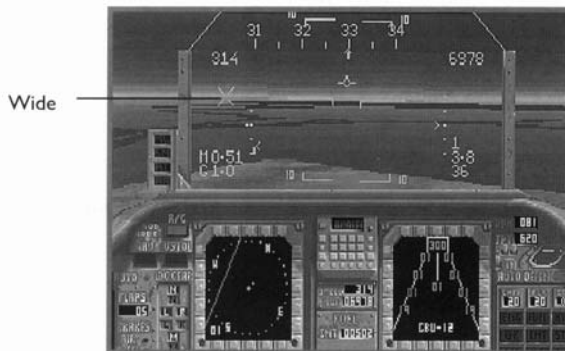
Aiming

In moderate and realistic weapons mode, fly along the course bar on the tactical compass display. This bar shows the laser beam aimed towards a small square box. Press Shift/Backspace to designate the target. The X locks-on the target. Fire when you are ready.



Narrow

The 3 laser designator seeker HUD modes

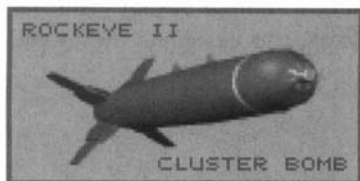


Wide

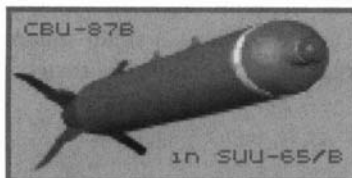


Figure of Eight

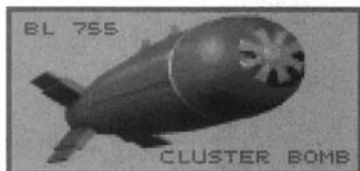
Retarded, Cluster, Anti-Runway and Free-fall Bombs



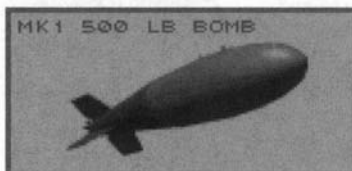
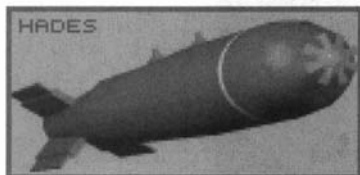
Rockeye II



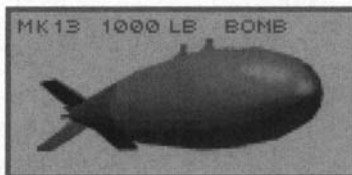
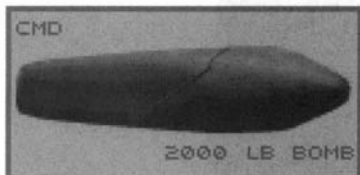
CBU-87B



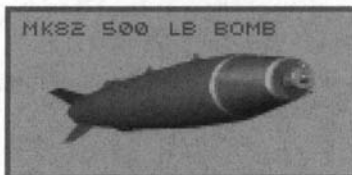
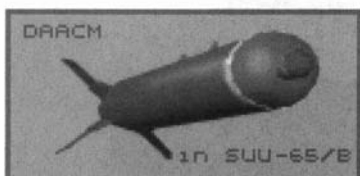
BL 755

Mk 1 500 lb GP
(and retarded)
HE bomb

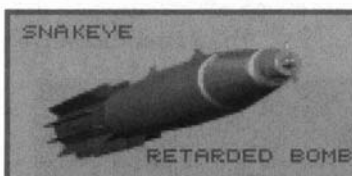
HADES

Mk 13 1000lb GP
(and retarded)
HE bomb

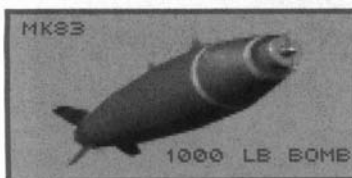
CMD-18

Mk 82 500lb GP
HE bomb

DAACM

Mk 82 Snakeye
retarded 500lb GP
bomb

CBU-55/B

Mk 83 1000lb GP
HE bomb

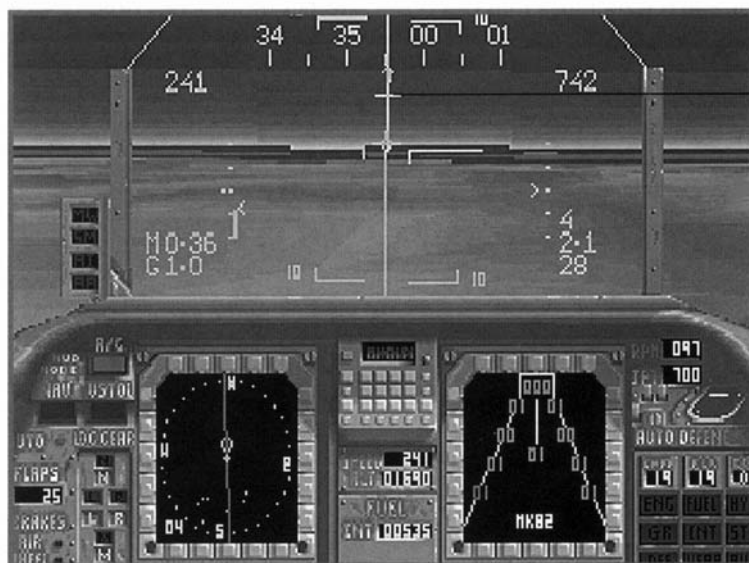
HARRIER JUMP JET

There are two aiming modes for these bombs : auto and manual (CCIP) mode accessed by pressing Key M (cycle through).



Manual Bombing

Continuously
Computed Impact
Point



Auto Bombing

Horizontal
Marker

Aiming

In manual mode (Continuously Computed Impact Point) a line extends from the central point FPI and ends in a cross showing where the bombs will strike if released at that particular moment. You must manoeuvre the Harrier so that the cross passes over the target then release with your *selector*. The bombsight will take account of the type of bomb (free-fall or retarded) and adjust the sight line accordingly.

In auto-bombing mode the HUD will change to a long line that passes from the top to the bottom of the screen lined up with the INS waypoint/target indicator. Fly towards the target heading, stay on course and hold down your *selector*. A small horizontal line will drop towards the central Flight Path Indicator. When the Harrier has reached the correct bombing point the bombs will be automatically released.

Firing Weapons in Salvoes

Harrier Jump Jet allows you to fire appropriate weapons (bombs and rockets) in salvoes. Details are shown in the weapons MFD display:

Keyboard 1 releases one weapon

Keyboard 2 releases two weapons

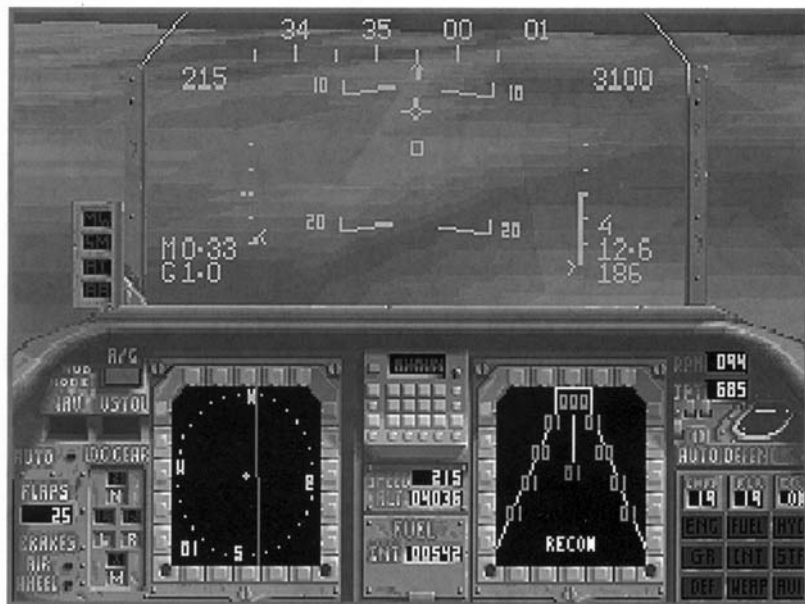
Keyboard 3 releases four weapons

Keyboard 4 releases all available weapons of that type.

When firing rockets in salvo remember that this is the number of weapons fired from each rocket pod.

HARRIER JUMP JET

Reconnaissance Camera

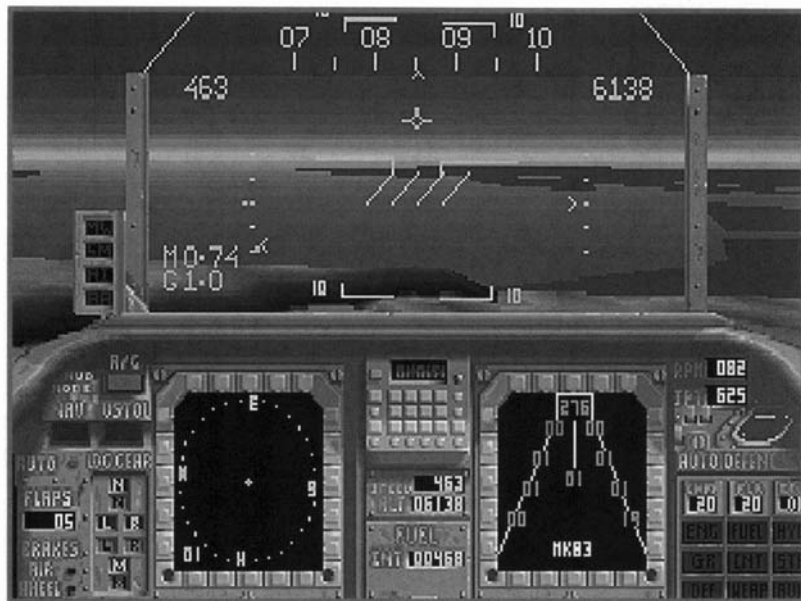


The Recon HUD

Aiming

Fly at an appropriate height from 500 to 2000 ft so that the square symbol in the the HUD passes through the centre of the target, then take the picture with your *selector*. You will receive a message across the top of your screen to tell you if a photograph has been taken successfully.

Stores Empty HUD



The Stores Empty HUD

This HUD pattern will appear when you have exhausted a particular weapons pylon. Press the Return Key to select other weapons on the Harrier. The HUD will change automatically to suit the selected ordnance.

Night Vision Goggles/ FLIR (Key N on/off)

The Harrier has excellent night attack capabilities and the simulation will include night missions when you will be able to use the FLIR (Forward Looking Infra Red) to spot targets and other aircraft. All the above HUD modes will still apply. Night Vision Goggles/FLIR can be turned on/off using Key N.

HARRIER JUMP JET**Weapons Control Summary**

| | |
|------------------------|---------------------------------------------------------------------|
| Backspace | Target Acquire |
| Shift/Backspace | Designate current waypoint as target |
| ALT/L | Break Lock |
| Key M | Attack/Target Mode select (depends on current selected weapon type) |
| Space Bar | Fire/Release selected weapon(s) |
| Return | Weapons Type Select (cycle through weapons) |
| Keyboard 1 | Release 1 selected weapon in salvo |
| Keyboard 2 | Release 2 selected weapons in salvo |
| Keyboard 3 | Release 3 selected weapons in salvo |
| Keyboard 4 | Release all selected weapons in salvo |
| Key N | Night Vision Goggles/FLIR on/off |

Harrier Weapons Summary

| Weapon | User | Max Range | Max Speed | Guidance System | Attack Altitude | Attack Technique |
|--------------------------------------------------------------------------------------------------------------------------------------------|-----------------------------|--------------------------------------|----------------------------------------------|---------------------------------------------------------------|--------------------------------------|----------------------------------------------------------------------------------------------------------------------------------|
| Cannons 25mm ADEN cannons GAU-12 Equalizer 25mm ADEN pod GPU-5A pod | RAF USMC RAF USMC | 1500 m 1500 m 1500 m 1500 m | 1050 m/s 1097 m/s 1050 m/s 1037 m/s | gunsight gunsight gunsight gunsight | 0 m+ 0 m+ 0 m+ 0 m+ | anticipation firing anticipation firing anticipation firing anticipation firing |
| Rockets CRV-7 Rocket Pack | Both | 6.5 km | 4500 km/h | none | 0 m+ | anticipation firing |
| Air-to-Air Missiles AIM-9S Sidewinder | Both | 8 km | Mach 2.5 | IR homing | 150 m+ | air-to-air fire and forget |
| Air-to-Ground Guided Missiles ALARM AGM-122A Sidarm AGM-114B Hellfire AGM-65E Maverick | RAF USMC USMC Both | 45 km 8 km 8 km 20 km | Mach 3+ Mach 2.3 Mach 0.9 Mach 1 | Radar homing Radar homing Laser homing Thermal Image | 150 m+ 150 m+ 50 m+ 150 m+ | air-to-ground fire and forget air-to-ground fire and forget air-to-ground fire and forget air-to-ground fire and forget |
| Free-fall Bombs Mk1 500lb HE bomb Mk13 1000lb HE bomb Mk82-0 500lb GP slick bomb Mk83 1000lb GP slick bomb | RAF RAF USMC USMC | 0 km 0 km 0 km 0 km | freefall freefall freefall freefall | none none none none | 300 m+ 300 m+ 300 m+ 300 m+ | level or dive bombing level or dive bombing level or dive bombing level or dive bombing |
| Retarded Bombs Mk1/118 Retarded 500lb HE bomb Mk13/117 Retarded 1000lb HE bomb Mk82-1 500lb Snakeye retarded bomb | RAF RAF USMC | 0 km 0 km 0 km | retarded retarded retarded | none none none | 150 m+ 150 m+ 150 m+ | level bombing level bombing level bombing |
| Laser-guided Bombs Mk13 Paveway LGB GBU-12 Paveway II 500lb LGB GBU-16 Paveway II 1000lb LGB | RAF USMC USMC | 1+ km 1+ km 1+ km | glides glides glides | Laser homing Laser homing Laser homing | 300 m+ 300 m+ 300 m+ | toss or level bombing toss or level bombing toss or level bombing |
| Cluster Bombs & Weapons Dispensers BL 755 cluster bomb HADES Rockeye II cluster bomb SUU-65B + CBU-87B | RAF RAF USMC USMC | 0 km 0 km 0 km 0 km | freefall freefall freefall freefall | none none none none | 76 m 300 m+ 76 m 76 m | level bombing level bombing level bombing level bombing |
| Fuel-Air Munitions CBU-55B FAE bomb | USMC | 0 km | freefall | none | 300 m+ | level bombing |
| Anti-Runway Weapons CMD18 2000lb anti-runway weapon SUU-65B + DAACM | RAF USMC | 0 km 0 km | freefall freefall | none none | 300 m+ 300 m+ | level bombing level bombing |

HARRIER JUMP JET

Key to Harrier Weapons Summary

Weapon: the name of the weapon system.

Max Range: The maximum range at which the weapon can be fired or launched against a target. Note that this is not necessarily the same as the effective range for a weapon, which is often much shorter.

A 0 km range means the weapon is a free-fall or retarded bomb which must be released over the target.

Max Speed: The speed of the weapon as it reaches the target. In the case of the cannons the number given here is the muzzle velocity.

Glides means that the weapon ‘flies’ without power to the target, therefore your speed when the weapon is released is the weapon’s speed.

Free fall weapons are traditional bombs that arc down towards the ground (and hopefully the target) once released. They have the same initial forward speed as your aircraft, so if they are dropped when you are low there is a danger that they will explode directly beneath your aircraft and cause considerable damage to you as well as the target!

Retarded means that the weapon is a retarded bomb. These are the same bomb as the freefall type of the same weight, but fitted with a special tail that slows the bomb down in flight. The tail either pops open in a flat-faced cruciform shape, releases a small parachute, or inflates a ballute (Russian for ‘balloon’) to slow the bomb and stabilise its fall.

Guidance System: If the weapon has a special on-board guidance system it is mentioned here. The guidance system also has an effect on how and when the weapon may be released against a target — a guided weapon has to ‘see’ its target!

Attack Altitude: This is the recommended altitude for a typical attack with the weapon. A notation of ‘75 m+’ means that any height above 75 m is acceptable. You can, of course, use weapons at below the recommended altitude, but don’t be surprised if they fail to work properly: bombs, for example, need to fall for a certain distance before they arm themselves.

Attack Techniques: This is a reference to the appropriate attack method. Where alternative techniques are given, you will need to make a tactical choice as to which you prefer and which is safer. Toss bombing means climbing while dropping the weapon, and gaining height in a combat zone may well expose you to a greater volume of enemy fire.

Harrier Weapon Effectiveness Against Common Targets

| Weapon | A/F | HG | RY | A/G | TR | HY | BR | BG | BK | DP | MS | RD | PL | SP | HVs | LVs | SS |
|---------------------------------------------------|-----|----|----|-----|----|----|----|----|----|----|----|----|----|----|-----|-----|----|
| Cannons | | | | | | | | | | | | | | | | | |
| 25mm ADEN cannons | B | F | F | B | B | F | F | B | F | B | B | C | B | C | F | D | B |
| GAU-12 Equalizer | B | F | F | B | B | F | F | B | F | B | B | C | B | C | F | D | B |
| 25mm ADEN pod | B | F | F | B | B | F | F | B | F | B | B | C | B | C | F | D | C |
| GPU-5A pod | B | F | F | B | B | F | F | B | F | B | B | C | B | C | F | D | C |
| Rockets | | | | | | | | | | | | | | | | | |
| CRV-7 Rocket Pack | C | F | F | D | D | F | F | C | C | D | D | D | D | C | C | C | B+ |
| Air-to-Air Missiles | | | | | | | | | | | | | | | | | |
| AIM-9S Sidewinder | A | F | F | F | F | F | F | F | F | F | F | F | F | F | F | F | F |
| Air-to-Ground Guided Missiles | | | | | | | | | | | | | | | | | |
| ALARM | F | F | F | F | F | F | F | F | F | F | F | A+ | F | F | F | F | F |
| AGM-122A Sidarm | F | F | F | F | F | F | F | F | F | F | F | A | F | F | F | F | F |
| AGM-114B Hellfire | F | D | F | C- | D | F | F | D | B | C- | C- | C- | B | D | A- | A | D |
| AGM-65E Maverick | F | C- | D | C | C | B | B | C | B+ | C | C | B | B | B | B | B+ | C |
| Free-fall Bombs | | | | | | | | | | | | | | | | | |
| Mk1 500lb HE bomb | F | C | D | C | B | D | D | B | D | B | C | C- | B | C | D | D | C |
| Mk13 1000lb HE bomb | F | B+ | D | C | B+ | B+ | B+ | A | B | B+ | C | C | B+ | B | C | C | C |
| Mk82-0 500lb GP slick bomb | F | C | D | C | B | D | D | B | D | B | C | C- | B | C | D | D | C |
| Mk83 1000lb GP slick bomb | F | B+ | D | C | B+ | B+ | B+ | A | B | B+ | C | C | B+ | B | C | C | C |
| Retarded Bombs | | | | | | | | | | | | | | | | | |
| Mk1/118 Retarded 500lb HE bomb | F | F | D | B | B | F | F | B+ | F | B | F | C- | B | F | C- | C- | B |
| Mk13/117 Retarded 1000lb HE bomb | F | F | C | B+ | B+ | F | F | A+ | F | B+ | F | C | B+ | F | C | C | B+ |
| Mk82-1 500lb Snakeye retarded bomb | F | F | D | B | B | F | F | B+ | F | B | F | C- | B | F | C- | C- | B |
| Laser-guided Bombs | | | | | | | | | | | | | | | | | |
| Mk13 Paveway LGB | F | A | C | C | B+ | A- | A | A+ | A | A | A | A | A+ | B+ | A | A+ | A+ |
| GBU-12 Paveway II 500lb LGB | F | A- | D | C- | B | B | B+ | B+ | B+ | B+ | B+ | B+ | B+ | C | B+ | B+ | A+ |
| GBU-16 Paveway II 1000lb LGB | F | A | C | C | B+ | A- | A | A+ | A | A | A | A | A+ | B+ | B+ | B+ | A+ |
| Cluster Bombs & Weapons Dispensers | | | | | | | | | | | | | | | | | |
| BL 755 cluster bomb | F | F | F | B+ | C | F | F | B+ | D | B+ | B+ | B+ | A | C- | B+ | A+ | A+ |
| Rockeye II cluster bomb | F | F | F | B | B | F | F | B | F | B | B+ | B | B | C- | C | C | C |
| HADES | F | F | B+ | B+ | B | F | F | B | D | B | C | C- | C | F | D | D | D |
| SUU-65B + CBU-87B | F | F | F | B+ | C- | F | F | B | D | B+ | B+ | B+ | A | C- | B | A | A+ |
| Fuel-Air Munitions | | | | | | | | | | | | | | | | | |
| CBU-55B FAE bomb | F | D | F | C | D | D | F | B+ | B+ | B+ | B+ | C | A+ | B | B | B+ | B+ |
| Anti-Runway Weapons | | | | | | | | | | | | | | | | | |
| CMD18 2000lb anti-runway weapon | F | F | A+ | F | F | D | C | F | D | F | F | F | F | F | F | F | F |
| SUU-65B + DAACM | F | D | A | C | B | F | F | B | F | B | C | C- | C | F | D | D | D |

HARRIER JUMP JET

Key to Weapons Effectiveness Against Common Targets

Target Type Abbreviations

| | |
|------------|-----------------------------------------------------------------------------------------------------------------------------------------------------------------------------------------------------------------------------------------------------------|
| A/F | Aircraft in flight. |
| HG | Airbase hangar; at military airfields these are usually armoured concrete bunkers. |
| RY | concrete airfield runway, as opposed to temporary air strip dirt runway. |
| A/G | aircraft parked on a runway or dispersed on the apron (ie not inside protected hangars). |
| TR | Airfield tower, including the air traffic control, radar and radio facilities. |
| HY | A general category for large civilian-built facilities, such as factories, power plants, dams, etc. |
| BR | Road or railroad bridges over rivers. |
| BG | A catch-all category for civilian-style buildings, including terrorist camps, offices, warehouses, villages, houses and the like. |
| BK | Fixed army HQs and fortifications. |
| DP | Large, logistically significant stockpiles of military equipment, fuel and ammunition. |
| MS | Any kind of large missile launcher, including both fixed sites and mobile launchers. For example, both SAMs and ballistic missiles (such as Scuds) fall into this category. |
| RD | Any type of radar equipment, fixed or mobile, from mobile SAM radar trucks to fixed phased-array sites and Over-the-Horizon long-range radars. |
| PL | Petrol, Oil, Lubricants, and any site or vehicle connected with them from tanker trucks to oil tanks, refineries and platforms. |
| SP | All types of ships from frigates, destroyers and surfaced submarines to merchant marine bulk carriers and oil tankers. Modern weapons are so destructive as to make distinctions between lightly-armoured military vessels and civilian ships irrelevant. |
| HVs | Main Battle Tanks and derivatives such as armoured recovery vehicles. |
| LVs | Infantry Fighting Vehicles such as the Warrior or Bradley, smaller tanks and self-propelled artillery. |
| SS | Unarmoured vehicles, trucks, jeeps, 'Hummers' (HMMWVs) towed artillery and dug-in infantry positions. |

Results Abbreviations

The effectiveness of each weapon against each target category is graded like a report card. The better the grade, the more effective the weapon. As will be seen by studying the table, certain weapons are highly specialised and optimised for use against very specific types of target.

A+, A, A- graded weapons are especially effective against the target type, and have usually been designed to destroy exactly that type of targets. These are the weapons you can rely on to 'do the job' every time, providing you release them correctly.

B+, B, B- grades mean that the weapons are of acceptable accuracy and effectiveness against this type of target. Using one of these, you can generally expect to destroy your target.

C+, C, C- grades mean that the weapon can damage the target, but your attack needs to be very accurate. Don't, for example, rely on C graded weapons to destroy a mission-winning target.

D grades indicates that the weapon is marginally effective, but cannot be relied upon to do the job. It will destroy the target if you are very skillful or very lucky — or better yet, both!

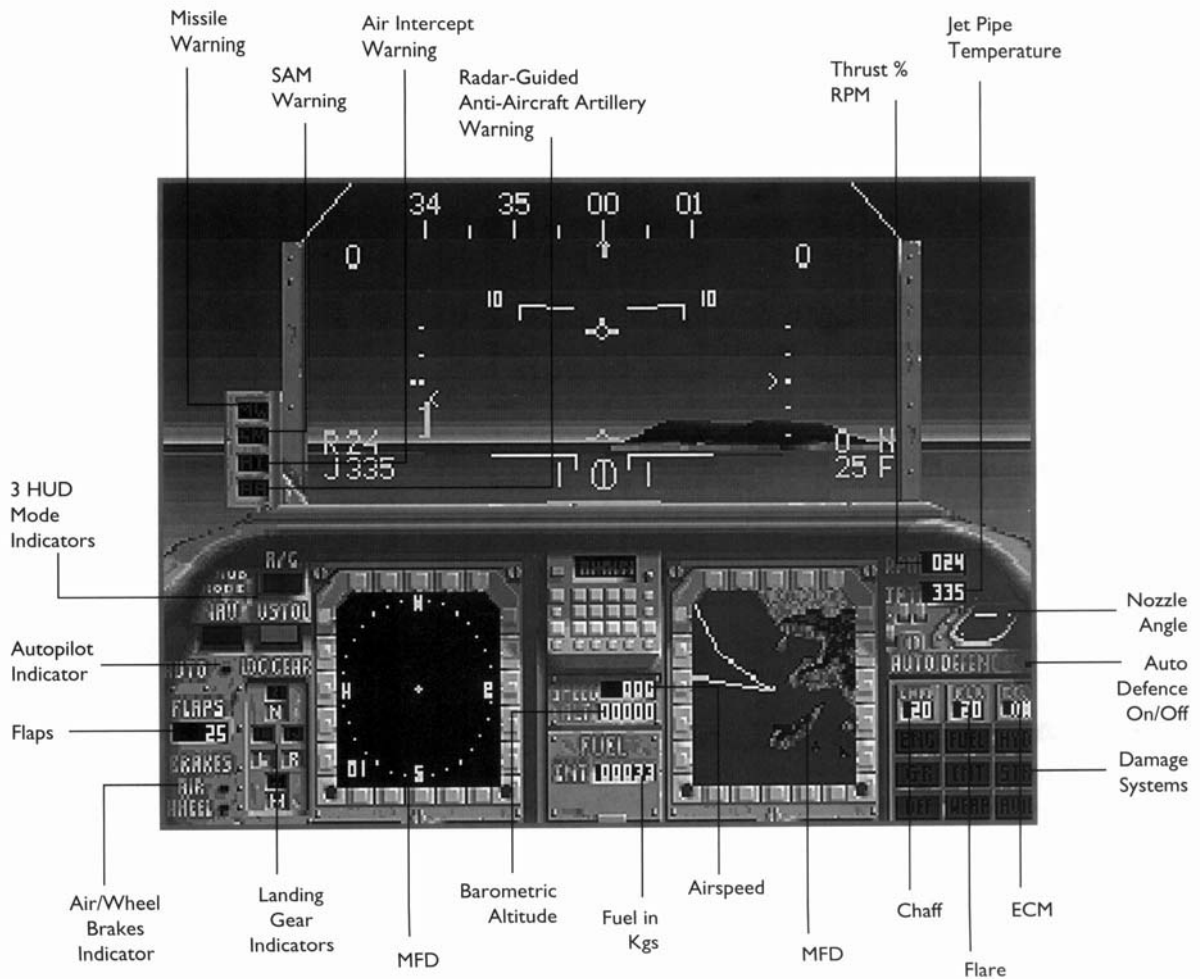
F against a weapon means that it is virtually useless against that type of target. Any attacks under these circumstances are a waste of time and valuable ammunition.



**THE
COCKPIT
DISPLAYS**

HARRIER JUMP JET

THE COCKPIT DISPLAYS



Autopilot (Key A on/off)

Press Key A to set Autopilot to take you towards waypoint/target. The Auto button will light up in the cockpit. Press again to deselect.

Landing Gear (Key G up/down)

The Landing Gear Indicator shows the state of all four landing gear on the Harrier: Nose (N), Left (L), Right (R), and Main (M). Remember that gear motors will begin to function when you press the key and may take a short time before completing the task.

Flap angle

The amount of Flap Extension is shown on a digital scale. Flap extension is important for all take-off and landing functions but will auto-engage when nozzles and landing gear are raised or lowered.

HUD Mode (TAB Key)

Cycle through the appropriate HUD modes:

V/STOL

Vertical, Short Take-Off and Landing HUD. This HUD Mode should be implemented when performing any of these manoeuvres.

NAV

This HUD Mode should be used to perform all Navigation functions waypoint/target seeking.

A/G

This HUD Mode should be implemented in order to deploy all ordnance, perform offensive, defensive and reconnaissance objectives. (See section on HUD Modes).

Brakes Air/Wheel (Key B on/off)

Key B will turn on Air OR Wheel Brakes depending on whether the Harrier is in the air or on the ground. Press again to deselect.

Airspeed

A digital read-out of speed through the air in knots.

Altitude

A digital read-out of barometric (above sea level) altitude. Be aware that this will vary from HUD altitude information.

Fuel

The amount of fuel remaining is shown in kgs.

HARRIER JUMP JET

Thrust %RPM

Indicates the amount of thrust from the Pegasus engine as a percentage.

JPT

Jet Pipe Temperature. The temperature of the jet nozzles. Engine damage may result from overheating the engine. Keep an eye on this dial (repeated on the HUD). Remember to reduce thrust to a workable rate (80-85%) to prevent overheating.

Nozzle Angle (Open/Close Square Brackets [or])

A dial showing the Nozzle Angle of the four jet nozzles on your Harrier from 0° to 98°. In addition Shift/ [sets nozzles at 98° and Shift] sets them to 0°.

Nozzle Keys [(down) &] (up).

Tapping nozzle Key [once gives you a take-off angle of 55° on the ground. In the air this increases nozzle angle in 1° increments to 98° max.

Key] decreases nozzle angle by 1° decrements.

Damage Systems Indicator

These indicators will light up if your Harrier has sustained damage.

ENG-Engine

FUEL-Fuel System

HYD-Hydraulic Systems

GR-Landing Gear

CNT-Control Systems

STR-Structural Damage

DEF-Auto-Defense Capabilities

WEAP-Weapons Systems

AVIO-Avionics (HUD, INS, TrackCam, Moving Map Display)

Auto Defence (Key D) On/Off

The Auto Defence system will auto-fire Chaff/Flare when the need arises.

Chaff (Key C)

Chaff remaining indicator. Each time you release a chaff cartridge against radar guided missiles, the indicator will reduce by 1. There are a maximum of 20 cartridges carried on the Harrier.

Flares (Key F)

Flares remaining indicator. Each time you release a flare cartridge against infra red guided missiles, the indicator will reduce by 1. There are a maximum of 20 cartridges carried on the Harrier.

ECM (Key E on/off)

The Harrier has full Electronic Counter Measures (ECM) capabilities to confuse enemy missiles and decrease the effectiveness of short range radar and SAMs.

This applies all the time to the RAF Zeus System on the GR 7 but only to the AV-8B when the AL/ALQ-164 ECM pod is fitted.

Cockpit Warning Lights

To the left of the HUD screen there are four warning lights:

MW-Missile warning (any missile IR/Radar-guided).

A missile is locked-on to your aircraft and is heading towards you. If you examine the Tactical Compass you will see a missile heading towards you.

SM-Surface-to-Air Missile warning. A SAM radar tracking device has picked up your aircraft.

AI-Air Intercept. Enemy aircraft radar is tracking your Harrier.

AA- Radar guided anti-aircraft artillery is tracking your Harrier.

The Multi-Function Displays

(Left-hand Key Z / Right-hand Key X cycle-through)

The left and right Multi-Function Displays (MFDs) show a selection of important information.

Ordnance/Equipment Display (Keys Z/X)

A diagrammatic representation of weapons/offensive/defensive systems and any other special equipment carried by the Harrier. This display shows, either a default load accepted by the pilot during the arming procedure, or a custom selected load chosen by the pilot. The diagram shows the currently selected weapon highlighted.

To change the selected weapon press Return.

HARRIER JUMP JET

Mission Briefing Reminder (Key 9 /right MFD)

This display shows a summary of the current mission details including (if applicable):

Mission Type
Primary Target
Secondary Target
Landing Point

Tactical Compass (Keys Z or X)

A top-down radar display showing the points of the compass with your Harrier at the centre.

Aircraft movement is always towards the top of the display and points of the compass rotate as direction is changed.

A Line crossing the Tactical Compass - shows the laser designated path to the current waypoint/target.

A Circle - A Waypoint
A Diamond - A Designated Target
White Dots - Aircraft
Green Dots - Ground Objects
Red Dots - Missiles

The Tactical Compass can be scaled up x1,x2 x4, x8, x16 by pressing Key S or Key 6 or scaled down by pressing Shift/S or Shift/6.

Moving Map Display (Keys Z or X)

An accurate 2D map of the selected area of conflict indicating the position of your aircraft and its flight path.

Waypoints can be turned on and off from the Moving Map Display by pressing Key 7.

Tracking Camera View (Keys Z or X)

Shows zoom camera view of a designated target with heading (on the left) and distance in miles (on the right).



**CAMERA
AND VIEW
CONTROLS**

HARRIER JUMP JET

CAMERA AND VIEW CONTROLS

Cockpit Views

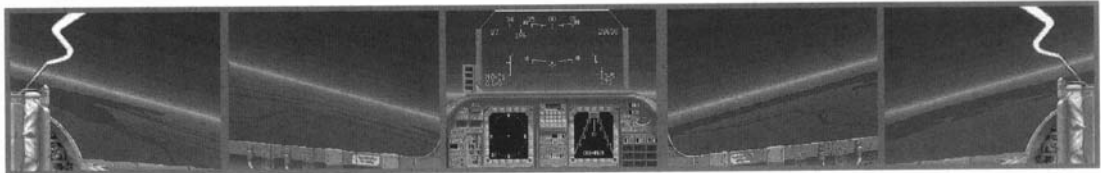
F1

F2

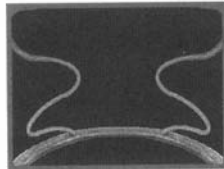
F3

F4

F5



F6



Function Key

| | |
|----|------------------------------------------------|
| F1 | Left back (over the shoulder) in-cockpit view |
| F2 | Left side in-cockpit view |
| F3 | Forward in-cockpit view |
| F4 | Right side in-cockpit view |
| F5 | Right back (over the shoulder) in-cockpit view |
| F6 | Up (head back) in-cockpit view |

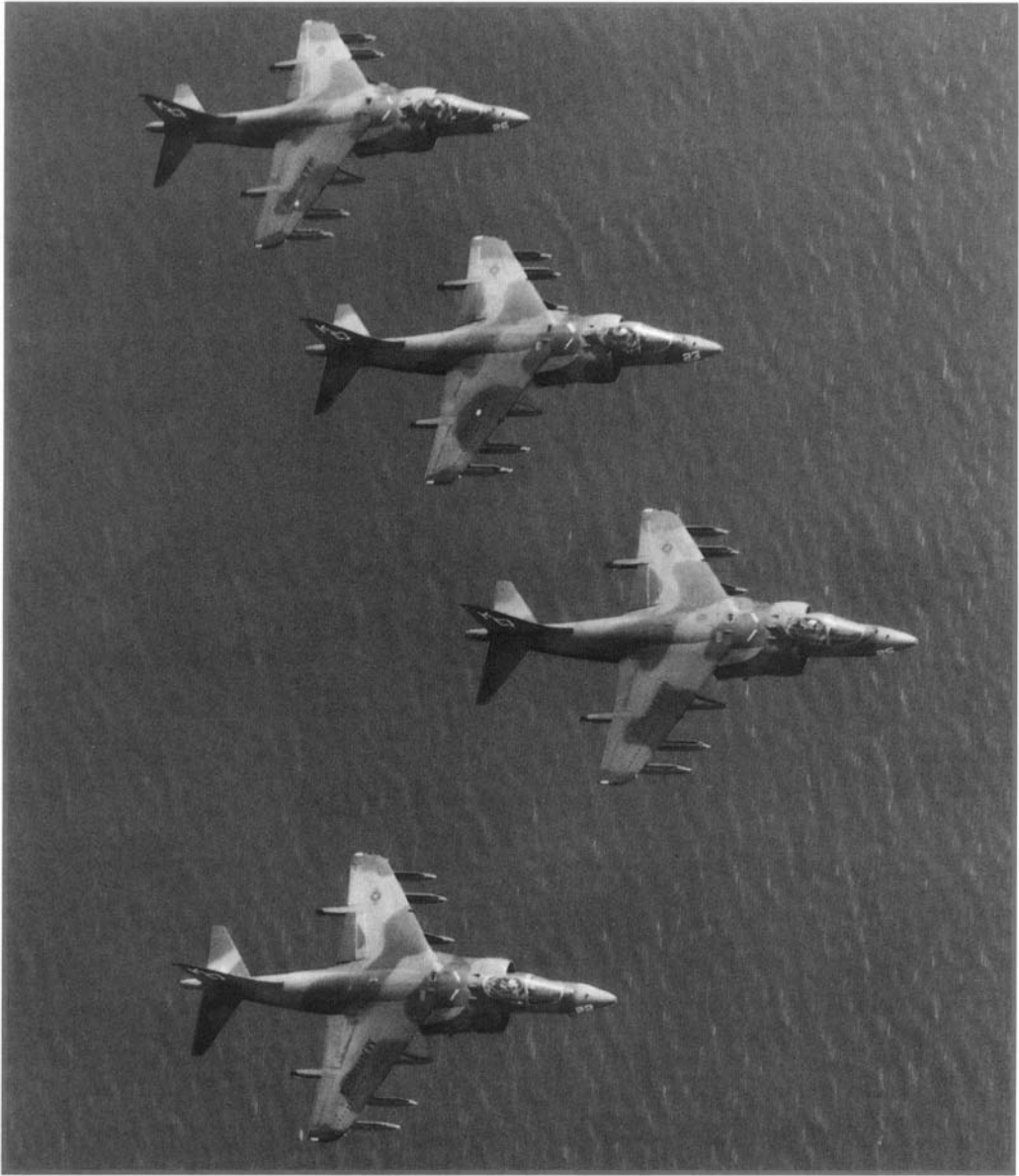
Tactical Views

| | |
|----------|-----------------------------------------------------------------------------------------------------------------------------------------------------------------------------------------------------------------------------------------------------------------------------------|
| F7 | Tactical Camera View You are positioned behind the Harrier looking past it at the target being tracked on the aircraft's HUD. This view rotates and pans to keep the Harrier and its target in view. |
| Shift F7 | Inverse Tactical Camera View You are positioned behind the Harrier's target looking past it at the Harrier which may only be a dot in the distance. The target may be another plane or a ground target. This view rotates and pans to keep the Harrier and its target in view. |
| F8 | 'Free-flying' Camera View Select 'Free-flying Camera (see below) |

Free-Flying Camera Views

| | |
|---------------|--------------------------------------------------------------------|
| Numeric / | 'Free-flying' camera view: cycle 'up' through simulation objects |
| Numeric * | 'Free-flying' camera view: cycle 'down' through simulation objects |
| Numeric Pg Up | Rotate 'free-flying' camera up 'over' object |
| Numeric Pg Dn | Rotate 'free-flying' camera down 'under' object |
| Numeric Ins | Rotate 'free-flying' camera left round object |
| Numeric Del | Rotate 'free-flying' camera right round object |
| Numeric - | Zoom out (move 'free-flying' camera away from object) |
| Numeric + | Zoom in (move 'free-flying' camera towards object) |
| Key Pad Pg Up | Rotate 'free-flying' camera up 'over' object |
| Key Pad Pg Dn | Rotate 'free-flying' camera down 'under' object |
| Key Pad Ins | Rotate 'free-flying' camera left round object |
| Key Pad Del | Rotate 'free-flying' camera right round object |

HARRIER JUMP JET



A flight of US Marine Corps Harriers on coastal patrol



HARRIER JUMP JET

MISSION DEBRIEFING



At the end of a mission a Harrier is camouflaged in its hide

Day End Intelligence /Report Screens

A summary of your particular mission/day will be shown in the Debriefing Room including flight path, any use of ordnance and targets hit or destroyed.

Day Operations End

If you are engaged in a campaign you will receive intelligence of the effect your mission(s) have had on the general war campaign.

Medals and Promotions

Appropriate rewards will be awarded to you depending on the air force you have chosen to fly with.

Campaign End

Your campaign will end when, either you have helped to defeat the enemy, or your forces have been completely overrun by the enemy.

HARRIER JUMP JET



**HARRIER
WEAPONS
AND
DISPLAYS**

HARRIER JUMP JET

HARRIER WEAPONS AND SUPPLIES

Cannons

Most Effective against:

Aircraft in flight
 Aircraft on ground (not in hangar)
 Airfield tower, radio/radar
 Non-military buildings
 Stockpiles of military equipment
 Large missile launchers
 'Soft targets' trucks etc.



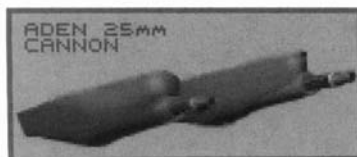
GAU-12/U Equalizer

The General Electric 'Equalizer' has a five-barrel Gatling type cannon with a pneumatic drive system in an under fuselage pod.

Firing rate 4,200 rounds per minute with a capacity of 300 rounds.

Weight: 559 kg

Drag Factor: 0.14



Aden 25 mm

Developed by Royal Ordnance the 25mm Aden has a slow rate of fire but can be fitted in two places under the fuselage. It is pneumatically cocked, gas operated, revolver cannon with a rate of fire of 1750 rounds per minute. The Aden has a low recoil factor and reaches maximum rate of fire very quickly.

Weight: 430 kg

Drag Factor: 0.12

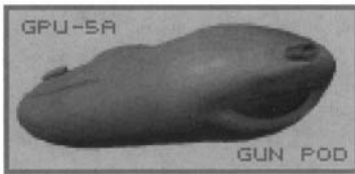


25 mm ADEN podded gun

Single-barrelled ADEN gun firing 31 rounds per second with a capacity of 330 rounds.

Weight: 798 kg

Drag Factor: 0.12



GPU-5A 30 mm Gun Pod

Four-barrelled Gatling type gun with a rate of fire of 50 rounds per second and ammunition capacity of 353 rounds.

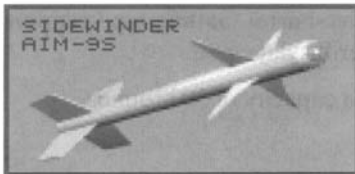
Weight: 862 kg

Drag Factor: 0.12

Air-to-Air Guided Missiles

Most effective against:

Aircraft in the air



AIM-9S Sidewinder

The AIM-9S is the best dogfighting missile currently available. It has the capability to hang on to twisting, turning targets. Combat pilots like to use it when catching enemy fighters from the rear, from above or nose on. The Sidewinder's main weakness is its short range.

Heat-Seeking Air-to-Air Missile

Impact Velocity: Mach 3.5 (2600 mph)

Range: 5 miles

Weight: 87 Kg

Speed: Mach 2+

Attack Altitude: 500 ft +

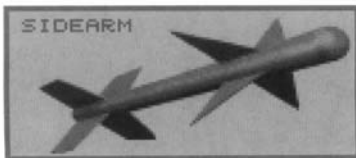
HARRIER JUMP JET

Seeker: All aspect infra-red
 Attack Technique: Air-to-air 'fire-and-forget'.
 Drag Factor: 0.01

It's very easy to get confused by the number and type of weapons carried by the Harrier. We don't expect you to learn the weapon types and their capabilities off by heart but bear in mind that you can try to hit any target with any weapon. Eventually, you will find out that some weapons are more effective than others. After that you may choose to study each weapon's capabilities in the manual and select the precise tool for the job.



Air-to-Ground Guided Missiles



AGM-122A Sidarm

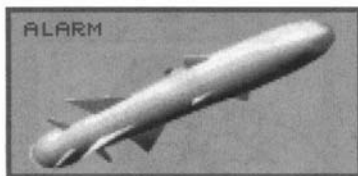
Most effective against:

Radar equipment fixed/mobile.

Impact Velocity: Mach 3 (990 m/s)

Drag Factor: 0.01

A low-cost, lightweight anti-radar missile with a broad band passive radar seeker. Weighing 91 kg it has a max firing range of 5 miles and is effective against SAM and gun control radar.



ALARM (Air Launched Anti-Radar Missile)

Most effective against:

Radar equipment fixed/mobile.

One of the world's most advanced anti-radar missiles. Like other weapons in its class, it can follow radar signals back to their source: an enemy radar set.

Before take-off the missile is programmed with a complete library of enemy radar signatures, each of which can be assigned a priority for attack. The pilot can then, for example, release individual ALARMs against specific enemy radar in the knowledge that each missile will only attack its own personal priority target. ALARM can be fired without implementing the launching aircraft RWR.

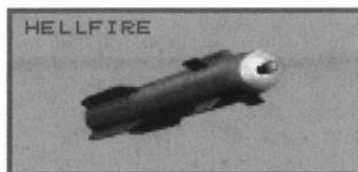
The missile can be launched in direct mode towards a hostile radar source. The missile can also be launched in indirect mode- it climbs to 40,000 feet, deploys a parachute and then waits until it detects a signal. It then performs an unpowered dive onto the target.

Impact Velocity: Mach 2.5 (1850 mph)

Range: 28 miles

Weight: 268 kg

Drag Factor: 0.02



AGM-114B Hellfire

Most effective against:

Fixed HQs and fortifications

Stockpiles

Large missile launchers

Aircraft on ground

Armoured Vehicles

Weight: 46 kg

Maximum Range: 5 miles/ 8 km

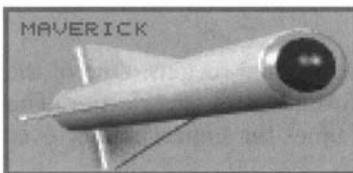
HARRIER JUMP JET

Impact Velocity: M 1.17 (870 mph/386 m/sec)

Drag Factor: 0.02

Guidance System: Semi-active laser/MMW Radar

An anti-armour weapon system. The 114A model requires the target to be illuminated by a laser source; however, it need not be the launching aircraft. The 114B model has a millimetre wave radar seeker and is a true fire-and-forget weapon system.



AGM-65 Maverick E

Most effective against:

Fixed HQs and fortifications

Factories, Power plants

Road/Rail Bridges

Radar equipment fixed/mobile

Armoured Vehicles

Length: 8ft 2ins

Weight: 293 kg

Range: 1/2 to 13 miles

Warhead: 125 lb shaped charge

Seeker: Laser

Attack Altitude: 500 ft +

Impact Velocity: M 1.5

Drag Factor: 0.05

Attack Technique: Air-to-ground 'fire-and-forget'

Essentially a weapon for destroying ground targets, the Maverick is unsurpassed in its 'fire-and-forget' capabilities. Once your tracking camera is on the right target and you get the 'lock-on' signal, fire at once! You will then be free to seek other ground targets.

Rockets



CRV-7 Rocket Launcher

Most effective against:

Factories, Power plants
 Fixed HQs and fortifications
 Aircraft on the ground
 'Soft targets'-trucks etc.

Canadian Rocket Vehicle-7 contains 19 unguided rockets. One of the most effective multi-purpose weapons available for the Harrier. The CRV-7 has a high velocity giving three times the impact energy over earlier rockets.

Impact Velocity: Mach 4 (2950 mph)
 Range: 4 miles
 Weight: 241 kg
 Length : 1.04m
 Drag Factor: 0.03

Laser-Guided Bombs

Laser-guided bombs use a common laser guidance and control assembly with only the aerodynamic surfaces (control fins and aerofoil group) changed to match the particular bomb body.

Most effective in precision attacks against:

Armoured concrete bunkers
 Large factories and power plants
 Road/Rail Bridges
 Non-military buildings
 Fixed HQs and fortifications

HARRIER JUMP JET

Stockpiles

Missile Launchers

Radar equipment fixed/mobile

Armoured Vehicles



Mk 13 1000 lb Paveway Laser Guided Bomb

The British general purpose high explosive bomb fitted with laser guidance system for precision bombing. The basic bomb was developed for the RAF from a WWII bomb design with major changes overcoming kinetic heating problems resulting from low-level high speed flight and an up to date fusing system.

Delivery Altitude: 500 ft +

Weight: 472 kg

Drag Factor: 0.06



GBU-12 Paveway II 500lb Laser Guided Bomb

American low drag general purpose bomb fitted with laser guidance system for precision bombing. The laser guidance kit fitted to the bomb aims the bomb at the target which has been illuminated by laser energy from the delivery aircraft or a ground observer.

Length: 3.33 m

Diameter: 273 mm

Tailspan: 933 mm

Weight: 225 kg

Delivery Altitude: 500 ft +

Drag Factor: 0.04



GBU-16 Paveway II 1000lb Laser Guided Bomb

US Marine Corp laser guided glide bombs work at an effective range of 2 km per 1000 metres of altitude. Attack technique is by toss (500 ft and climb) or level bombing (2000 ft and turn away).

Paveway II was developed in the 1970s using advanced electronics and an aerofoil which helped sensitivity and manoeuvrability. The system does not require modification to the delivery aircraft. It is dropped in the same manner as conventional bombs.

Delivery Altitude: 500 ft +

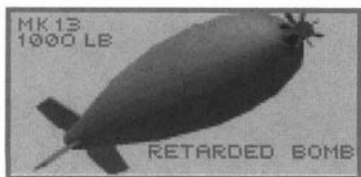
Drag Factor: 0.05

Retarded Bombs

Retarded bombs are standard free-fall bombs but with a retarding tail fin fitted.

Most effective in low-level non-penetrating attacks against:

- Non-military buildings
- Stockpiles
- Airfield Tower/Control/Radar
- Aircraft on Ground
- Fixed HQs and fortifications
- 'Soft targets'- trucks etc.



Mk.13 1000lb GP HE Bomb + Type 117 Retarding Tail

RAF general purpose high-explosive bomb fitted with a retarding tail unit for low level delivery. All 1000 lb bombs are of medium capacity which means that they they have an explosive filling between 40-60% of the total bomb weight

Delivery Altitude: 250 ft +

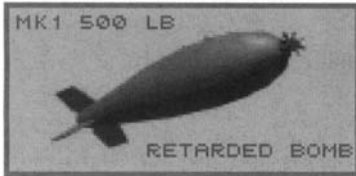
Weight: 482 kg

Length: 1.26 m

Diameter: 420 mm

Drag Factor: 0.06

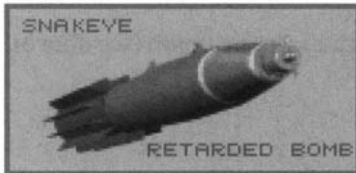
HARRIER JUMP JET



Mk 1 500 lb GP HE Bomb + Type 118 Retarding Tail

British general purpose high-explosive bomb fitted with a retarding tail unit for low level delivery. The Mk 1 has explosive filling which is suitable for high temperature flight conditions.

| | |
|--------------------|----------|
| Delivery Altitude: | 250 ft + |
| Weight: | 296 kg |
| Length: | 1.04m |
| Diameter: | 330 m |
| Drag Factor: | 0.04 |



Mk 82 500 lb GP Bomb + Mk 15 'Snakeye' Retarded Tail

US low drag general purpose bomb fitted with a retarding tail unit for low-level delivery. It is a standard design adopted by many bomb producing countries.

| | |
|--------------------|----------|
| Delivery Altitude: | 250 ft + |
| Length: | 2.21 m |
| Diameter: | 273 mm |
| Weight: | 241 kg |
| Drag Factor: | 0.03 |

Free-Fall Bombs

Most effective against general targets that have to be penetrated:

Airfield Tower/Control/Radar

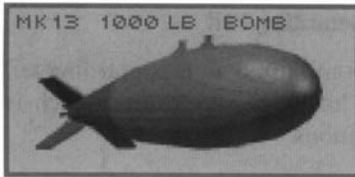
Non-military buildings

Stockpiles

Road/Rail Bridges

'Soft targets' - trucks etc.

Light armoured vehicles

**Mk 13 1000 lb GP HE Bomb**

RAF standard 1000 lb general purpose high-explosive bomb

Delivery Altitude 500 ft + (see above).

Weight: 434 kg
 Length: 1.26 m
 Diameter: 420 mm
 Filling: RWA HE 180 kg
 Drag Factor: 0.06

**Mk 1 500 lb GP HE Bomb**

RAF standard 500 lb general purpose high-explosive bomb (see above).

Delivery Altitude 500 ft +

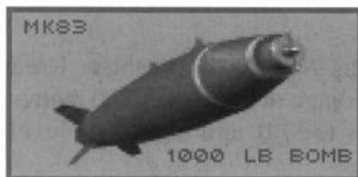
Weight: 261 kg
 Length: 1.04 m
 Diameter: 330 mm
 Filling: HE/RWA
 Drag Factor: 0.04

**Mk 82 500 lb GP HE Bomb**

USMC standard 500 lb low drag general purpose bomb (see above).

Delivery Altitude: 500 ft +
 Weight: 241 kg
 Length: 2.21 m
 Diameter: 273 mm
 Filling: 87 kg Tritonal, Minol or H-6
 Drag Factor: 0.03

HARRIER JUMP JET

**Mk 83 1000 lb GP HE Bomb**

USMC standard 1000 lb low drag general purpose bomb.

| | |
|--------------------|------------------------|
| Delivery Altitude: | 500 ft + |
| Weight: | 447 kg |
| Length: | 3.0 m |
| Diameter: | 350 mm |
| Filling: | 202 kg Tritonal or H-6 |
| Drag Factor: | 0.04 |

Cluster Bombs

A cluster bomb is a weapon that can yield a high 'kill' probability against a wide range of small hard and soft battlefield targets while reducing attacking aircraft losses with a very low level attack profile.

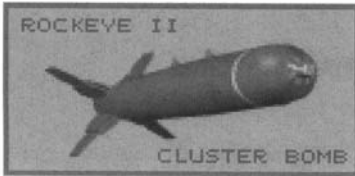
They are most effective using an area blast against:

- Aircraft on Ground
- Non-military buildings
- Stockpiles
- Large missile launchers
- Radar equipment fixed/mobile

**BL755**

This British-made cluster bomb is made up of 147 shaped-charge bomblets with a fragmenting warhead casing. Works with a shot-gun type scatter for high effectiveness making it immune to ECM and devastating over a large area.

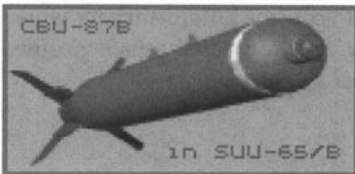
| | |
|--------------------|-------------------------------------------|
| Delivery Altitude: | 250 ft to 3500 ft |
| Weight: | 277 kg |
| Length: | 2.45 m |
| Diameter: | 419 mm |
| Filling: | 147 bomblets (each with HE shaped charge) |
| Drag Factor: | 0.05 |



'Rockeye' II Cluster Bomb

US high explosive cluster bomb containing 247 Mk 118 bomblets. Used against almost any target at an effective range of 2 km per 1000 metres of height. Attack technique is by toss (500 ft and climb) or level bombing (2000 ft and turn away).

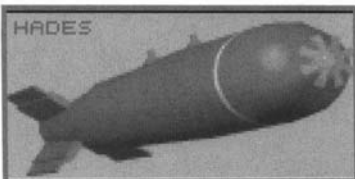
| | |
|--------------------|---------------------------------------------------|
| Delivery Altitude: | 250 ft to 3500 ft |
| Weight: | 222 kg |
| Length: | 2.33 m |
| Diameter: | 335 mm |
| Filling: | 247 bomblets (each weighing 0.6kg filled with HE) |
| Drag Factor: | 0.04 |



CBU-87B CEM (Combined Effects Munition)

The American CEM is in effect the SUU-65/B Tactical Munitions Dispenser (TMD) with a load of 202 BLU-97/B bomblets. These bomblets are multi-purpose with a shaped charge warhead capable of penetrating 177 mm of armour.

| | |
|--------------------|-------------------|
| Delivery Altitude: | 200 ft to 3500 ft |
| Weight : | 430 kg |
| Length: | 2.33 m |
| Diameter: | 396 mm |
| Filling: | 202 Bomblets |
| Drag Factor: | 0.05 |



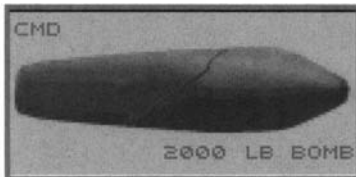
HADES Area Denial Weapon System

The British **H**unting **E**ngineering **A**rea **D**ENial **S**ystem was developed as an air-delivered weapon for the attack and destruction of high value fixed targets such as airfields, road, rail and river crossings, munitions dumps and HQ sites. It contains 49 HB 876 delayed action sub munitions, for area denial missions. After release the sub-munitions are ejected and are parachute-retarded to reduce ground impact velocity.

HARRIER JUMP JET

| | |
|--------------------|--------------------------|
| Delivery Altitude: | 250 ft to 3500 ft |
| Weight: | 259 kg |
| Length: | 2.45 m |
| Diameter: | 419 mm |
| Filling: | 49 submunitions (HB 876) |
| Drag Factor: | 0.05 |

Anti-Runway Weapons

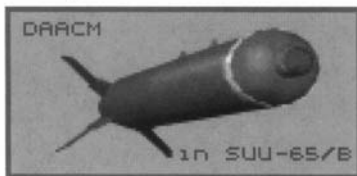


CMD 18 2000lb Anti-Runway Weapon

Cratering Munitions Dispenser.

A British design based on the JP233 cratering bomblet dispenser, it contains 18 SG 357 cratering bomblets (each with two warheads) for use against runways. On impact, the first warhead detonates and allows the second warhead to penetrate below the runway surface. When the second warhead explodes it produces a large rubble strewn crater.

| | |
|--------------------|-------------------------|
| Delivery Altitude: | 200 ft to 3500 ft |
| Weight: | 900 kg |
| Length: | 4.29 m |
| Width: | 656 mm |
| Depth: | 640 mm |
| Filling: | 18 SG 357 sub-munitions |
| Drag Factor: | 0.12 |



DAACM (in SUU-65/B)

Direct Airfield Attack Combined Mmunition

An airfield attack weapon developed in the US by Textron Defence, it contains 8 penetrating units (BLU-106/B) and 24 Hunting Engineering HB 876 area denial munitions. The penetrating units are released on a parachute and fired into the runway when at an angle of 65°. The warhead does not detonate until it is some way under the surface thus causing severe cratering.

Delivery Altitude: 250 ft to 3500 ft

Weight: 907 kg

Length: 1.63 m

Diameter: 388 mm

Filling: 8 BLU-106/B & 24 HB-876 bomblets

Drag Factor: 0.05

Fuel-Air Munitions

Most effective against:

- Non-military buildings
- Fixed HQs and fortifications
- Stockpiles
- Large missile launchers



CBU-55/B Fuel Air Bomb

This US Fuel/Air Explosive takes its oxygen from the atmosphere making it light and compact. FAEs produce a very high impulse making them effective against 'soft targets' and as mine clearing systems. CBU-55/B contains three BLU-73/B sub munitions which are cylindrical canister type bombs fitted with retarding tail units. At about 9 metres from the surface it creates an aerosol type cloud of fuel and air about 18 metres in diameter. The cloud sinks to the surface and is then ignited. This sets up a rapidly expanding wavefront and an overpressure of about 22 kg/sq cm which provides the destructive effect of the weapon.

HARRIER JUMP JET

| | |
|--------------------|-------------------------------------------------------------|
| Delivery Altitude: | 200 ft to 3500 ft |
| Weight: | 250 kg |
| Length: | Not in public domain |
| Diameter: | Not in public domain |
| Filling: | 3 BLU-73/B submunitions (each with 33 kg ethylene oxide) |
| Drag Factor: | 0.04 |

Other Supplies

Reconnaissance

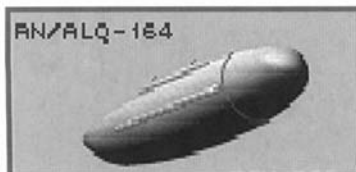


Recon Pod

Contains cameras and infra-red equipment.

| | |
|-----------------|-------------------|
| Photo Altitude: | 500 ft to 2000 ft |
| Weight: | 404 kg |
| Targets: | Any |
| Drag Factor: | 0.05 |

The pod contained a 135 mm high resolution camera for use in visible light and a second camera for infra-red thermal photography. Both photographs are taken simultaneously under pilot control and the pilot can view through either.



ECM

AN/ALQ-164 ECM Pod

Electronic Counter Measures Pod

| | |
|--------------|--------|
| Weight: | 243 kg |
| Drag Factor: | 0.04 |



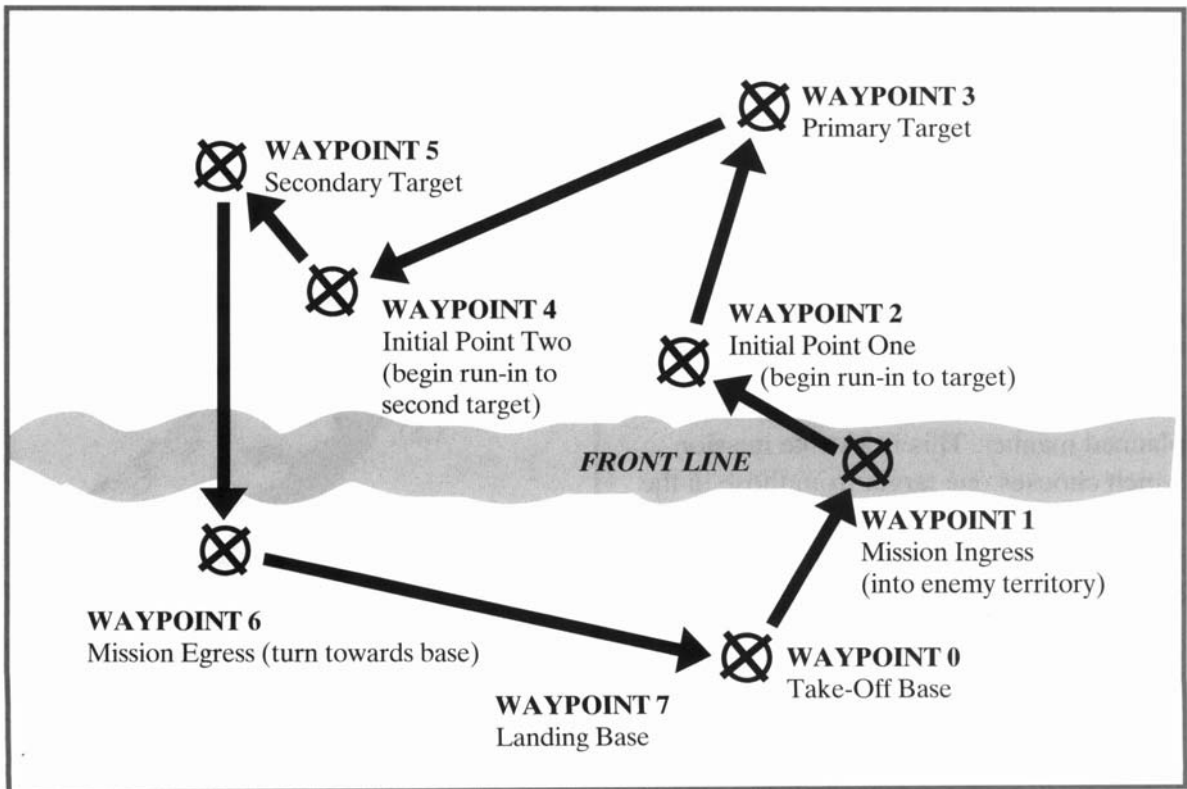
**MISSION
TYPES**

HARRIER JUMP JET

MISSION TYPES

Air-to-Ground Missions

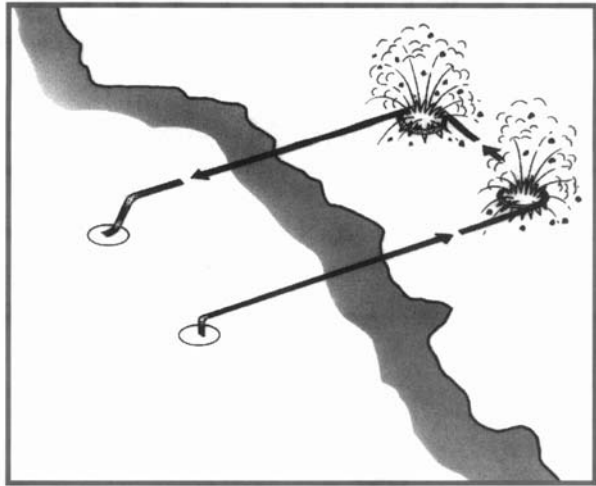
A Harrier ground attack mission has 8 waypoints shown on your HUD information:



The following diagrams do not show all waypoints

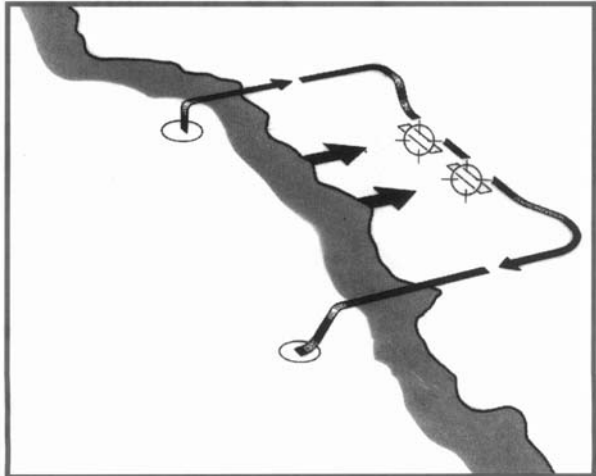
Deep Strike Missions

Against enemy targets well behind front line. Primary and Secondary targets are usually fixed enemy sites (SAMs, airfields, supply dumps, coastal defences or concentrations of enemy forces away from the immediate battle area.



Ground Support Missions

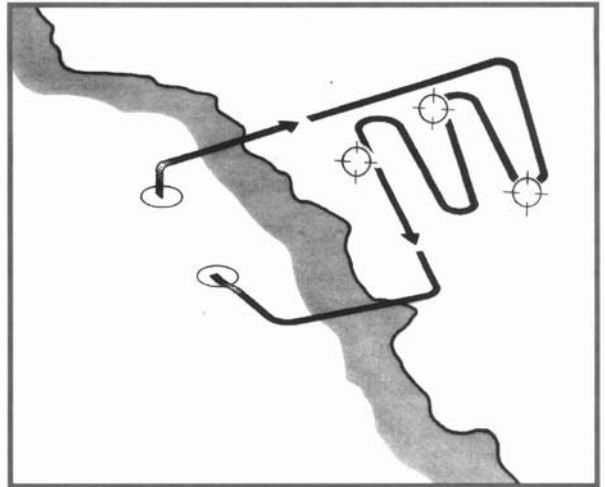
Work with your own ground troops in a planned manner. This is a strike mission which chooses one target from those in the closest front line enemy zone. Friendly ground forces are always near so care must be taken where bombs are dropped.



HARRIER JUMP JET

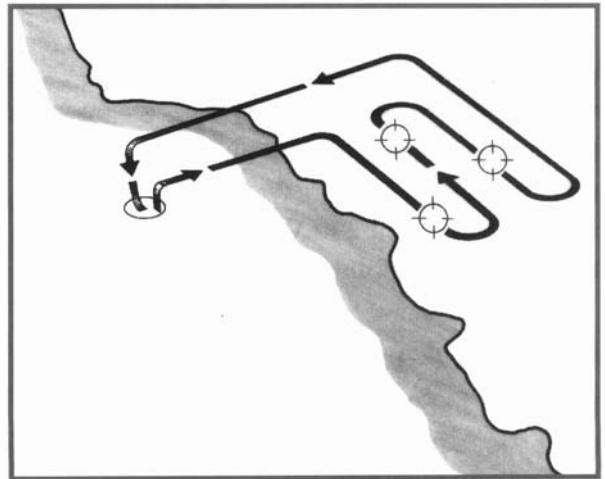
Iron Hand AAA & SAM Suppression

'Iron Hand' is a Vietnam war term for anti-SAM and AAA (radar guided) missions. Attack and destroy enemy AAA and SAM sites in a particular area; a preparatory sortie for a major strike mission.



Interdiction

Behind enemy lines to destroy all ground targets encountered in the area (like Deep Strike mission but on an area basis).



Air-to-Air Missions

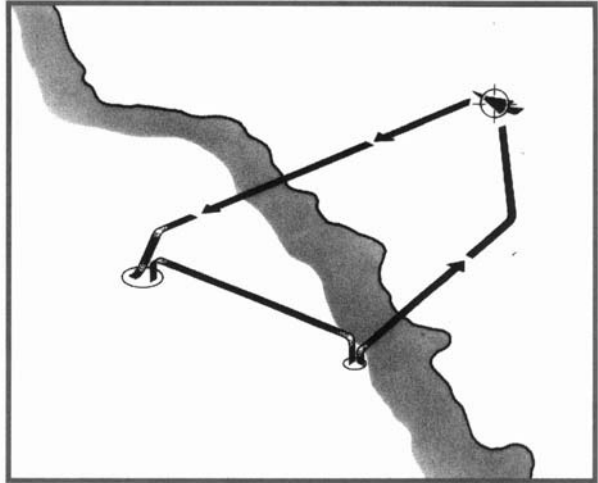
Air Intercept Missions

As Interdiction (above) but to destroy specific high value aircraft.

Overfly Waypoint 1.

Intercept and destroy flight of enemy aircraft taking off from enemy airbase (Waypoint 2).

Return to base via Waypoint 3 and Waypoint 4

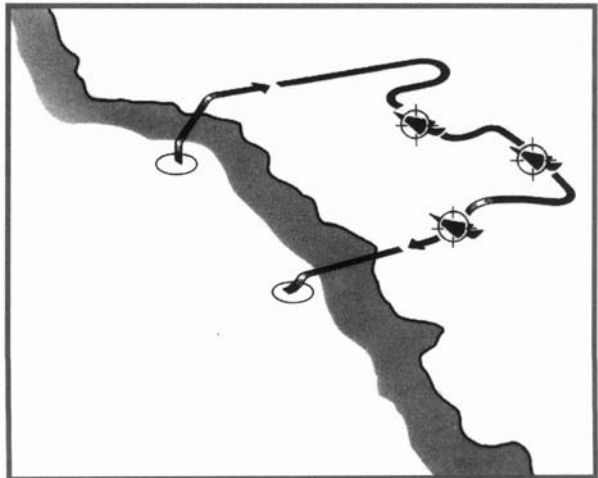


CAP/BARCAP Missions

Fly the patrol route shown on the mission map, from your base to Waypoint 1. Then fly over Waypoint 2 to Waypoint 3. Return to base via Waypoint 4.

Combat Air Patrol (CAP)

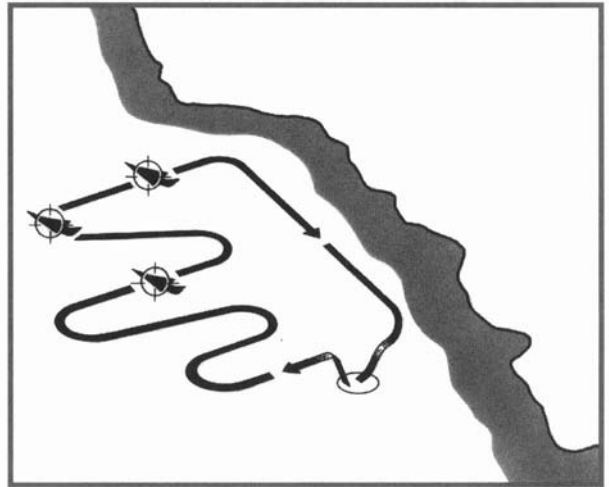
Destroy a number of aircraft (flight/squadron) in a given area or route over enemy territory.



HARRIER JUMP JET

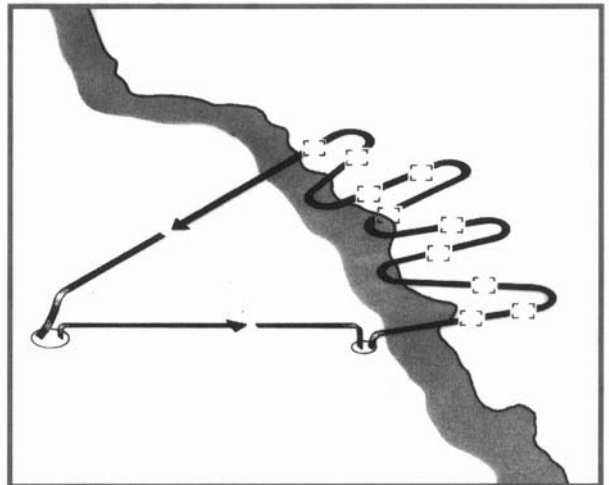
BARCAP

In BARrier Combat Air Patrol missions you will stay behind your own lines and patrol over a given route or area of friendly territory with the aim of stopping enemy aircraft passing through.



Reconnaissance Missions

You will be given a route to overfly and specific targets to photograph. Waypoints are the same as those in Air-to-Ground missions.





**DAILY
Globe**

Saturday, 25 April 1996



TENSION MOUNTS ON CHINESE BORDER



**THE
News**

Thursday, 23 April 1996

China Refuses to Back Down Over Hong Kong



The Daily Messenger

Monday, 27 April 1996

China disregards UN resolution. Allied forces on war alert.

Preparations for handing over Hong Kong to the People's Republic of China in 1997 have been accompanied by rioting,

faction in Beijing has increased its list of civil rights violations. All promises of special treatment for Hong Kong inhabitants have been withdrawn and all negotiations have ended.

International Relations Deteriorate

Yesterday Great Britain broke off diplomatic relations with Beijing after China began to mass troops on the borders of the New Territories.

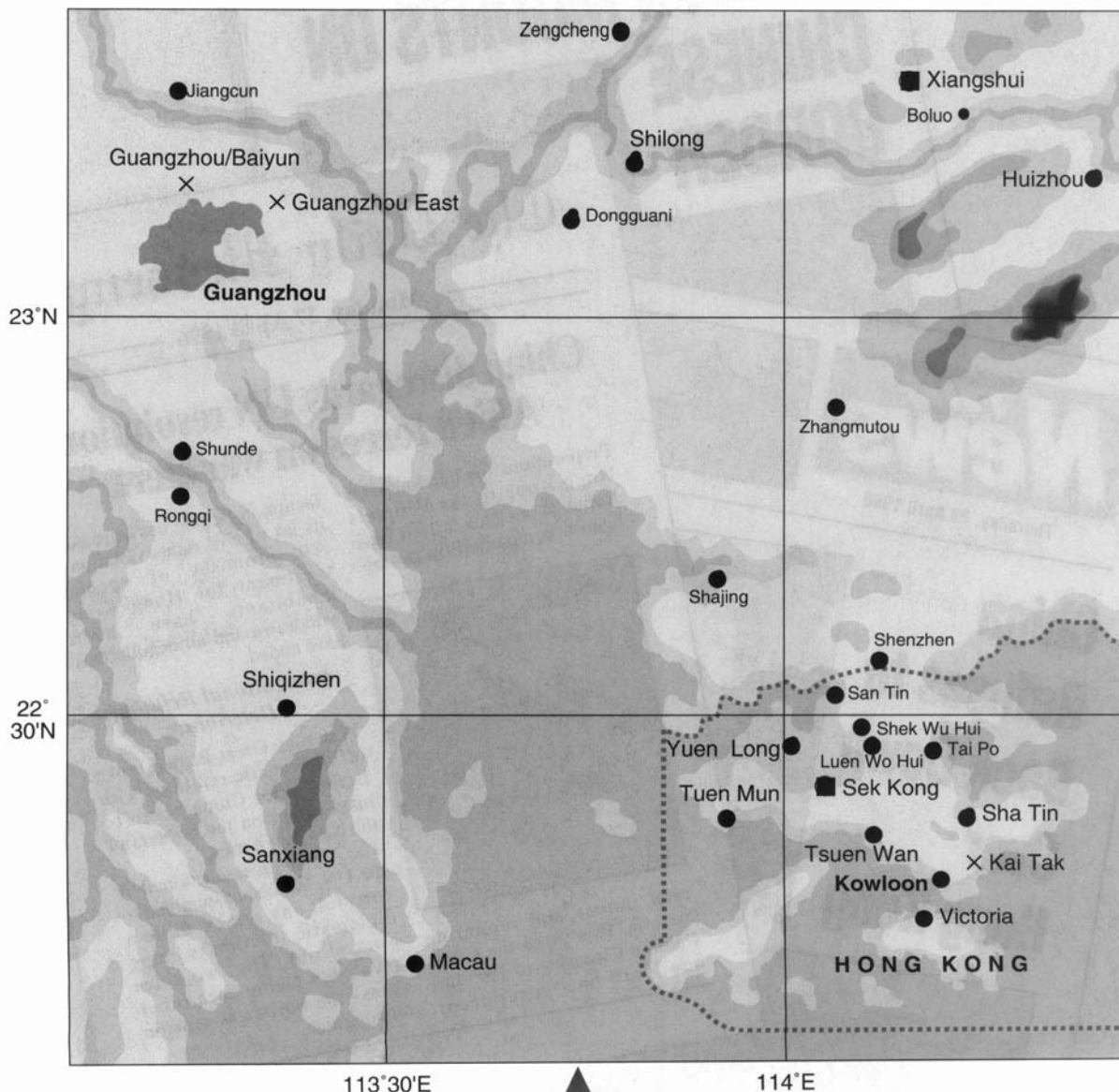
The Allied force, sanctioned by the UN, has been assembled to forestall any attack while a diplomatic solution is being worked out. The two sides have been facing each other across the border as tension remains high.



civil unrest and mounting hysteria. Ever since the Great Cultural Cleansing of 1995 the new 'hard-line' government

HONG KONG

- Town
- X Airfield
- Airstrip



 HARRIER JUMP JET

Hong Kong

April 1996

Preparations for handing over Hong Kong to the People's Republic of China are marked by rioting, civil unrest and mounting hysteria. The rise of a hard-line government faction in Beijing has seen increasing civil rights violations which culminate in the Great Cultural Cleansing of 1995. Promises about special treatment for Hong Kong are withdrawn, negotiations cease and international relations deteriorate. Great Britain breaks off diplomatic relations with China. China responds by massing troops on the borders of the New Territories.

UN resolutions result in an allied force being sent to forestall any attack while a peaceful solution is being worked out. For weeks the two sides face each other across the border. Tension remains high. Then the shooting war begins.

**DAILY
Globe**

Monday, 6 October 1997



UN TASK FORCE SAILS FOR SOUTH ATLANTIC



**THE
News**

Friday, 3 October 1997

Argentine Forces Retake Falklands



The Daily Messenger

Thursday, 10 October 1997

ARGENTINE TROOPS REINFORCE 'FORTRESS MALVINAS'

Determined to wipe out the memory of their defeat in 1982, the new Argentine government has turned the islands into a fortress using defence works installed by the British after the last conflict. All UN resolutions issued ordering Argentina to hand back the Falklands have been ignored. It has now been revealed that the islands were re-taken by Argentine commandos who landed secretly, knocked out radar and communications installations in the Mount Pleasant control centre and paved the way for the landing of a powerful invasion force.

The Air Campaign

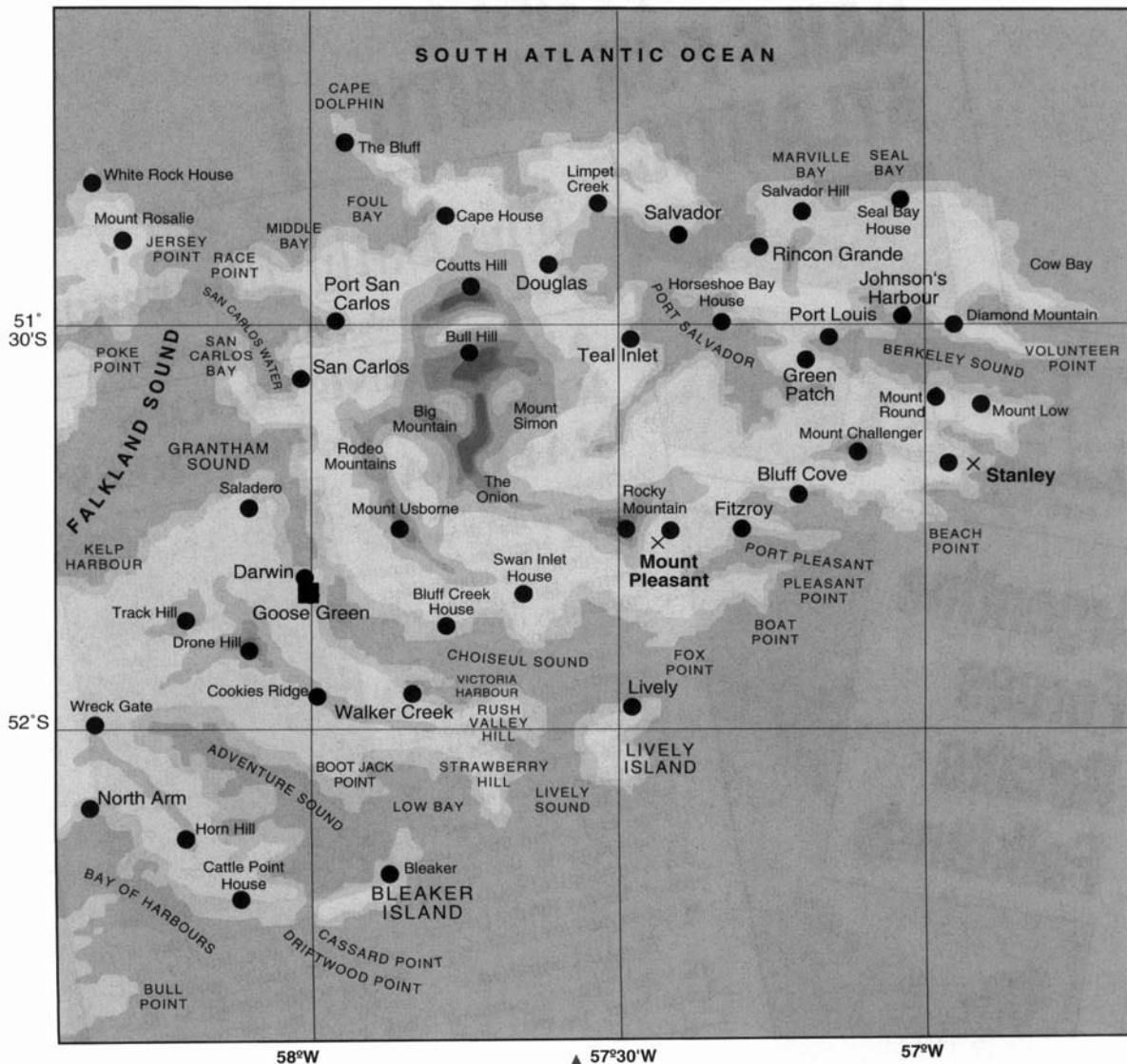
The Allied Task Force that was despatched to the South



Atlantic has now succeeded in creating an exclusion zone around the islands effectively denying reinforcements to the enemy and the air campaign has begun in earnest in advance of allied landings.

FALKLAND ISLANDS

- Town
- X Airfield
- Airstrip



Falkland Islands

October 1997

A night attack by Argentine commandos knocks out radar and communications installations in the Mount Pleasant control centre followed by the landing of a powerful invasion force a few hours later. Determined to wipe out the memory of their defeat in 1982, the new Argentine government soon turns the islands into a fortress using defence works installed by the British after the previous conflict. UN resolutions are issued ordering Argentina to hand back the Falklands but these are ignored. It's not long before a strong allied force is despatched to the South Atlantic. An exclusion zone is set up around the islands effectively denying reinforcements to the enemy and an air campaign begins in advance of allied landings.

**DAILY
Globe**

Monday, 6 July 1998



Baltic States Crushed By Russian Invaders



The Daily Messenger

Thursday, 30 July 1998

Shooting War Breaks Out Over North Cape

Nordkapp 3 am. The first shots have already been fired across the wastes of Nordkapp in Northern Europe as aircraft from the two rival air forces clashed above Norway. Events that have led to this conflict have succeeded each other moment by moment.

The mass expulsion of western diplomats last month- and the arrest of many diplomats and foreign businessmen for alleged 'anti-Soviet activities' has been followed by the ruthless suppression of the formerly free Baltic States and the state seizure of western-leased oil facilities.

The UN sanctioned build-up of NATO forces on the Russian borders, was partly to police the trade embargo and partly to counter Soviet troop concentrations. Last week, it was reported that a Soviet frigate had

clashed with UN ships enforcing the embargo at Svartnes. Shots were fired and three Russian vessels reported sunk in the short engagement which followed. Pravda has lost no time in accusing the UN of 'piracy' and 'violation of Soviet territorial waters'. 'Force', it declared ominously, 'will be met with force!'

The clash in the air happened hours after a similar announcement on Radio Moscow.

It is thought by many commentators that the Russian forces are still scattered, and communications are still poor as the new command structure asserts itself. The Allied strategy must be to win the war quickly and decisively thereby avoiding a war of attrition.

**THE
News**

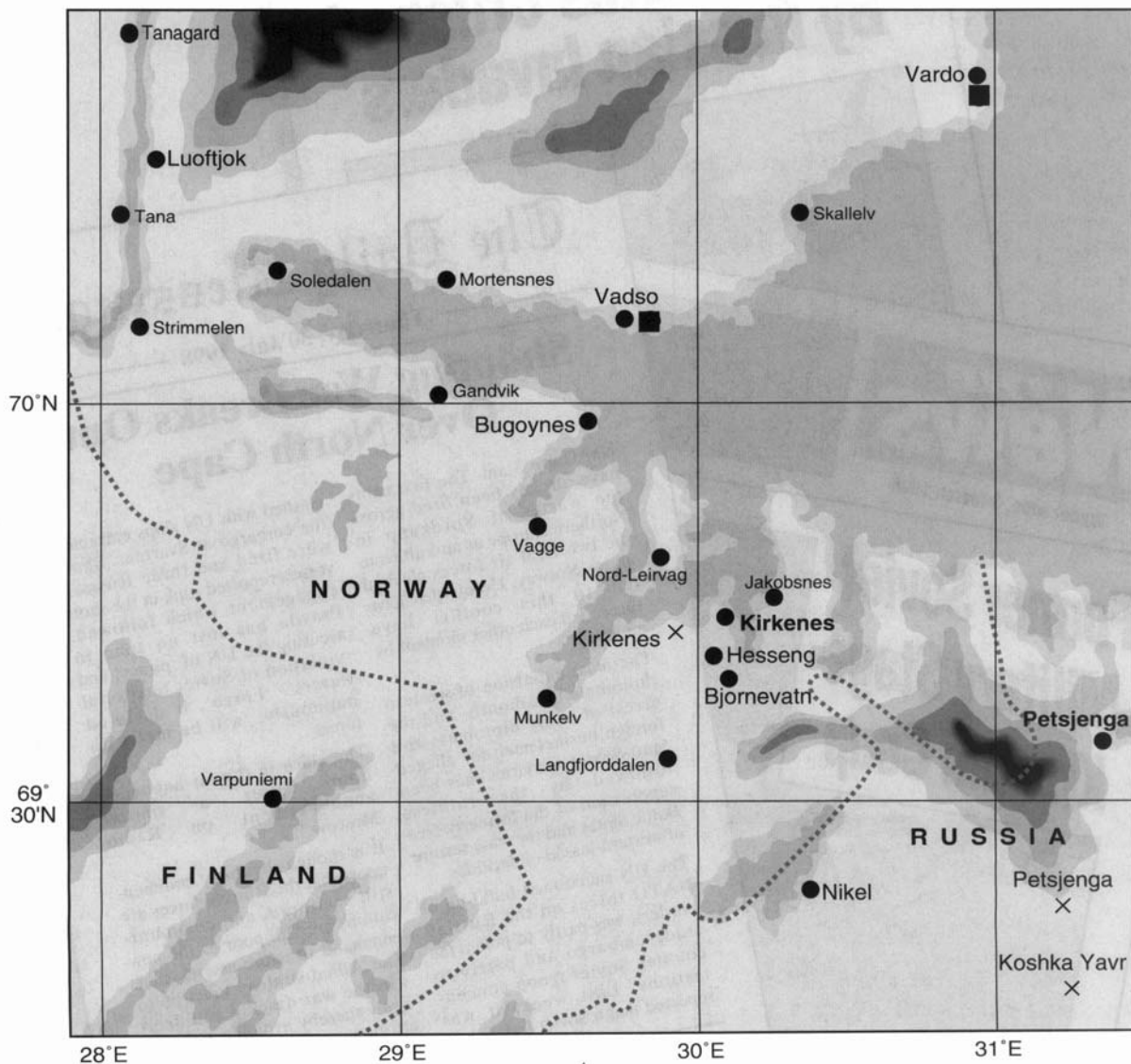
Wednesday, 3 March 1998

Former Soviet Military Stage Kremlin Coup



NORDKAPP

- Town
- X Airfield
- Airstrip



HARRIER JUMP JET

Nordkapp

North Cape, July 1998.

Hard-liners in the former Soviet military stage a coup, taking over the Kremlin in March and start to rebuild the communist superpower of the Brezhnev era. Despite world protests, the Baltic states are ruthlessly re-integrated into the new-style Union, and St. Petersburg is once again called Leningrad after the brutal suppression of democratic sympathisers there. A succession of trade embargoes and UN resolutions have no effect except to force the Russians to walk out of the Security Council. Fighting continues

in Central Asia and the Balkan states, but the western half of the Union is dominated by military force from Moscow.

The mass expulsion of western diplomats - and the arrest of many diplomats and foreign businessmen for alleged "anti-Soviet activities" - is followed by the state seizure of oil facilities which had been leased to a western consortium in 1994. The UN sanctions the build-up of NATO forces on the Soviet borders, partly to police the trade embargo and partly to counter Soviet troop concentrations.



A squadron of Harriers in snow camouflage

At the start of July, a Soviet frigate clashes with UN inspectors enforcing the embargo at Svartnes. The first shots are fired and three vessels are sunk in the short engagement which followed. The next day, Pravda accuses the UN of piracy and violating Soviet territorial waters. The newspaper warns everyone that force will be met with force. Soviet ships fire on salvage vessels sent in to repair a crippled UN ship, and Soviet fighters engage a NATO air patrol across the Norwegian border. Both sides have publicly stated their reluctance to resort to nuclear weapons.

The Soviet forces are still scattered, and communications are still poor as the new command structure asserts itself. The allied strategy is to win this war quickly, before it slows down into a war of attrition.



**HARRIER
KEY GUIDE**



HARRIER JUMP JET

HARRIER KEY GUIDE

Engine Power and Nozzle Controls

| | |
|-------------------------|--------------------------------------------------------------------|
| Key Plus + | Throttle up |
| Shift/Plus + | Throttle to maximum setting |
| Minus Key - | Throttle down |
| Shift/Minus - | Throttle to minimum setting |
| Open Square Brackets [| Nozzle angle increases (towards 98°, straight down) |
| Close Square Brackets] | Nozzle angle decreases (towards 0°, straight back) |
| Shift / [| Nozzle angle to 98° |
| Shift /] | Nozzle angle to 0° |
| Key [(Tap) | Nozzle Key; one tap sets nozzles to 55°, when Harrier is on ground |

The Keyboard Flight Controller

| | |
|--------------|-----------------------------------------------------------------------|
| numeric 8 | Push forwards on stick |
| numeric 4 | Pull back on stick |
| numeric 5 | Centre all controls and level out (<i>simple flight model only</i>) |
| numeric 6 | Roll aircraft right |
| numeric 2 | Roll aircraft left |
| cursor up | Push forwards on stick |
| cursor down | Pull back on stick |
| cursor right | Roll aircraft right |
| cursor left | Roll aircraft left |



Testing one of the first GR.7s built

General Flight Controls

| | |
|----------|-----------------------------|
| Key A | Autopilot on/off toggle |
| Key B | Airbrake/Wheelbrake on/off |
| Key G | Landing gear up/down toggle |
| Key W | Select (next) Waypoint |
| Shift /W | Select (previous) Waypoint |

HARRIER JUMP JET

| | |
|--------------|------------------------------------------------|
| Alt/E | Eject |
| Alt/ J | Jettison all air-to-ground weapons/ 'clean up' |
| Alt/ F | Dump Fuel |
| Key 0 (Zero) | Auto-Hover (<i>simple flight model only</i>) |
| Key < | Rudder left |
| Key > | Rudder right |

Displays

| | |
|---------------------|---------------------------------------------------------|
| TAB Key | HUD Mode select (cycle through VSTOL, NAV and A/G) |
| Key H | HUD on/off toggle |
| Key Z | Left MFD screen cycle up |
| Shift/Z | Cycle left MFD down |
| Key X | Right MFD screen cycle up |
| Shift/X | Cycle right MFD down |
| Keyboard 6 or Key S | Alter MFD tactical compass scale (1x-16x cycle through) |
| Shift 6 or Shift S | Opposite effect |
| Keyboard 7 | Moving map MFD waypoints on/off |
| Keyboard 9 | Mission briefing reminder (on right MFD) |
| Keyboard 8 | Toggles tactical compass course bar on/off |

Weapon Controls

| | |
|-----------------|----------------------------------------------------------------------------------------------------------------------|
| Backspace | Target Acquire |
| Shift/Backspace | Designates Waypoint as a target |
| Alt/L | Break lock |
| Key M | Attack/Scan mode select toggle/cycle (context sensitive to current weapon type selected) |
| Space Bar | FIRE!/Release (salvo of) selected weapon(s) |
| Return | Weapon Type Select (cycle through weapons available) |
| Keyboard 1 | Set 1 (appropriate) selected weapon in salvo |
| Keyboard 2 | Set 2 (appropriate) selected weapons in salvo |
| Keyboard 3 | Set 4 (appropriate) selected weapons in salvo <i>or release all of weapon available, if fewer than 4 on board</i> |
| Keyboard 4 | Set all (appropriate) selected weapons on aircraft in salvo |
| Key N | NVG/FLIR on/off |

Defence Controls

| | |
|-------|------------------------------------------------------------------------------------------------------------------------|
| Key D | Auto Defences on/off toggle |
| Key E | ECM on/off toggle (This applies to the RAF Zeus system, but only applies to the AV-8B when the AN/ALQ pod is carried.) |
| Key F | Flare Eject (Manual) |
| Key C | Chaff Eject (Manual) |

Camera and View Controls

Cockpit Views

Function Keys

| | |
|----|------------------------------------------------|
| F1 | Left back (over the shoulder) in-cockpit view |
| F2 | Left side in-cockpit view |
| F3 | Forward in-cockpit view |
| F4 | Right side in-cockpit view |
| F5 | Right back (over the shoulder) in-cockpit view |
| F6 | Up (head back) in-cockpit view |

Tactical Views

| | |
|-----------|-------------------------------------------------------------------------------------------------------------------------------------------------------------------------------------------------------------------------------------------|
| F7 | Tactical Camera View You are positioned behind the Harrier looking past it at the target being tracked on the aircraft's HUD. This view rotates and pans to keep the Harrier and its target in view. |
| Shift/ F7 | Inverse Tactical Camera View You are positioned behind the Harrier's target looking past it at the Harrier. The target may be another plane or a ground target. This view rotates and pans to keep the Harrier and its target in view. |
| F8 | 'Free-flying' Camera View Select 'Free-flying Camera (see below) |

HARRIER JUMP JET

Free-Flying Camera Views

| | |
|---------------|--------------------------------------------------------------------|
| Numeric / | 'Free-flying' camera view: cycle 'up' through simulation objects |
| Numeric * | 'Free-flying' camera view: cycle 'down' through simulation objects |
| Numeric Pg Up | Rotate 'free-flying' camera up 'over' object |
| Numeric Pg Dn | Rotate 'free-flying' camera down 'under' object |
| Numeric Ins | Rotate 'free-flying' camera left round object |
| Numeric Del | Rotate 'free-flying' camera right round object |
| Numeric - | Zoom out (move 'free-flying' camera away from object) |
| Numeric + | Zoom in (move 'free-flying' camera towards object) |
| Key Pad Pg Up | Rotate 'free-flying' camera up 'over' object |
| Key Pad Pg Dn | Rotate 'free-flying' camera down 'under' object |
| Key Pad Ins | Rotate 'free-flying' camera left round object |
| Key Pad Del | Rotate 'free-flying' camera right round object |

Game Controls

| | |
|------------|-----------------------------------------------------|
| Escape Key | Menu Bar and Game Pause on/off |
| Alt/A | Accelerated Time mode on/off |
| Alt/B | Boss mode (Hide game on/off) |
| Alt/G | Ground Shading on/off |
| Alt/H | HUD colour cycle |
| L | Last HUD message repeat |
| Alt/Q | Quit to DOS |
| Alt/S | Sound on/off |
| Alt/R | Re-supply Weapons and Fuel (Training Missions Only) |
| Alt/T | Convert to Training Mission |

Game Menus

A number of Game Menus can be accessed by pressing the Escape Key. The simulation will pause and a menu bar appear at the top of the screen. Use your *controller* cursor arrow to open each menu.

| | |
|-------------------|--------------------------------|
| Escape Key | Menu Bar and Game Pause on/off |
|-------------------|--------------------------------|

Quit Menu

- End Mission** The exact purpose of this option varies according to the game type selected by the player:
Training and Instant Flight missions end automatically, as though the player had landed safely at base.
Single missions end immediately. The player lands safely at his base.
Single Day and Campaign missions end immediately, and the player is assumed to have landed safely at base.
- Hide Game** Boss mode (hide game on/off)
- Quit** Return to your computer's Operating System.

Configuration Menu

- Ground Shading** on/off
- Sound Effects** on/off
- Flight Control Method** This brings up a sub-menu, which lists the available control methods for the Harrier.
Joystick
Keyboard
Recalibrate joystick
- Change HUD Colour** This brings up a sub-menu, which lists the available colours for the HUD.

Gameplay Menu

- Change to Training Mission** On Instant Flight this allows the player's Harrier to be refuelled and rearmed.
On Single Missions the player's score is not taken into account.
On Single, Day and Mission Campaigns it is as though the mission had not taken place.
- Weapon Re-supply** Re-supply the Harrier with a full original complement of weapons and fuel and automatically converts the mission to a training mission.

 HARRIER JUMP JET**Lighting Conditions**

This option applies to Training Missions and Instant Flight only.
The player can select the time of day:

Day
Night
Twilight

The following all appear as sub-menus, allowing the player to tailor the game play 'on the wing'.

Flight Model

Simple
Easy
Realistic

Weapons Model

Easy
Moderate
Realistic

Landings

No Crashes
Easy Landings
Realistic Landings

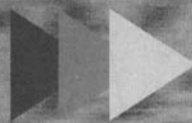
Enemy Air Force Quality

Green
Regular
Veteran
Ace

**Enemy Ground
Forces Quality**


Green
Regular
Veteran
Elite





SECTION

3



HARRIER
AIR AND
GROUND
ATTACKS

HARRIER AIR AND GROUND ATTACKS

Air-to-Ground Missiles

'Fire-and-Forget'

With 'fire-and-forget' missiles such as the Maverick it's just a matter of getting 'lock-on' (indicating a high-accuracy firing solution) and then releasing them. These missiles are extremely effective in destroying ground-based targets so it's wise to wait for your best possible shot. After launch, the missile assumes your course and speed

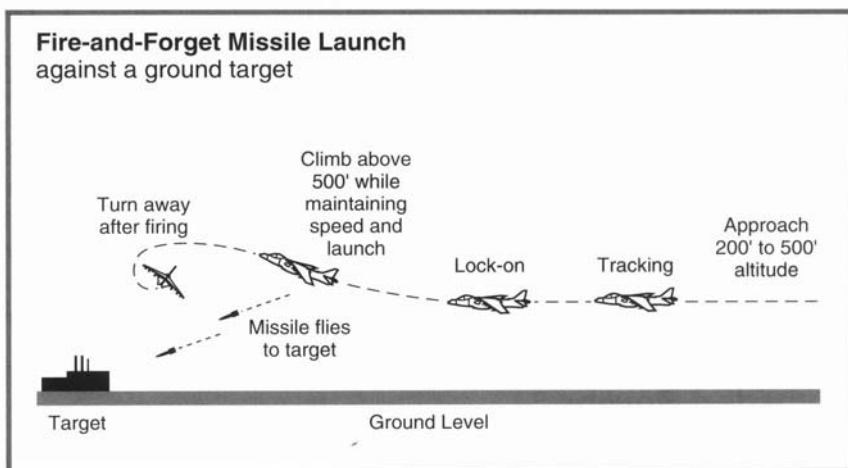
then drops for about 300 feet before its motor fully ignites and accelerates the missile. The missile's maximum range depends on the amount of fuel it has and its initial launch speed; the faster you are flying, the greater the missile's range.

As a general rule do not launch a missile below 500 feet or in a power dive because it may hit the ground before you can fly away.

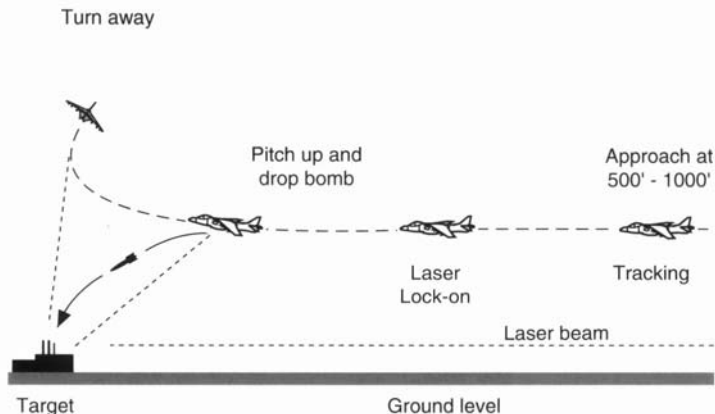
Laser Guided Bombs

These are motorless missiles that glide from your plane to a target 'painted' by a laser controlled by a ground installation.

Glide bombs travel as fast as the launching aircraft. If you release from low altitude, they hit the target about the same time as your plane is passing over it and the explosion will damage or destroy your plane. To counter this problem Harrier pilots will employ the 'toss bombing' method.



Pave Tack Laser - Guided Toss Bombing



Toss Bombing

Approach level at about 500 feet, flying at full speed. When you are 3 to 6 km from the target pitch up into a climb (30° to 40°) and watch for 'lock-on' on your HUD. When this occurs, launch the bomb and turn away.

Level Bombing

You may also 'level bomb' with LGBs. Generally, you will need to attack from at least 2000 feet. From that height you can 'lock' onto the target from 4 km. Attack at once then turn away but remember to keep your underside facing the target. You

can, if you wish, fly over the target but climb to 3000 feet to avoid the explosion. Remember that you will then be a sitting duck for enemy radar and SAMs.

Retarded Bombs

These are unguided bombs fitted with special fins that slow them down very quickly. This allows the bombs to fall behind your aircraft making lower altitude drops safer.

Level Bombing

The standard technique for retarded bombing is to fly straight over the target at low altitude and then release the bomb on the cue from your HUD. If you maintain speed in your bombing run, you can safely release the ordnance from just above 500 feet, and safely avoid the 3000 feet burst area.

Retarded bombs are less accurate than free-fall or laser-guided bombs and will probably miss the target from high altitude. It's also extremely difficult to hit precise targets with them although cluster bomb units (BL755 and Rockeye) give good area coverage to compensate for drop inaccuracies.

HARRIER JUMP JET

Free-Fall Bombs

These are conventional bombs that arc down at high speed toward the target.

Level Bombing

This is the simplest method of dropping free-fall bombs. The same procedure as retarded bombing applies, except that the safe bombing altitude is 3000 feet, instead of 500 feet, making you vulnerable to enemy defenses.

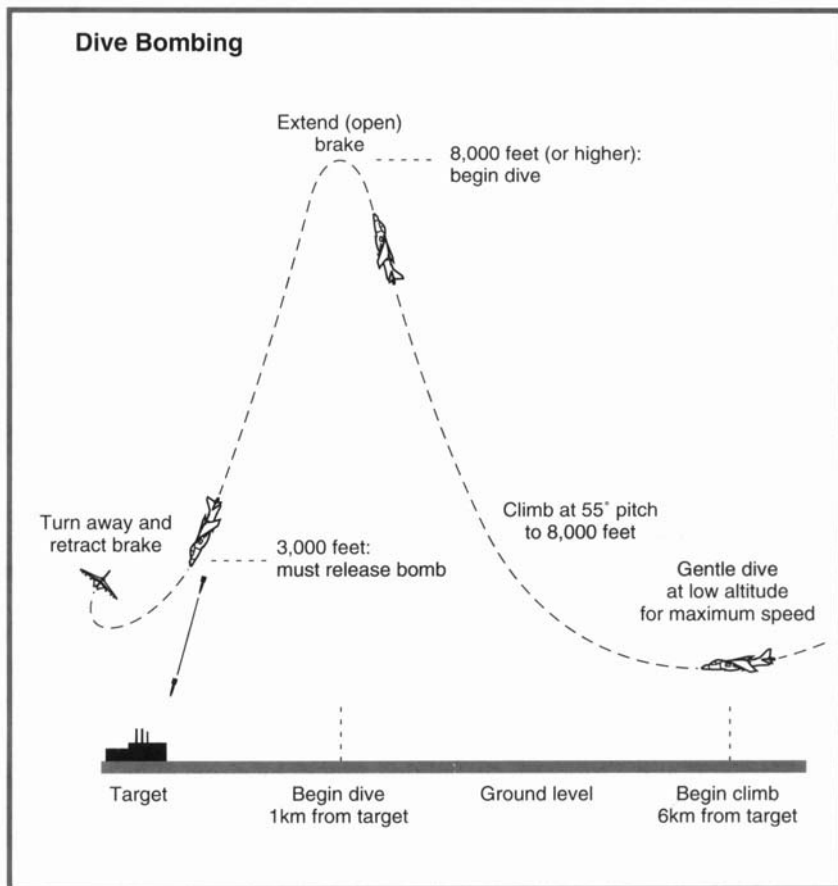
Dive Bombing

This is a more accurate technique for dropping free-fall bombs but requires considerable practice and skill.

To make a dive bombing attack, start by flying low toward the target.

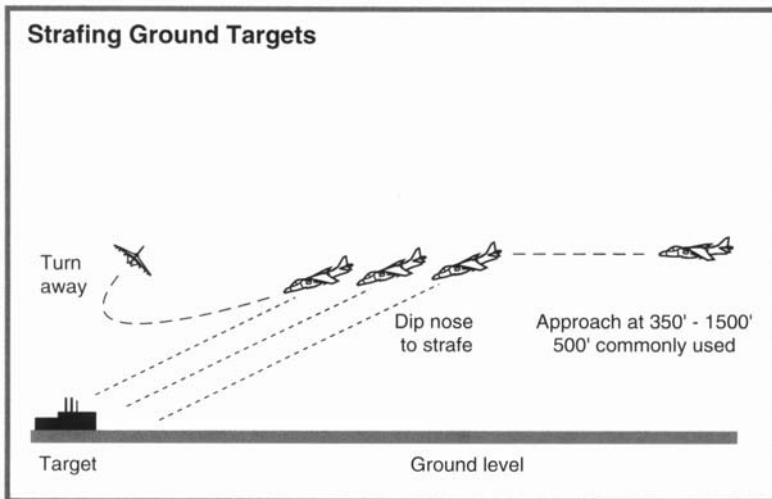
Select your ordnance. When you are 6 km from the target zoom up into a 55° climb to get to 8000 feet.

Your objective is to get to the correct height about 2 km horizontal distance from the target.



Now dive for the target. Level out, tap the air brakes and at just under 1 km from the target, push down in a steep (80°) dive. Now, line up the target with your HUD. Keep an eye on your altitude, if you are below 3000 feet before bomb drop, pull out and try again. Release the bomb and, if there is time, release another bomb immediately then pull up sharp and roll away in a 90° turn. Close the airbrakes.

Climbing to a dive bombing position usually broadcasts your presence to the enemy so it's wise, once you turn away from the target, to check for missile warnings.

Strafing Ground Targets**Reconnaissance**

If you are on a reconnaissance mission you should have a camera pod loaded on your Harrier. You can select the Recon pod like any other ordnance and your HUD information will change to the appropriate type.

To take photographs fly the plane so that the target passes through the centre of the target box. When this happens hit the Fire Ordnance *selector*. You will see a message to confirm if you have taken a photograph successfully.

Camera runs are similar to strafing runs but in this case you can fly level because the camera is slanted slightly down. Remember that flying with air brakes extended slows your speed making it much easier to line up shots.

Air-to-Air Combat

The Harrier has the ability to change the position of its thrust nozzles to give it greater agility in air-to-air combat. Vectoring In Forward Flight (VIFFing) allows the aircraft to perform unique aerial manoeuvres. By using VIFF the Harrier can decelerate very quickly forcing enemy aircraft to fly in front of it; useful if you are trying to out-turn someone on your tail.

The Harrier is also a supreme dogfighting aircraft by virtue of its agility, high thrust-to-weight ratio, small mass, non-smoke engine, cannon, Sidewinder capability and high angle-of-attack flight control system. It also has excellent self-defence capability with its radar warning system; chaff/flare dispensers and jamming systems.

Surprise!

In air-to-air combat, surprise is one of your most important weapons. The best method to ambush an enemy plane is to creep up behind it. Fighter pilots, in general, prefer to attack from above to get an 'energy advantage' in any dogfight. If you are 'bounced' by the enemy, you must look for incoming missiles and take the appropriate defensive action. The basic rule is that missiles travel faster than planes and must be countered first. Only after that can you think about an escape or a dogfight.

HARRIER JUMP JET

Exchanging Missiles

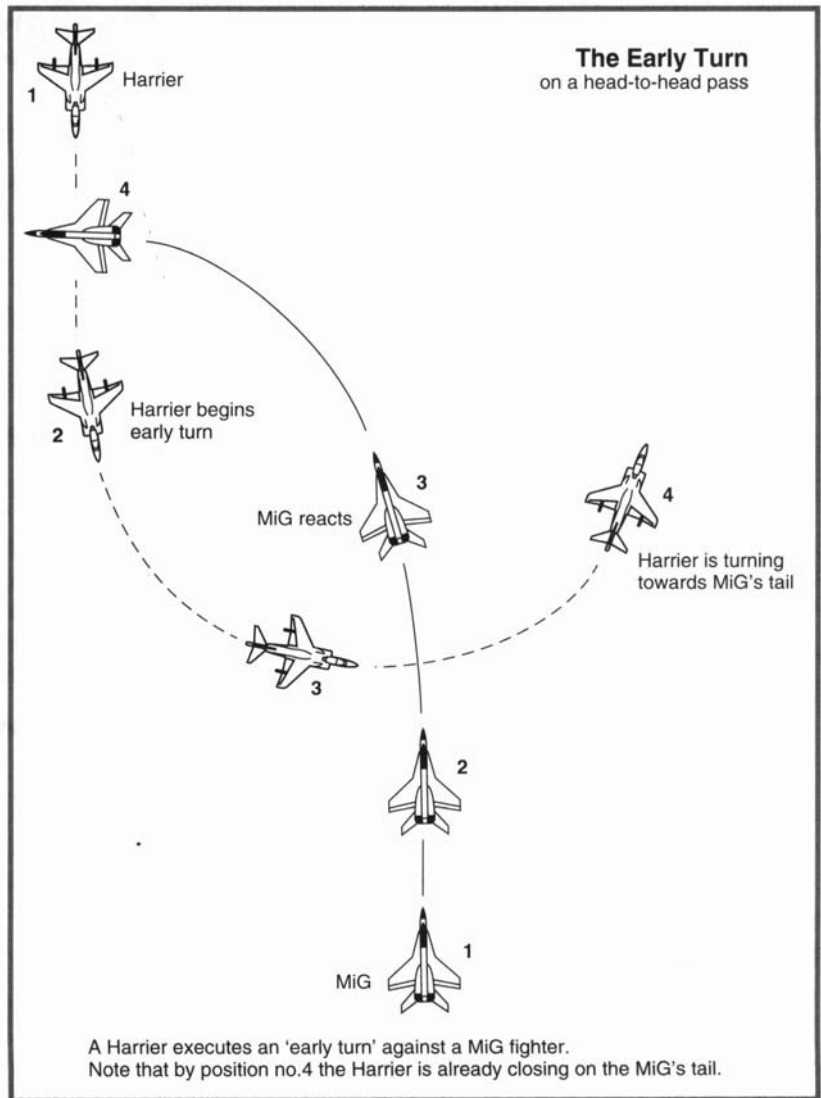
An air-to-air battle usually begins with a head-to-head face-off. Be prepared to set ECM or chaff the incoming. Remember that if you can get off a second missile then so can your opponent; especially if he carries IR missiles (expect them on MiG-29s and Su-27s).

Radar-Homing AAMs

Most radar-guided weapons are semi-active homers: the launching aircraft must continue to 'paint' you with its radar and the missile homes on the 'paint'. Avoid radar-homing AAMs in the same manner as SAMs (see below)

Infra Red (IR) Homing AAMs

All IR homing AAMs are 'fire-and-forget' weapons. To counter them, use the same tactics as against IR SAMs (see below). Many IR homers are usually fired at short range during a dogfight which means you'll have to be fast with the IR defences as soon as you get a launch warning, then dodge away from the missile's 45° field-of-view. If you delay too long drop a flare and dodge, then pray!



A difficult tactic to master in head-to-head duelling but useful especially when dealing with a less experienced pilot. Novice pilots tend to close in hoping for a cannon shot anticipating a turn only after passing you. With a good early turn you can easily get on the enemy's tail.

Dogfights

Get On His Tail!

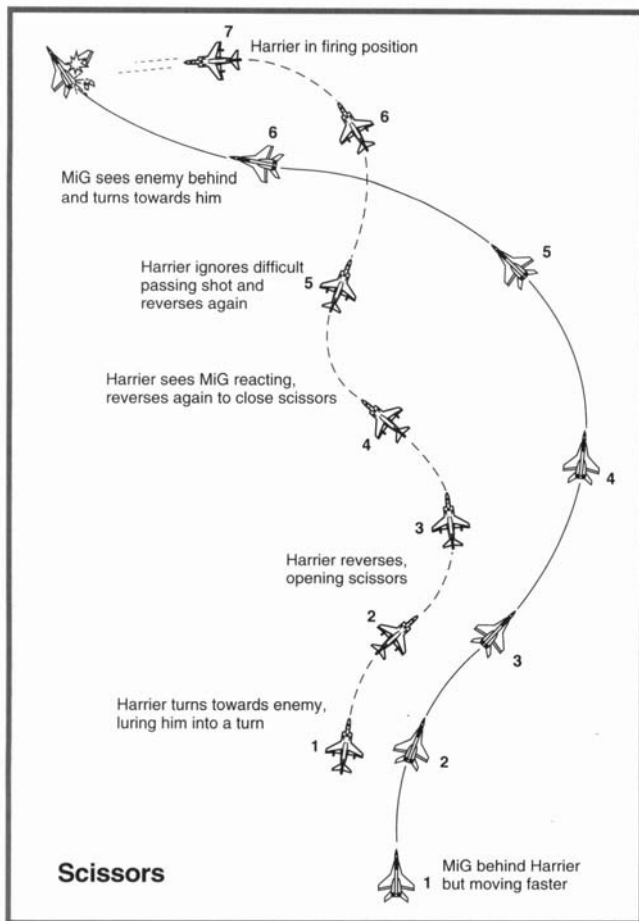
The basic rule in dogfighting is to get behind your opponent. On all fighter aircraft guns and missile systems face forwards and if you're on his tail you can shoot and he can't. If you can't get on his tail try to position his plane in front of you to give you the maximum number of firing opportunities.

Go Faster! Climb Higher!

Maintaining higher speed or altitude is valuable in a dogfight. An aircraft that is slower and lower can only hope to dodge attacks; but an aircraft that is faster or higher has the opportunity to attack or retreat. Being faster or higher than the enemy is termed the 'energy advantage'.

Escape Manoeuvres

The Harrier has its own special methods of shaking off a pursuing plane (see below) but in classic dogfighting terms there are five basic manoeuvres to remove an enemy plane from your tail.



Turning Inside

The easiest solution is to turn towards him (in the enemy plane's direction). In the event of you turning faster than him, you'll eventually circle around and get on his tail. It's quite common to see rookie pilots engaged in a 'turn match', circling around each other. However, if the enemy is turning faster than you, he'll get behind you again. If you don't want to get toasted you must try something else immediately!

Scissors

This is more complex but begins in the same way as *Turning Inside*. Begin to turn towards your opponent but, when he begins to turn with you, roll over to turn in the opposite direction. The scissors are now open!

HARRIER JUMP JET

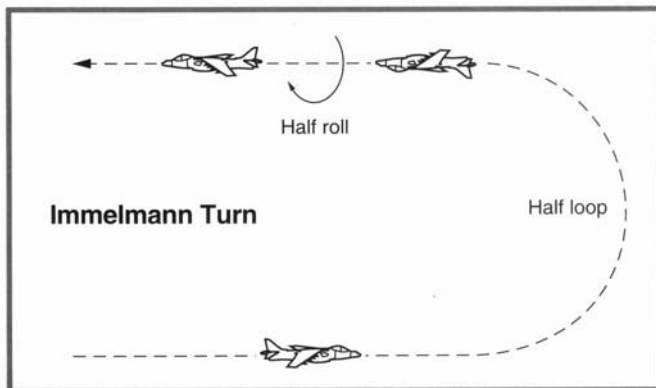
When the enemy realizes you've turned away he should turn back towards you. You then simply roll back towards him again closing the scissors.

If your turns were quicker and tighter than his and/or you are the slower plane, he will eventually pass in front of you. This lets you in on his tail.

Rookie pilots can often be lured into a scissors even if they have a plane that turns faster. Experienced enemy pilots may avoid this tactic by anticipating your next turn and blasting you (if they're slower) or by pulling up and over in a Yo-Yo (if they're faster).

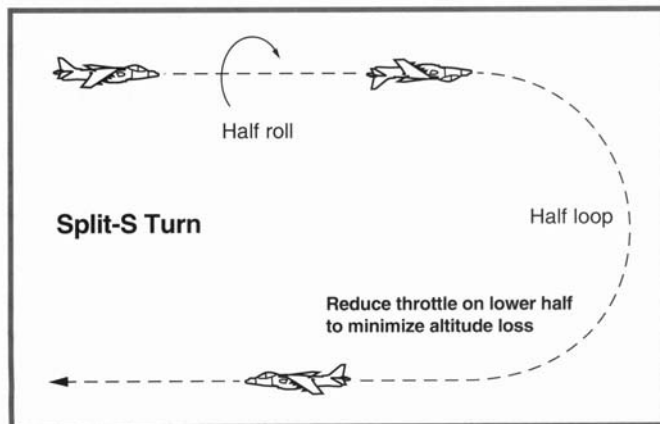
Immelmann Turn

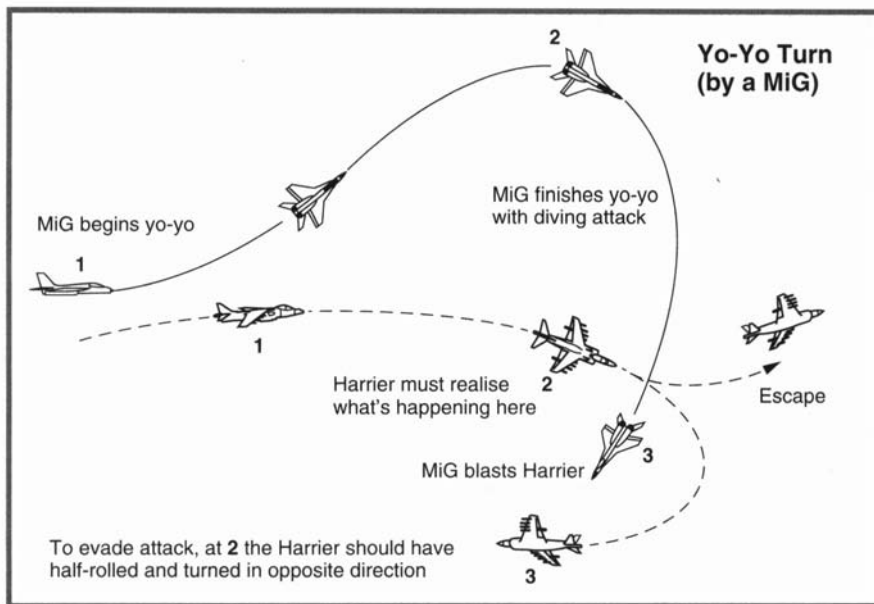
This is useful if you want to reverse direction quickly. Carry out a half loop upwards to reverse direction, then a half roll to right your aircraft. If an enemy is on your tail, an Immelmann will bring you nose-to-nose with him. Be careful when executing an Immelmann; it will give you an altitude gain but at the expense of speed.



Split-S Turn

Almost the opposite to the Immelmann, you begin this manoeuvre by rolling inverted, then pull the stick back to half-loop downward. Many pilots choose to roll the plane while looping. The Split-S causes you to lose altitude so it's often wise to reduce throttle and use air brakes to minimize altitude loss. Be careful using the Split-S into, or away from, the enemy and always keep an eye on the altitude because it's very easy to Split-S straight into the ground.



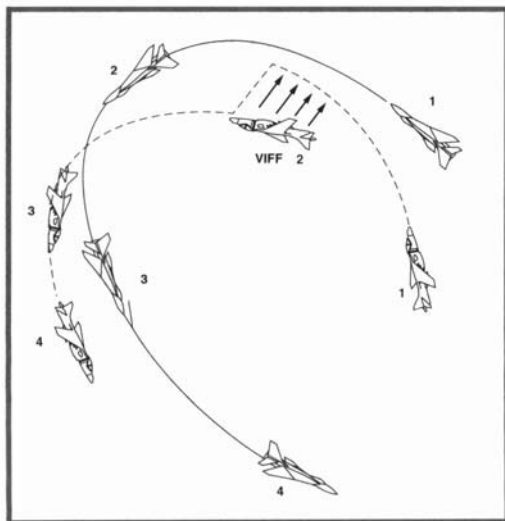


Yo-Yo Turn

A Yo-Yo is used primarily by higher speed jets against slower opponents. The Harrier will have little chance to use it against the fast jets but you may see enemy MiGs trying it against you.

In a Yo-Yo you climb and roll toward the enemy until he's visible out of the top of your canopy, then pull over into a dive while he's still turning. During the dive you roll the plane to help line up your shot

(which is often taken while you are inverted). Basically, a Yo-Yo makes a very big turn in three dimensions. Often the best defence against a Yo-Yo is to reverse your turn and go into a Split-S.



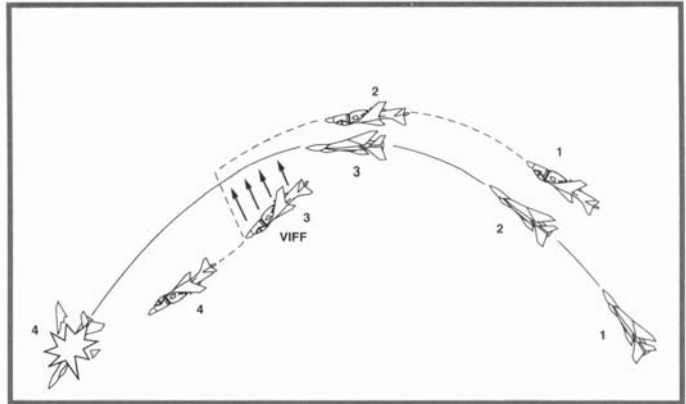
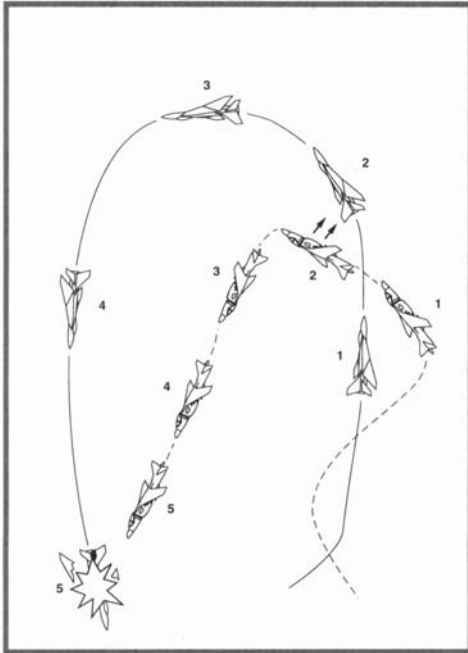
“VIFFing” (Vectoring in Forward Flight)

The Harrier is unique in its ability to change the direction of its thrust to give it greater agility in air-to-air combat. Thrust vectoring (rotating the thrust nozzles) can be used to improve the aircraft's instantaneous turn performance. Put simply, this means that by rotating the thrust nozzles during forward flight the direction of the aircraft's motion can be changed quite radically, causing potential non-STOVL and missile adversaries to overshoot. Much of the development of the VIFFing tactic was carried out by the US Marine Corps.

By pointing the exhaust nozzles downwards relative to the aircraft under slow-speed, low-G conditions, VIFFing can double the instantaneous turn performance. But at high

HARRIER JUMP JET

speed and high-G its effects are minimal. However, since all the thrust is now directed downwards the aircraft will decelerate far more rapidly than a conventional fighter.



VIFFing can also be used to effect a vertical reversal after a zoom climb: this is a shallow climb in which the pilot can trade altitude for airspeed or vice versa without causing a loss of motion energy. If the rear nozzles are rotated downwards when the aircraft is in a near-vertical slow speed zoom climb the effect is to make the aircraft pitch forward, pivoting about its centre of gravity (CofG) and quite literally swapping ends to point itself back down at its attacker. This can be a valuable manoeuvre if the Harrier is equipped with all-aspect air-to-air missiles like the Sidewinder.

Enemy Surface-to-Air Missile Systems (SAMs)

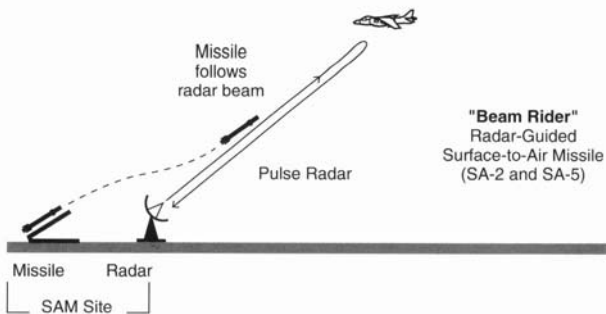
Medium/Long Range SAMs

Medium and long-range SAMs are controlled by radar. All types use the same 3 step process to engage their target.

Radar Search.

Search radar periodically scans the sky (360°) for aircraft.

Radar-Guided SAMs (Surface-to-Air Missiles)



Radar Tracking

When search radar finds something, it 'hands off' the prospective target to a narrow-beam fire control radar, usually running on a different frequency. This finds and 'locks-on' to your aircraft. When the fire control operators are sure their beam is tracking correctly they launch a missile.

Radar Control

After the missile is launched, the ground station continues tracking the plane so the missile's course can be updated and corrected. There are three methods to control the missile's course:

Beam Rider- The SAM is guided along the radar beam toward you.

Semi-Active SAMs- The missile has a radar receiver and computer in its nose. The tracking radar 'paints' your aircraft with a radar signal and the missile nose receiver catches the reflections. The missile homes-in on these reflections until it hits the plane.

Command Guidance SAMs- These missiles use semi-active guidance but, in addition, the firer has a command link to the missile to allow him to override the SAG. This means that if the missile loses guidance, or is otherwise confused, the ground controller can turn the missile around again.

Missile homes on radar reflections

Semi-Active
Radar-Guided
Surface-to-Air Missile
(SA-4,-6,-8 and -11)
(SA-N-4 and SA-N-7)

Pulse or Doppler
Radar

Missile Radar
SAM Site

Missile homes on radar reflections

Semi-Active with
Command Guidance
Surface-to-Air Missile
(SA-10 and SA-12)
(SA-N-6)

Doppler Radar

Command link to missile

Missile Radar
SAM Site

HARRIER JUMP JET

Evading Radar-Guided SAMs

Running Away

The basic method to evade radar-guided SAMs is to disappear from the radar. The further you are from enemy radar, the weaker the signal, so you may want to run away for a while until the signal is too weak to see you.

Auto Defence

Your ECM jammer is a good defence against beam riders.

Chaff

Each chaff cartridge (you have a maximum of 20 on board on each mission) sends out small tin-foil strips that reflect enemy radar. For a minimum of two seconds, the strips form a huge radar reflector, blinding the missile and acting like a smoke screen.

To employ chaff you must wait until the radar-guided missile is a few seconds away, then fire a cartridge (Key C) and turn away. The temporarily blinded missile will fly straight into the chaff missing you. Beware when using chaff because it may not deceive a Doppler-guided missile such as the SA-10 and SA-12 (see later).

Manoeuvring

It's important to manoeuvre out of the missile's field of view because, after your defence measure expires, the missile will re-acquire you and continue on a collision course!

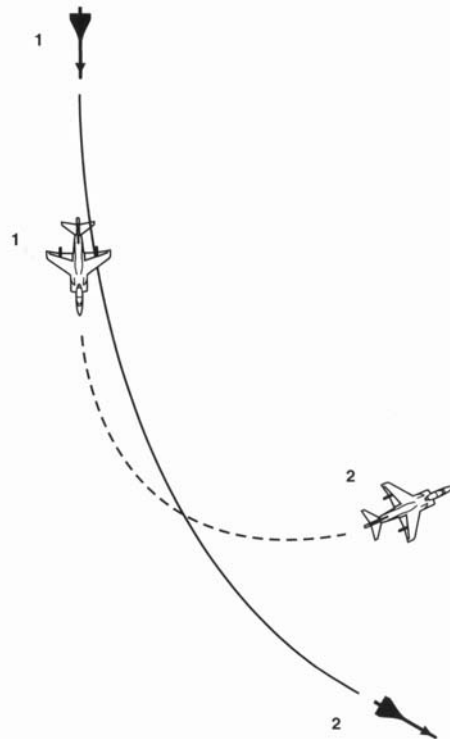
Infra Red Homing SAMs

Short ranged SAMs are usually IR homing that use a three-stage technique:

Search

The enemy detects your aircraft, from search radar, radio stations or by eyesight.

Turning inside a missile



Here your Harrier turns so tightly the missile can't "stay with you" and passes harmlessly off to the right. This is a common tactic for evading IR homing missiles.

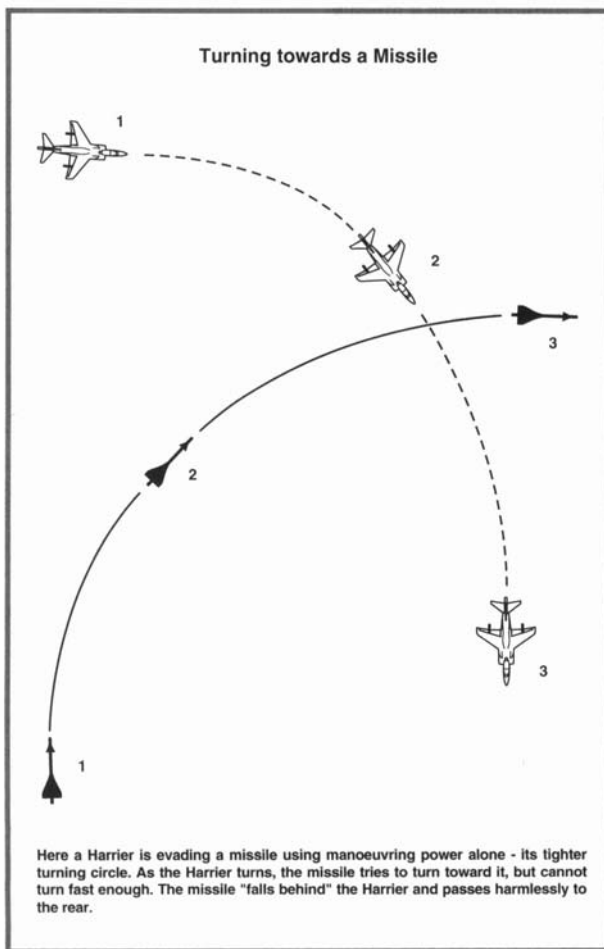
Missile Lock-On

A Missile is aimed at your aircraft. If you are close enough, the missile will see your heat signature and 'lock-on'.

Missile Launch

Once 'locked-on', the missile is launched and guides itself toward you.

Some SAMs are shoulder-launched; carried in trucks or jeeps by infantrymen and fired at point-blank range. If there are significant numbers of enemy forces you can expect these weapons.



Evading SAMs

Turning Away

First generation IR missiles can be outmanoeuvred by turning tightly towards them. This turns your hot exhaust from the missile's view. Second generation IR homers are more sensitive and recognize all surfaces heated by air friction, this means the front and top of a plane will appear 'hot'.

Flares

Flares are small, finely tuned heat decoys. A flare lures an IR missile toward it and away from you but only during the two to three seconds it takes to burn. After it has died, the missile will continue to seek, so the classic technique adopted by combat pilots is to wait until the missile is close then drop a flare and turn away.

Outmanoeuvring a Missile

SAMs can only find their targets within the acquisition arc of their seeker. The arc is 45° ahead of the missile. Move outside this arc, usually at 90° to its flight path, and you evade attack. You can also try turning inside a missile. Its turning arc is greater than yours causing it to zoom past you. Also, try turning toward a missile and increase turn tightness as it comes closer. The missile will not turn with you, but it will gradually fall behind and zoom past your tail.



HARRIER JUMP JET

If a SAM approaches you from the front, make a quick 90° turn forcing the missile to face the side of your aircraft. Now, roll 180° and turn toward the missile ready for a turning match.

Missiles with the Doppler-guidance systems are a special danger because they will not home-in on the chaff unless your course is perpendicular to the missile. If the missile chases you from the rear or straight ahead, chaff will have no effect. Three SAMs have Doppler guidance systems: SA-10, SA-12 and SA-N-6.

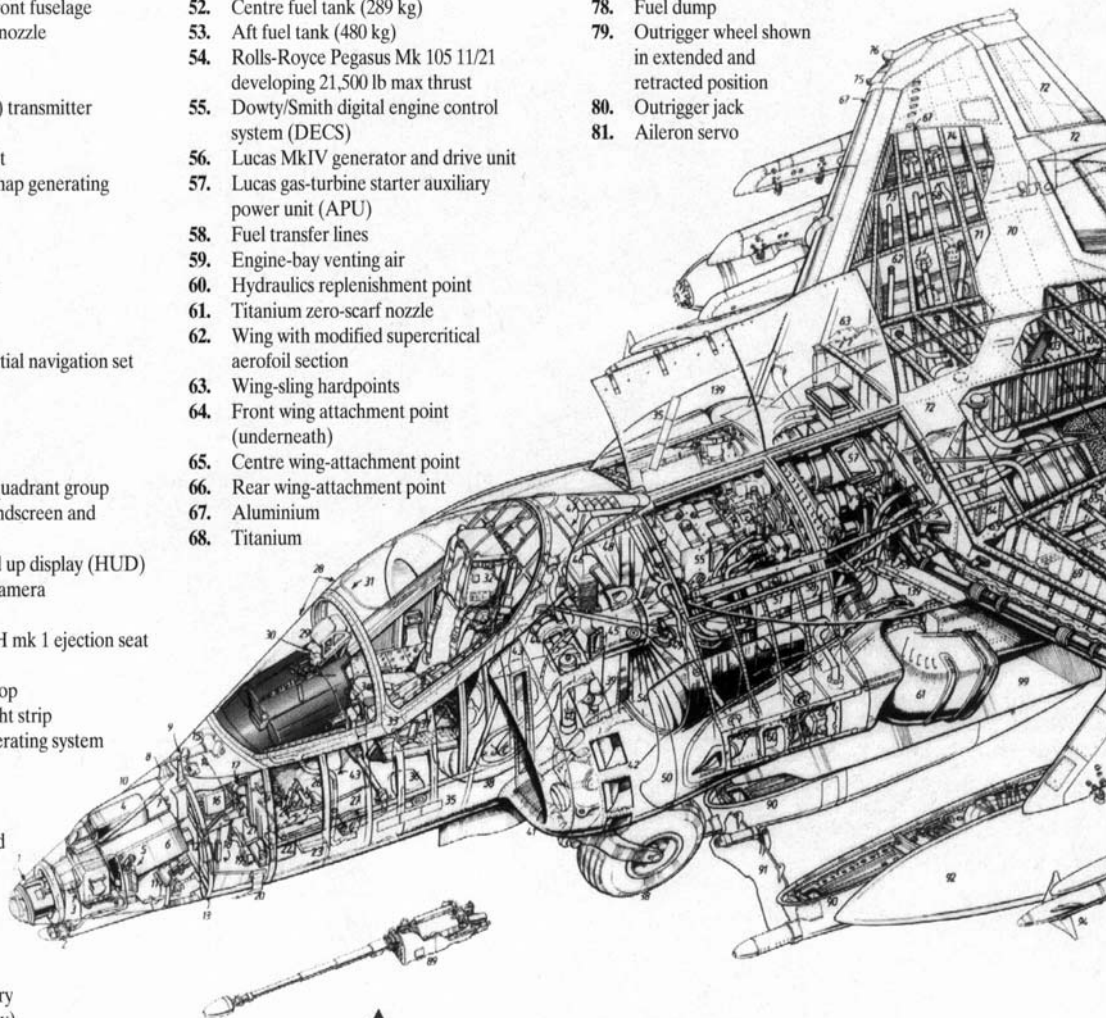




SECTION

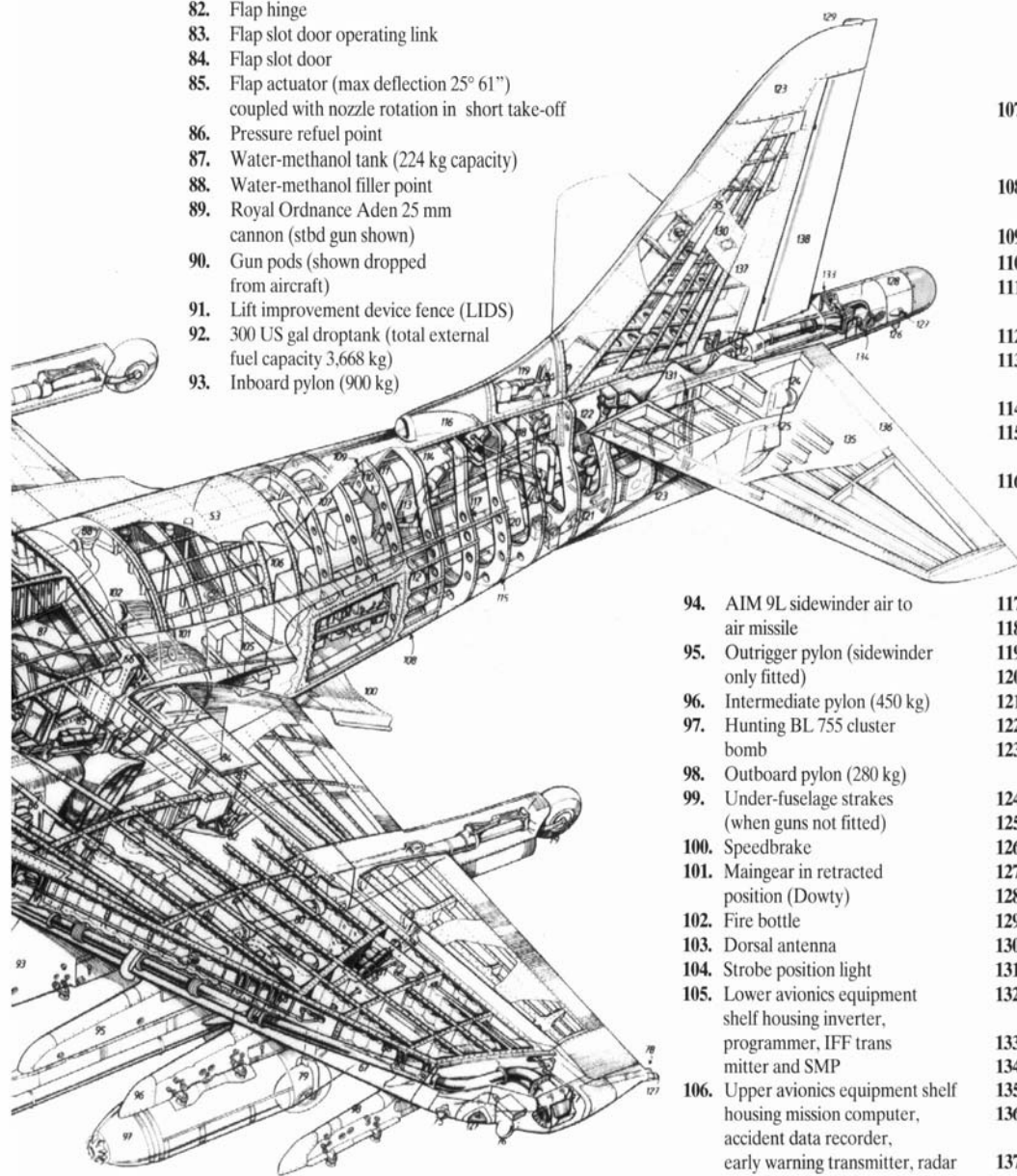
4

1. Hughes angle rate bombing set (ARBS)
2. Electronic warfare system antenna
3. ARBS equipment
4. GEC Sensors FLIR
5. Electronic warfare system (EWS) transformer
6. FLIR processor
7. EWS Transmitter
8. Upper IFF antenna
9. Yaw sensor vane
10. Composite structure front fuselage
11. Pitch reaction-control nozzle
12. Pitch trim servo
13. Pressure Bulkhead
14. Angle of attack (AoA) transmitter (starboard side)
15. Cold ram-air to cockpit
16. GEC Avionics video map generating system
17. Pitch 'Q' feel jack
18. Pitch spring-feel unit
19. Pilot/static equipment
20. Pitot head
21. Air data computer
22. Ferranti FIN 1075 inertial navigation set
23. Forward relay panel
24. Rudder pedal shaker
25. Essential CB panel
26. Rudder pedals
27. Rudder and elevator quadrant group
28. Svedlow Industries windscreen and canopy
29. Smiths Industries head up display (HUD)
30. Ferranti HUD video camera
31. Mild detonating cord
32. Martin-Baker type 12H mk 1 ejection seat
33. Nozzle-selector lever
34. Control column stick top
35. Formation-keeping light strip
36. On-board oxygen generating system (OBOGS)
37. Throttle control
38. Nosegear shown in retracted and extended positions (Dowty)
39. Retraction jack for nosegear
40. Hydraulics in nosegear bay
41. Increased inlet recovery (better cruise efficiency)
42. Auxiliary inlet doors
43. Conditioned air to cockpit
44. Cold-air unit
45. Ram-air exhaust
46. Cockpit air-system pack-heat exchanger
47. Heat exchanger ram-air
48. Bleed air to air-conditioning systems
49. Aileron control run
50. Forward fuel tank (480 kg)
51. Oil tank
52. Centre fuel tank (289 kg)
53. Aft fuel tank (480 kg)
54. Rolls-Royce Pegasus Mk 105 11/21 developing 21,500 lb max thrust
55. Dowty/Smith digital engine control system (DECS)
56. Lucas MkIV generator and drive unit
57. Lucas gas-turbine starter auxiliary power unit (APU)
58. Fuel transfer lines
59. Engine-bay venting air
60. Hydraulics replenishment point
61. Titanium zero-scarf nozzle
62. Wing with modified supercritical aerofoil section
63. Wing-sling hardpoints
64. Front wing attachment point (underneath)
65. Centre wing-attachment point
66. Rear wing-attachment point
67. Aluminium
68. Titanium
69. Composite sine-wave spar web
70. One-piece wingskins, upper skin removable for access
71. Graphite-epoxy woven cloth
72. Graphite-epoxy unidirectional bond
73. Wing tank (2,151 kg)
74. Wing-tank end rib
75. EWS antenna
76. EWS antenna
77. Roll reaction-control nozzle
78. Fuel dump
79. Outrigger wheel shown in extended and retracted position
80. Outrigger jack
81. Aileron servo



HARRIER JUMP JET

- 82. Flap hinge
- 83. Flap slot door operating link
- 84. Flap slot door
- 85. Flap actuator (max deflection 25° 61") coupled with nozzle rotation in short take-off
- 86. Pressure refuel point
- 87. Water-methanol tank (224 kg capacity)
- 88. Water-methanol filler point
- 89. Royal Ordnance Aden 25 mm cannon (stbd gun shown)
- 90. Gun pods (shown dropped from aircraft)
- 91. Lift improvement device fence (LIDS)
- 92. 300 US gal droptank (total external fuel capacity 3,668 kg)
- 93. Inboard pylon (900 kg)



- 94. AIM 9L sidewinder air to air missile
- 95. Outrigger pylon (sidewinder only fitted)
- 96. Intermediate pylon (450 kg)
- 97. Hunting BL 755 cluster bomb
- 98. Outboard pylon (280 kg)
- 99. Under-fuselage strakes (when guns not fitted)
- 100. Speedbrake
- 101. Main gear in retracted position (Dowty)
- 102. Fire bottle
- 103. Dorsal antenna
- 104. Strobe position light
- 105. Lower avionics equipment shelf housing inverter, programmer, IFF transmitter and SMP
- 106. Upper avionics equipment shelf housing mission computer, accident data recorder, early warning transmitter, radar altimeter, CNI data converter, receiver and transmitters (2) for GEC avionics AD 3500, VSDU, techniques generator, SAAHS computer and Aden gun interface unit
- 107. Top avionics equipment shelf housing EWS data processor, and EWS receiver
- 108. Flare dispensers situated behind speedbrake on lower fuselage
- 109. External power monitor
- 110. APU protection unit
- 111. Standby transformer/rectifier unit (TRU)
- 112. Main TRU
- 113. Conditioned-air delivery to equipment racks
- 114. Electrical distribution panel
- 115. Chemically milled side fuselage panels
- 116. Equipment-cooling pack heat exchanger
- 117. Reaction control air duct
- 118. Rudder cable tensioner
- 119. Rudder power-control servo
- 120. Generator panel
- 121. Elevator control runs
- 122. Elevator control servo
- 123. Broadband communication and nav antennas
- 124. EWS antenna
- 125. EWS antenna
- 126. IFF antenna
- 127. Navigation lights
- 128. Aft radome
- 129. Radar beacon antenna APM-202
- 130. MAD compensator
- 131. Tailplane hinge
- 132. Linkage from tailplane to pitch control nozzle
- 133. Yaw reaction-control nozzle
- 134. Pitch reaction-control nozzle
- 135. Bonded tailplane structure
- 136. Detachable composite trailing edge on tailplane
- 137. Aluminium alloy 3-spar fin
- 138. Composite rudder
- 139. Leading edge root extensions



THE
HARRIERS

HARRIER JUMP JET

THE HARRIERS

The GR Mk.7

An upgrade of the GR Mk.5 incorporating Forward Looking Infra Red (FLIR) equipment and cockpit modifications for Night Vision Goggle compatibility. The GR Mk.7 can fly and deliver ordnance accurately at night, in bad weather conditions and at low-level.

Specification**TYPE**

Single-seat STOVL (short take-off vertical landing) tactical ground-attack fighter

POWERPLANT

One Rolls-Royce Pegasus 11-21 (Mk 105) vectored thrust turbofan rated at 21,750lb static thrust (st)

DIMENSIONS

| | |
|-----------------------|--------------------------------------------|
| Wingspan: | 30ft 4in (9.25m) |
| Overall length: | 46ft 4in (14.2m) |
| Height: | 11ft 8in (3.55m) |
| Wing area (inc LERX): | 239sq ft (22.2sq m) |
| Wheeltrack: | 17ft (5.18m) |
| Wheelbase: | 11ft 4in (3.45m) (nosewheel to mainwheels) |

WEIGHTS

| | |
|-----------------------------------------|---------------------|
| Empty weight: | 14,300lb (6,485kg) |
| Max conventional take-off (CTO) weight: | 31,000lb (14,060kg) |
| Max vertical take-off (VTO) weight: | 18,950lb (8,595kg) |
| Max fuel/weapon load (CTO): | 17,000lb (7,710kg) |
| Max fuel/weapon load (VTO): | 6,750lb (3,062kg) |
| Max vertical landing weight: | 18,650lb (8,459kg) |

PERFORMANCE

| | |
|---------------------------------------------------------------|--------------------------|
| Max Mach no. at high level: | Mach 0.91 |
| Max speed at sea level: | 662mph (1065kph/575kts) |
| Combat radius (air-to-ground mission): | 480nm (553 miles/889km) |
| High-level intercept radius (3min combat reserves for VL): | 627nm (722miles/1,162km) |

ARMAMENT

Two 25mm ADEN cannon with 100 rpg; two AIM-9L Sidewinder AAMs; up to 9,200lb of external ordnance (see below)

CONSTRUCTION MATERIALS

| | |
|-------------------------|-------|
| Metallics: | 70% |
| Carbon fibre composite: | 25% |
| Acrylic: | 1.75% |
| Fibreglass: | 0.25% |
| Other: | 3% |

The Pegasus Engine

The 24,450lb st Rolls-Royce Pegasus Mk 105 remains the world's only production vectored thrust turbofan and is unique to the Harrier, providing both lift and propulsive thrust for the RAF's entire fleet of Harrier GR5 and GR7 aircraft. Known also to the USMC as the Pegasus 11-21E or the F402-RR-406A, the engine represents a substantial improvement over the Mk 103 which powered the GR5/7's predecessor the GR3. With particular regard to its reliability and maintenance: time between overhauls (TBO) is now 1,000 hours compared with a mere 30 hours in 1960 for the very first Pegasus Mk 3. This is an important consideration if the aircraft is operating away from its home base in forward positions where engineering back-up may be limited.

The Pegasus Mk 105 is also fitted with a Digital Engine Control System (DECS) which monitors the performance of the power plant at all times, automatically adjusting the thrust settings whilst taking into account the aircraft's speed and altitude within the performance limitations imposed by engine rpm, jet pipe temperature and acceleration. The DECS takes much of the pressure off the pilot who previously had to monitor all these functions, fly and fight at the same time. A rapid thrust-dumping mode also prevents pilots from 'bouncing' the aircraft on vertical landings - saving a loss of face in the crew room afterwards!

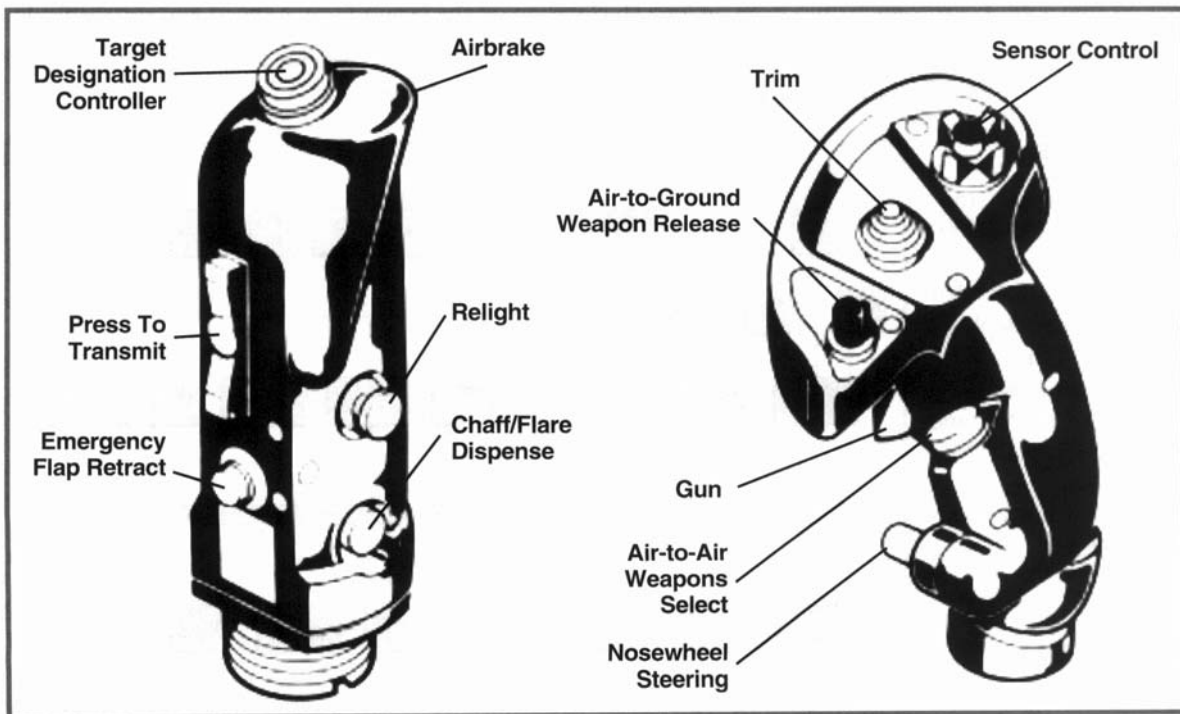
HARRIER JUMP JET

Inside the Cockpit

Representing a huge improvement over the GR3, the GR7 cockpit is roomy and less cluttered, with more attention paid to ergonomics by the manufacturers. The pilot's Martin-Baker Type 12 ejection seat is fitted higher in the cockpit than in the older aircraft, giving him a higher eyeline and a greater field of vision through a new bulbous canopy.

The Smiths Industries 425SUM1 head-up display (HUD) and its associated up-front control (UFC) push-buttons below, together with the TV-type multi-purpose display (MPD) screen on the main instrument panel to the pilot's left, offer him a number of display modes which include navigation, stores management, weapons delivery, engine/fuel data and radar warning.

A GEC Avionics Digital Colour Map Unit (DCMU) viewed on a Smiths Industries MPD is on the main instrument panel to the pilot's right, and receives computer data from the Litton AN/ASN-130 inertial navigation system (INS) (also fitted to the USMC AV-8B) situated beneath the pilot's feet. The right-hand MPD also acts as a standby, or alternative, to the MPD fitted to the left-hand side of the main instrument panel.



Hands-On-Throttle-And-Stick (HOTAS) allows the pilot to control all combat functions without removing his hands from the stick.

There are fewer dials in the new cockpit and are confined to conventional analogue flight instruments such as altimeter, airspeed indicator (ASI), angle-of-attack (AOA), compass with course/heading/distance etc, and clock. They are situated centrally immediately behind the HOTAS (hands-on-throttle-and-stick) type control grip.

HOTAS allows the pilot to control virtually all the functions required in a combat situation without removing his hands from the stick such as weapons, manoeuvre flaps, ARBS and Sidewinder selection.

The consoles on either side of the pilot contain (to the left) throttle and jet nozzle actuator lever; fuel, external lighting (navigation, landing, anti-collision) and oxygen switches; the SAAHS (Stability Augmentation and Attitude Hold System) panel. To the right are the communications, cockpit environment and power supply switches.

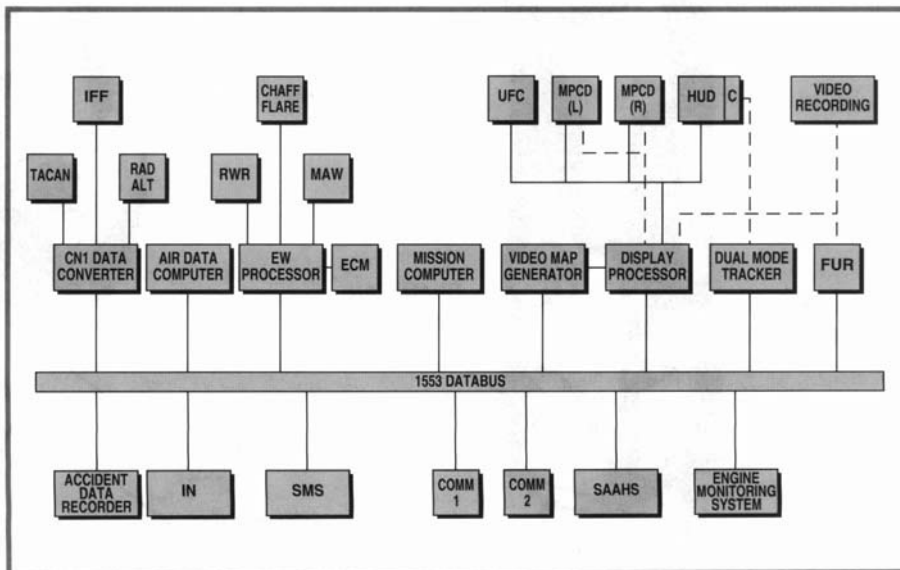
The SAAHS provides automatic stabilisation throughout the aircraft's flight envelope and also acts as an autopilot during take-off, landing and transition, with automatic altitude, attitude and heading hold essential during the low-speed manoeuvres crucial to the operation of STOVL aircraft.

A Martin-Baker Type 12 ejection seat is fitted to the GR7. It is known as a "zero-zero" system which means that a pilot can "punch out" from an aircraft standing on the ground - zero speed and zero altitude.

Life-support equipment carried in the GR7 cockpit includes full NBC warfare protection for the pilot and an on-board oxygen generation system with an oxygen/air mixture control.

Avionics

An ECM-resistant GEC Avionics AD3500 U/VHF transceiver is fitted to the GR7 for communications plus a Cossor IFF 4760 transponder. The Litton AN/ASN-130 INS and GEC Avionics DCMU act together as a terrain-reference navigation system.



GR.7 Avionics Schematic

HARRIER JUMP JET

The transparent nose cone of the GR7 accommodates the Hughes ASB-19(V)-2 Angle Rate Bombing System (ARBS) which has two basic modes. As a laser spot tracker it enables the pilot to visually acquire his target while it is being illuminated by a ground-based laser source or a designator-equipped aircraft. This mode does not need to be used in daylight attacks when contrast lock (the target's natural contrast characteristics) can be employed. In its TV mode, the ARBS projects target angle rate data (slant angle and range to the target) onto the HUD and the pilot follows the steering instructions to ensure an accurate weapons delivery in a single pass.

Electronic Countermeasures

The Tracor AN/ALE-40 chaff/flare dispensers located beneath the wings in the undercarriage outrigger fairings are activated by the Marconi 'Zeus' ECM system from twin antennae beneath the nose housing forward hemisphere receivers. It is likely that a Philips chaff/flare dispenser mounted inside the Sidewinder pylon will eventually be fitted to augment the existing equipment.

'Zeus' consists of an advanced radar-warning receiver (RWR) combined with an automatic Northrop jammer which is capable of responding, via its computer memory of up to 1,000 known emitters, to confuse any would-be attacker. It can also automatically trigger decoy chaff and flares to combat radar-guided and heat-seeking missiles respectively.

In the extreme tail of the aircraft a small radome houses the Plessey Missile Approach Warning (MAW) system which can automatically activate appropriate countermeasures when it detects a hostile missile homing in. Beneath this radome in the ventral fin tail bumper is an ECM/Rear Warning Radar (RWR) and in each wing tip more 'Zeus' ECM antennae, plus transmitter aerials for the jamming component.

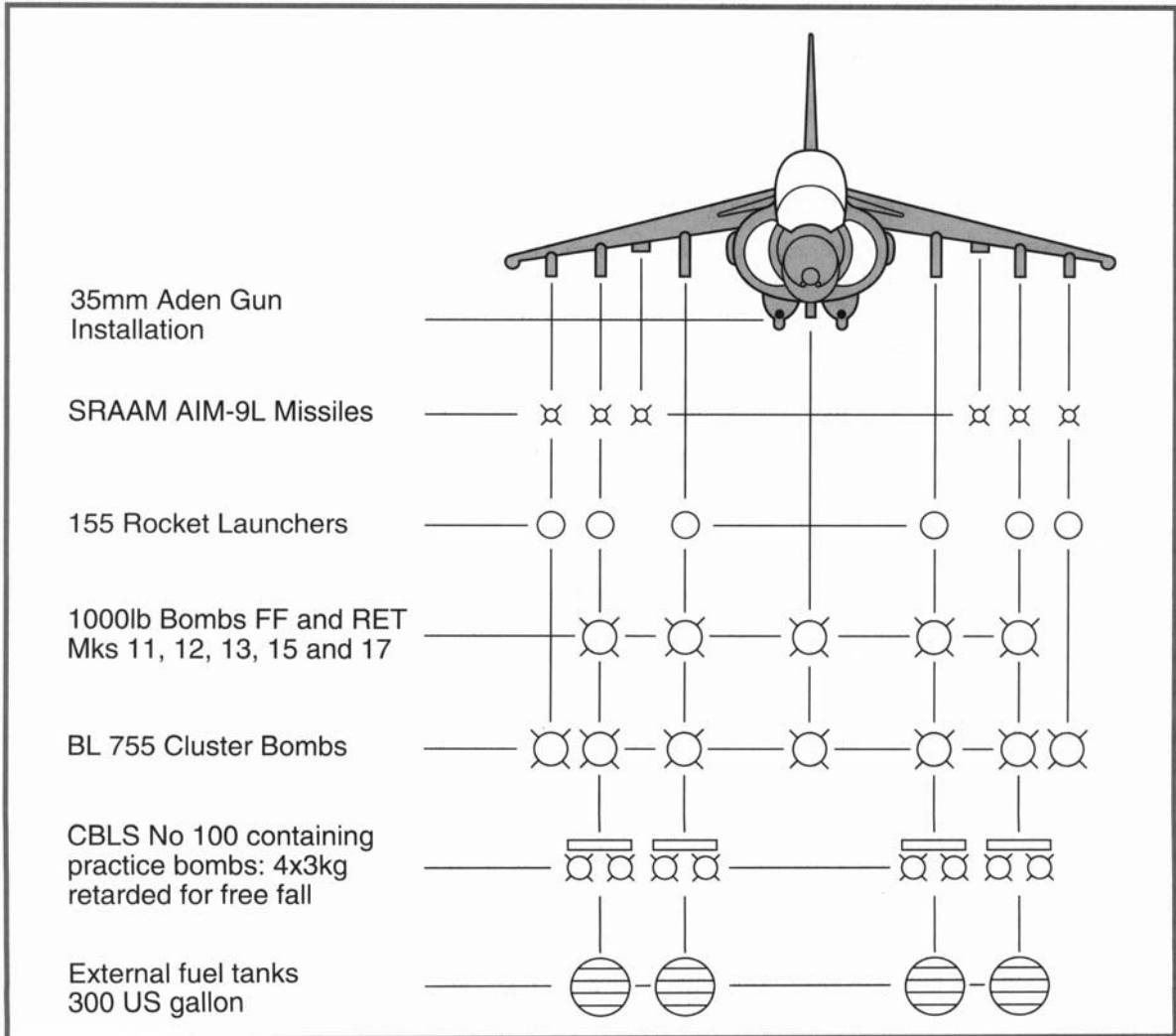
Night Operations

Although the Harrier GR7 is by no means an all-weather day/night aircraft, the combination of a forward looking infra red (FLIR) system and a pair of night vision goggles (NVG) for the pilot allows the aircraft to fly close-support missions at any time of the day or night, except in the very worst of weather conditions.

FLIR is a form of thermal imaging equipment which detects temperature differences in and around the object under surveillance. Put simply, it is a heat-sensitive camera which sees shape in terms of heat rather than reflected light. The GEC FLIR equipment is mounted in a slim, raised fairing on top of the aircraft's nose cone but its field of vision is fairly narrow, confined as it is to dead ahead, so the pilot must have a means to intensify his peripheral vision during night operations. This is achieved by the use of a pair of Ferranti NITE-OP (Night Imaging Through Electro Optics Package) night-vision goggles fitted to the pilot's bone dome which are not unlike a pair of binoculars in appearance. They are basically a clever optical device which widens his field of vision in the dark by converting any incoming (optical) light into electrons which are then electronically enhanced and converted back to optical light (photons) as a brighter, clearer image in the eyepieces of the goggles. This enables him to view the air and ground ahead

and to either side in sufficient detail so he can keep an eye open for 'bogeys' and to navigate and locate his target. The GR7's cockpit is night-goggle-compatible (NGC) which means that instrumentation and lighting have been modified to compensate for the effects of the pilot viewing instrumentation through his NVGs.

Weapons and Stores



HARRIER JUMP JET

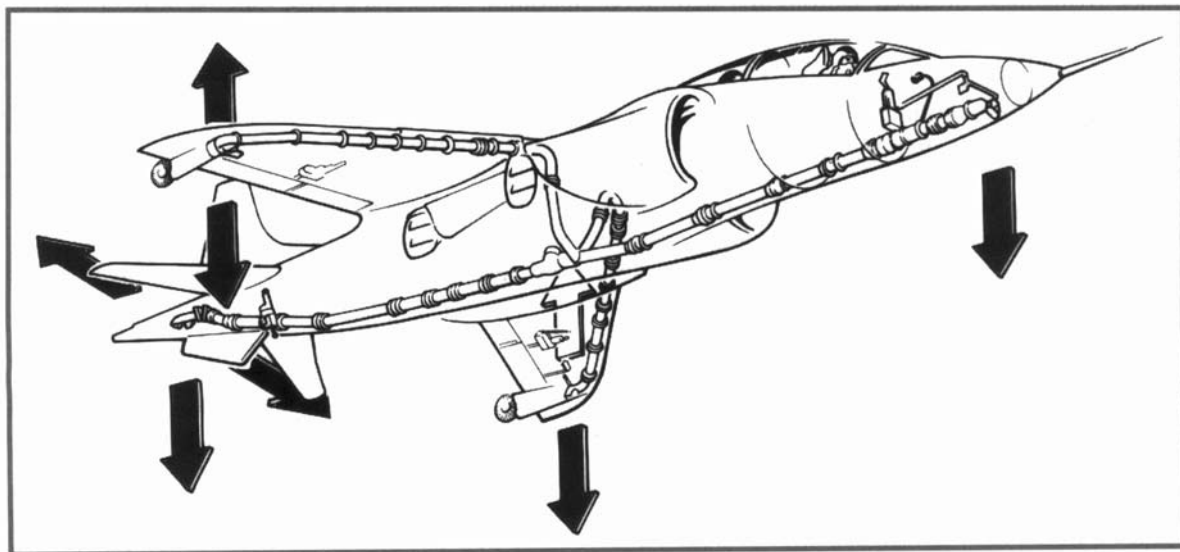
There are nine stations on the GR7 for the attachment of weapons and stores: four below each wing and one centreline point beneath the fuselage, plus two underbelly cannon pods. The precise mix of fuel and weapons to be carried is dictated by the distance to the target, although the GR7 has about 14,500 lb of weight available for fuel and weapons of which some 9,200lb takes the form of external stores.

The range of weapons available to the GR7 includes the AIM-9L all-aspect Sidewinder air-to-air missile for self defence. Dedicated pylons are located between the inner and intermediate stations beneath each wing, aligned with the outrigger undercarriage fairing for the carriage of two missiles. Up to six Sidewinders can be carried by RAF GR7s.

A wide selection of stores is available to the GR7 including the Hunting BL755 582lb (264kg) cluster bomb for use against armoured vehicles; 540lb and 1,000lb (245 and 454kg) high explosive bombs (free-fall or with tail-mounted retarding parachute); laser-guided 1,210lb (549kg) Pave Way bomb; Matra 155 rocket pods carrying 18 x 68mm SNEB rockets for anti-shipping attacks; and two 25mm ADEN cannon with a rate of fire of between 1,650 and 1,850 rpm. The inner and intermediate pylons are also plumbed for fuel and the fitting of drop tanks.

Reaction Control System

In normal flight, the Harrier is controlled by ailerons, rudder and an all-moving tailplane. The aileron and tailplane are power operated and are fed by two independent hydraulic systems. The rudder is pilot powered. However, in hover or minimal jet flight - which takes place below normal aerodynamic stalling speed- normal controls are not sufficient and have to be backed up by the Reaction Control System.



The Reaction Control System

The system controls the aircraft in roll, pitch and yaw and is linked to the Harrier's rudder pedals and control column. This means that, even in hover, the pilot can fly the Harrier like any normal aircraft, giving him important continuity of control.

RCS is based around the engine high-pressure compressor bleed-air fed to the shutter valves positioned at the extreme points of the aircraft. The valves are ordinary convergent nozzles with a varying exit area created by a swinging shutter. These shutters on the Reaction Control Valves are driven by the flying control system.

Landing Performance

The Harrier's flap/aileron/nozzle high lift system allows slower approach speeds and more reserve power, leading to a greater thrust margin, less water consumption, reduced wear and tear on the engine and a shorter ground roll.

Structure

The Harrier is the first normal production combat aircraft to have been constructed out of a high percentage of composite materials. Composite material is used to make up the wings, forward fuselage, stabilator, ailerons, flaps, rudder and access doors creating a saving in weight of 480 pounds (217 kg).

The Wing and LERX

The Harrier wing is a supercritical airfoil which holds a large quantity of fuel. The wings have automatic-manoeuvring flaps, drooped ailerons in a high-lift configuration and leading edge root extension (LERX) for increased agility in flight.

Developed by British Aerospace LERX are aerodynamic surfaces in front of the wing root which increase pitch rate and lift, leading to improved turn rate and handling at high angles of attack. LERX work by producing a vortex, an energetic tube of rotating air, along the top surface of the wing. As the incidence angle of the wing is increased (if the aircraft is flown in a tightening turn), the airflow over it becomes untidy and disturbed, starting at the tips and moving inward. Without LERX this untidy flow would extend across the whole wingspan, the wing would stall and the aircraft would fall out of the turn. The vortex from the LERX allows the airflow to remain stable, so a higher angle of incidence can be reached, and a tighter turn can be flown.

Electrical Systems

Power is produced by a single engine-driven generator. AC is converted to DC via two transformer rectifier units (TRU) with a battery unit which is used to start the Auxiliary Power Unit (APU).

HARRIER JUMP JET

GTS/APU

A Gas Turbine Starter and Auxiliary Power Unit is located on top of the Pegasus and is used to start the engine and provide AC electric power at times when it is not running. It may also be used as a standby generator if the main generator fails.

Fibre Optic Technology

The Harrier is unique in its use of fibre optics (thin glass threads) to transmit light impulses instead of electrical impulses. These optics can transmit the information of a complete set of encyclopaedias in under 16 seconds.

Systems

The Harrier has an integrated, computer-controlled navigation and attack system. System components are interconnected by a MIL-STD-1553B dual-redundant multiplex digital databus providing a high integrity, high reliability data link. The central control of the mission computer gives information to the pilot via HUD, MFD and ODU (Options Display Unit). The mission computer also controls the moving map display (MMD) which is in itself controlled by an operational flight program.

Backup systems are available, in event of failure, including sub-systems with secondary control panels for weapons and communications.

Inertial Navigational System (INS)

An automatic, self-contained dead-reckoning system. The mission computer uses information to calculate velocity, pitch, roll and true heading which it then passes to other systems.

Current position is worked out on a continuous basis from inertial inputs and keeps to an accuracy of level of 1 Nautical Mile per hour. Position can be updated using either TACAN fixing, geographical point recognition, or through the Moving Map Display.

The main unit of this system is the Ferranti F.E. 541 inertial platform used in conjunction with a HUD developed by Specto Avionics and the Smith's Air Data Computer.

Moving Map Display

Known to the pilots as the 'shufti scope', the MMD shows a map area in either track or north orientation. The INS can be aligned wherever the aircraft is 'parked' by punching in latitude and longitude coordinates correct to two decimal points. To ensure 100% attack accuracy, three check points are fed in leading up to the target. When the Harrier reaches a particular check point, small errors in navigation are corrected.

Stores Management System

Controlled through the UFC, MPD and HOTAS controls, this system controls the delivery of air-to-ground weapons, Sidewinder missiles and the two Aden guns mounted in fuselage.

Angle Rate Bombing Set (ARBS)

Pinpoints targets with laser/TV contrast tracking which enables high-accuracy first pass attacks. In effect, once the pilot has 'locked-on' to a target using the passive non-radiating ARBS tracker, line-of-sight and angle rate information is input to the computer which takes care of steering commands on all head-up/head-down displays.

The TV-contrast tracker provides a six times magnification of the target on the multi-function display (MFD) and is linked to the laser spot tracker and AIM-9 seeker head as extra target identification information.

The pilot can release weapons manually with Continuously Computed Impact Point (CCIP) system or choose automatic ordnance release mode. In laser-guided attacks the target is highlighted by a laser designator (airborne or ground based) and once the ARBS Laser Spot Tracker 'locks' onto the target steering data is output by the computer. Laser designation can spot most targets by day or night.

Survivability

If battle damage is incurred the Harrier incorporates many features to help survivability including redundant fuel and hydraulic systems, a multi-spar composite wing and mechanical/fluid control systems which can operate without electric power. The risk of fire is reduced by the On-Board Oxygen Generation System (OBOGS) which makes the carriage of liquid or gaseous oxygen redundant.

Fuel System

Five fuselage and two integral wing tanks give a capacity for 7500 pounds of fuel. In addition, the Harrier can carry four external fuel tanks on underwing pylons increasing capacity to 15,520 pounds.

The fuel system is organized in two separate sections: fuel is channelled to the centre tank and then to the engine-driven pump and the Digital Engine Control System (DECS). In event of the failure of one section, the other section will still feed the engine.

Refuelling is carried out under high pressure through a single coupling on the left forward fuselage. In-flight refuelling is made possible by a retractable probe mounted on the left inlet.

Pressurisation and Air Conditioning

The engine HP compressor air provides two pressurisation/air conditioning systems incorporating cold air units. One system provides cockpit air and ventilates equipment in the nose. The second provides air to the rear equipment bay.

HARRIER JUMP JET

Oxygen System

The On-Board Oxygen Generating System (OBOGS) supplies the correct breathing mixture to the pilot when the engine is operating. The ejection seat also contains an emergency supply of breathing oxygen which can be worked automatically or manually.

Anti-g System

The air supply system also provides the pressure for the pilot's anti-g suit, channelled with his oxygen (and a mic/tel connector) through a seat mounted Personal Equipment Connector (PEC). This means that the whole four-function unit can be connected and disconnected with one rapid action.

Hydraulic System

Two independent systems produce hydraulic power that can operate the flight controls in the event of system failure. Dual engine-driven pumps provide 3000 PSI pressure to feed the system.

Escape System

The Harrier has a fully automatic Martin-Baker type 12H Mk.1 rocket-assisted ejection seat with the zero-zero specification. This allows escape at all altitudes and speeds in the aircraft flight envelope down to zero height/zero speed.

The Martin-Baker has small sensors to measure altitude, airspeed and deceleration after ejection. A selector then gathers the data to adjust operation for low speed/low altitude, high speed/high altitude or any speed/high altitude ejection. Immediately prior to ejection, the canopy is broken by a tiny detonating cord system fired automatically by the movement of the ejection seat.

The AV-8B



HARRIER JUMP JET



The AV-8B's main task is to provide close air support for ground troops but has proved to be extremely useful in many other tactical roles. It is used by the United States Marine Corps who employ the aircraft's STO/VL capabilities for high sortie rates and rapid response times. The AV-8B, also known as the Harrier II, was developed by McDonnell Douglas in collaboration with British Aerospace.

AV-8B Harrier II Specification

TYPE

Single-seat STOVL tactical ground-attack fighter

POWERPLANT

One Rolls-Royce Pegasus F402-RR-408 (11-61) vectored thrust turbofan rated at 23,800lb st

DIMENSIONS/WEIGHTS /PERFORMANCE

As for the RAF's Harrier GR7

POTENTIAL ARMAMENT

216lb (98kg) LAU-68, 577lb (262kg) LAU-10 and 542lb (246kg) LAU-61 rocket launchers; AGM-65 Maverick missiles; 490lb (222kg) Mk 20 bombs, 520lb (236kg) Mk 77 fire-bombs, 270lb (122kg) Mk 81 bombs, 530lb (240kg) Mk 82 bombs, 985lb (447kg) Mk 83 bombs; AIM-9L Sidewinder AAMs on underwing pylons; and a single GAU-12/A 25mm cannon beneath the fuselage.

The Sea Harrier FRS1



Harriers taking off from an aircraft carrier ski-jump

Although this manual concentrates primarily on the RAF Harrier II GR7 and the US Marine Corps AV-8B, it is useful to take a quick look at its carrier-based maritime cousin the Sea Harrier FRS1 which fought with great distinction in the South Atlantic during the Falklands conflict of 1982. It is the only Harrier variant with a primary air-combat role.

Formulated by a Naval Staff Requirement for a sea-going version of the land based GR3, the Sea Harrier was supposed to be a minimum-change version of the GR3, but it did introduce a number of design and avionics changes (noted below) when it entered service with the Royal Navy in 1979-80. The type has since been superseded by the much updated FRS2 version.

HARRIER JUMP JET

Sea Harrier FRSI Specification

TYPE

Ship borne single-seat VSTOL strike fighter

POWERPLANT

One Rolls-Royce Pegasus 104 vectored-thrust turbofan rated at 21,500lb st

DIMENSIONS

| | |
|-----------------|-------------------------|
| Overall length: | 47ft 4in (14.5m) |
| Wingspan: | 25ft 3in (7.7m) |
| Overall height: | 12ft 2in (3.71m) |
| Wing area: | 201.1 sq ft (18.68sq m) |

WEIGHTS

| | |
|------------------------|---------------------|
| Empty weight: | 14,052lb (6,374kg) |
| Operational weight: | 23,000lb (10,433kg) |
| Max take-off weight: | 26,200lb (11,884kg) |
| Underwing load weight: | 5,000lb (2,268kg) |
| Fuel capacity: | 5,010lb (2,273kg) |

PERFORMANCE

| | |
|--------------------|-------------------------------------|
| Maximum speed: | 642kts (736mph/1,189kmh) |
| Cruising speed: | 485kts (898kmh) |
| Service ceiling: | 50,000ft (15,240m) |
| Radius of action: | 250nm (463km) |
| Maximum endurance: | 7.3 hours with one in-flight refuel |

ARMAMENT

2 x 30mm ADEN cannon in under-fuselage gun pack; 2/4 AIM-9L Sidewinder AAMs; 5 x 1,000lb (454kg) iron bombs (free-fall or retarded); 5 x 600lb (272kg); 2 x BAe Sea Eagle anti-shipping missiles; 4 x Matra 115/116 68mm rocket pods; 5 APAM/Rockeye Mk 7 cluster bombs; 10 x Bofors Lepus flares

Power plant

The Pegasus Mk 104 fitted in the Sea Harrier is a navalized version of the Mk 103 that powered the RAF's GR3, replacing aluminium with non-corrosive magnesium and other alloys to resist corrosion from the saline atmosphere of a carrier's deck.

Cockpit

To provide under floor space for avionics equipment and a revised cockpit layout, the cockpit floor of the Sea Harrier was raised by 11 inches. Quite coincidentally, this raising of the floor provided the pilot, who sits on a Martin-Baker Type 10H zero-zero rocket-type ejection seat, with much improved all-round visibility from the bubble canopy. The cockpit interior was redesigned to accommodate the Ferranti Blue Fox multi-mode radar and other naval-oriented avionics.

Blue Fox is an I-band pulse-modulated radar designed for air-to-air interception and air-to-surface search and strike. Fitted in the Sea Harrier's nose behind a pointed radome, it was developed from the Seaspray search radar specifically for single-pilot aircraft and has all the necessary flight information (speed, altitude, heading etc) superimposed on the TV-type daylight viewing display of the radar. Blue Fox operates in four modes: search, attack, boresight and transponder.

A Smiths Industries HUD driven by a 20,000-word digital computer generates display symbology and also acts as a flexible air-to-air and air-to-surface Weapons Aiming Computer (WAC).

The basic layout for the flying controls and instrumentation in the Sea Harrier FRS1 is similar to the land-based Harrier GR3, but with no moving map and a small radar display added on the right-hand side of the main panel.

Avionics

The Sea Harrier's electrical equipment differs from that of the land-based Harrier and its flying characteristics have been improved to complement its role as strike fighter. Increased roll reaction has been provided for dogfighting allowing a two-degree increase in nose-down pitch control.

A Ferranti self-aligning Heading and Attitude Reference System (HARS) platform, cross-referenced to a Decca 72 Doppler radar, performs all of the navigation and endurance functions required. It provides far greater accuracy than a normal INS and can be aligned on a moving deck. A UHF homing and a GEC Avionics AD2770 TACAN plus an I-band transponder are also used for navigation. Radio communications are handled by a Plessey PTR377 U/VHF transceiver with a D403M transceiver for standby VHF.



HARRIER JUMP JET

Electronic Countermeasures

Marconi ARI 18223 radar warning receiver aeriels are positioned on the fin leading edge and extreme tip of the tailcone to warn of illumination by hostile radar. A Tracor ALE-40 chaff/flare dispenser unit was fitted in the rear fuselage as an emergency update prior to embarking to the South Atlantic in 1982.

Weapons and Stores

The Sea Harrier FRS1's armament in its primary air-combat role is the all-aspect infra red homing AIM-9L Sidewinder missile. The lessons learned in the Falklands led to the fitting of twin-rail Sidewinder launchers beneath each wing.

A selection of bombs, cannon, depth charges, rocket pods and nuclear depth bombs can also be carried, thus making the Sea Harrier an extremely versatile fleet fighter. To extend the aircraft's combat or ferry range, a selection of drop (100 and 190 gallon) and ferry (300 gallon) tanks are available for carrying beneath the wings.



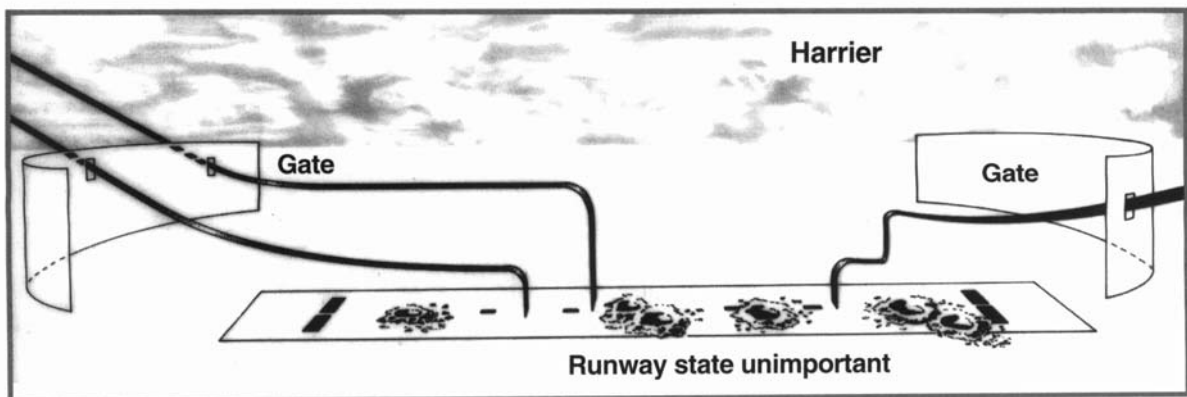
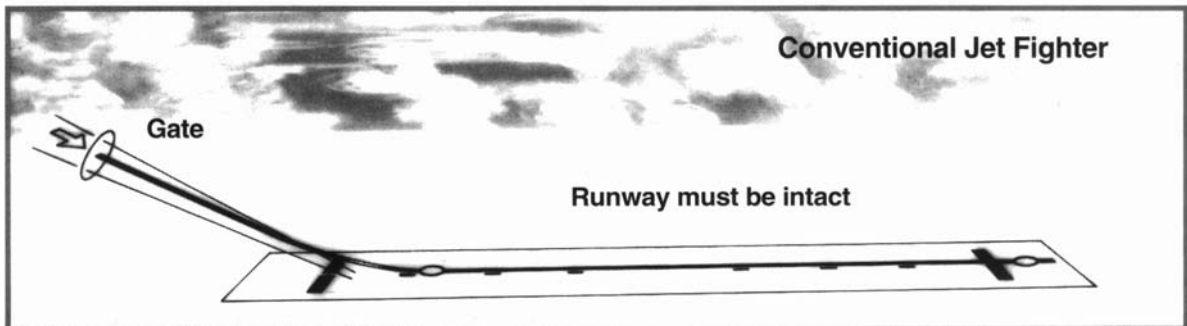
**OPERATING
FROM
DISPERSED
SITES**

HARRIER JUMP JET

OPERATING FROM DISPERSED SITES

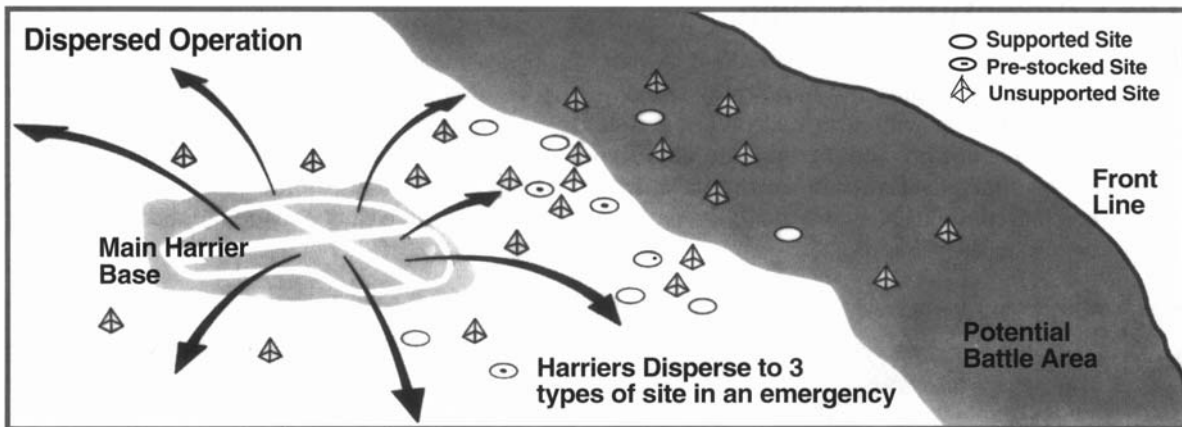
The Conventional Airfield

A modern military airfield cannot be hidden. A pair of runways measuring over 2000 metres in length, as well as hangars, taxi routes and hardstands, make it very visible and subsequently almost impossible to defend in modern war without a vast outlay in defensive equipment. Even then, missile attacks will be very difficult to neutralize and the best anti-aircraft defences will not prevent the runway from sustaining some kind of damage. If aircraft on the base do survive an attack they cannot be effective until the runway is repaired. It has been proved in the past that an entire air force can be made redundant if caught in this manner on the ground.



The Concept of Dispersed Operation

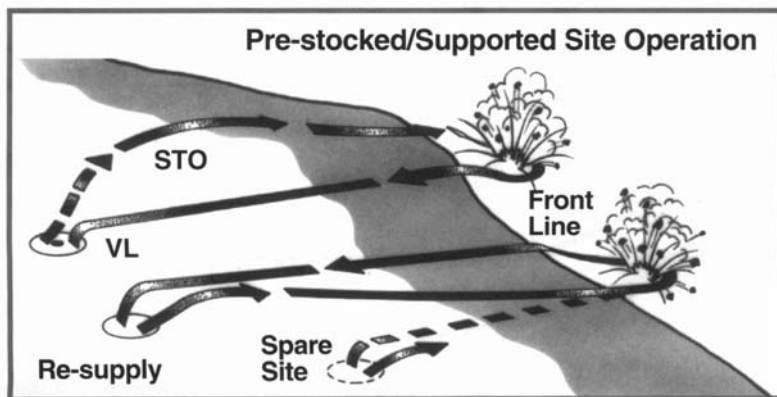
In a 'hot' war, the continued existence of conventional aircraft and the airfields and runways from which they operate would be questionable. A well-placed bomb in the centre of a runway and on the Hardened Aircraft Shelters (HAS) could quite easily stop operations indefinitely for a squadron of multi-million pound high performance jet aircraft.



The coming of the Harrier has revolutionized traditional military planning with its ability to operate away from home base out of rough forward airstrips, woodland clearings, motorways or carparks close to the battlefield. Basically, it can escape from the prying eyes of the enemy and from the in-built vulnerability of permanent airfields.

The Site

The Harrier can be dispersed across a wide range of terrain. All that is necessary are a few hundred feet of open ground. These in-the-field sites can be pre-stocked, or may merely act as launch platforms for Harriers originating from a main base ready-fuelled and armed. With Harriers, there is little need for ground support equipment.



HARRIER JUMP JET

The Main Base

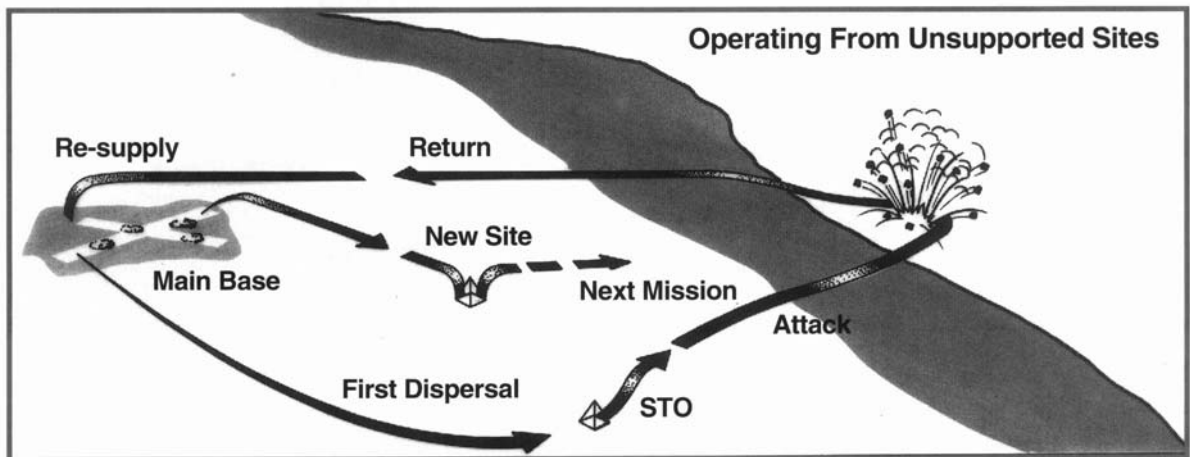
Damage to the main base airfield of a Harrier squadron is not critical. A Harrier will still continue to operate from a seemingly shattered runway. It can easily perform short take-off in the space left between bomb craters.

Detection by an Enemy

The enemy will find it very difficult to detect a dispersed Harrier force and will have to carry out area reconnaissance; tying up a large number of aircraft. It's obvious that a dispersed Harrier force has a good chance of remaining undetected. Dispersed sites have the added advantage of needing no ground-to-air defences.

Operating in Undeveloped Zones

The Harrier also has the advantage of operating in parts of the world where modern airfields are few and far between. Most undeveloped countries rely on light air transport and have a plethora of small dirt track airstrips that could not support modern jet fighters but are more than ideal for Harrier operations. The Harrier is unique in its ability to operate in such situations.

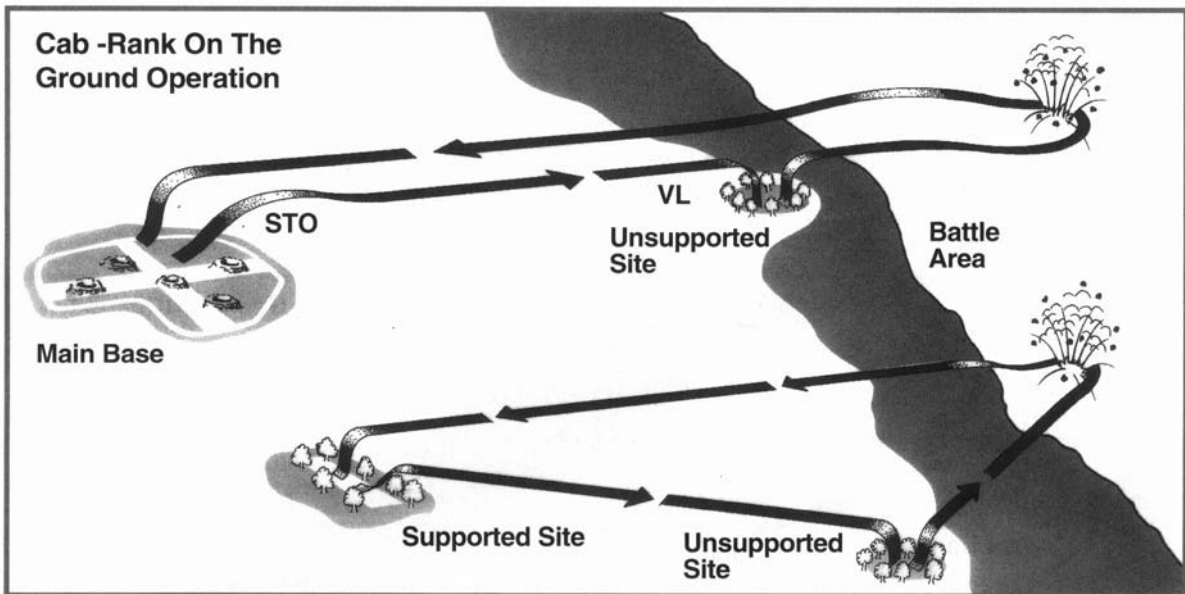


System of Operation

The difference between the Harrier and conventional military aircraft is clear cut. While a normal jet fighter will fly from a distant airfield, a long way from the combat zone giving it a slower speed of response, the Harrier flies short-duration missions, carrying moderate loads but with the possibility of rapid turnaround.

The Harrier can arrive at the target a few minutes after take off, giving a tactical advantage to the ground troops. This can be compared to the hour or so needed for other aircraft to reach a combat zone. In that time a battle may have changed in complexion and even the weather may have changed.

Conventional aircraft often operate a 'cab-rank patrol' in anticipation of a call from ground troops with details of a specific target. But the Harrier can perform the same function by landing close to the battle area. The pilot can be briefed by radio and react to any target information received instantly. The aircraft can then be flown to a supported site for weapons replenishment before returning to its ground 'cab-rank' position.



In time of war, a typical RAF Harrier squadron's three flights would disperse to their own flying sites 'in the field' where the flight commander would become the site commander. The site would usually support up to seven Harrier aircraft. Sites can range from woodland or forest clearings to villages, wooded sections of motorways, farmyards and even supermarket car parks; once the glass fronts of the buildings have been bulldozed in to provide hides inside for the aircraft. In reality, aircraft hides in the field are invariably in wooded areas beneath overhanging trees. The site, disguised further by the use of camouflage netting, make it virtually invisible to ground or aerial reconnaissance.

For rolling take-offs a site needs a 350 metre section of metalled strip such as a straight section of road or motorway. "Mexes" metal landing pads can also be laid surrounded by trees, with double marker boards at each corner for the pilots to line up on for a vertical landing.



HARRIER JUMP JET

To support a flight of Harriers in the field requires fuel and weapons, de-mineralised water for the Harrier's thrust augmentation system, communications equipment, pillow tanks and tents, plus several hundred personnel. Packs of spare parts for the aircraft, spare tyres and other consumables are also kept at the flying site where complete engine changes can also be carried out (although this is a major operation requiring the use of a hoist and removal of the Harrier's wing).

The three flying sites within one squadron are supported by the squadron's central logistics park located nearby. This acts as a stockpile and distribution point for ammunition and fuel supplies.



**THE
DEVELOPMENT
OF THE
HARRIER**

HARRIER JUMP JET

THE DEVELOPMENT
OF THE HARRIER**Early Military V/STOL Aircraft**

The first country to experiment with the idea of vertical take-off (VTO) was Germany. Towards the end of World War II, the world's first true VTO aircraft was developed to be purely defensive, this aircraft was the Bachem Ba 349 'Natter' (Viper). The Ba 349 was a single-seat rocket-powered interceptor, armed with 24 unguided rockets, and was capable of only one flight.

After a vertical launch, the Natter would climb at 37,000ft per minute to an altitude of 20 to 25,000 ft and make its attack. When the engine had been shut down, the pilot would pull the control stick from its mounting, and the Natter would split into two pieces, one of which could be re-used. The pilot descended by parachute. The Natter never saw action, on its first manned flight a canopy malfunction caused it to crash, killing its pilot. The allied forces invaded Germany before any production Natters saw service, and a few years later surface-to-air missiles were performing the job which the Natter had been built for.

Germany had other VTO designs on the drawing board, but all had one thing in common- they were rocket powered. The German designers knew that a piston engine cannot generate enough thrust to lift an aircraft vertically.

Later, with the development of the jet engine came a new generation of vertical take-off and landing (VTOL) aircraft, which would eventually lead to the Harrier.

The first of the jet-powered VTOL was American. In 1951, the US Navy asked both Lockheed and Convair to produce prototypes for a possible VTOL combat aircraft. The result was two of the strangest

Early vertical take off aircraft were 'Tail-Sitters' that had to take off and land pointing straight up.



looking aircraft in the history of aviation, the Lockheed XFV-1 'Salmon' and the Convair XFY-1 'Pogo'. These aircraft were powered by turboprop engines, which use jet engines linked to propellers to generate thrust, and were 'tail sitters'; they had to take off and land pointing straight up.

The concept was doomed from the start. To land the 'Pogo', 'Skeets' Coleman, the test pilot, had to back the aircraft down from about 1000ft, with a helicopter calling out the altitude as he descended. This took a considerable time, and the landing was dangerously inaccurate. To land such an aircraft on the deck of a ship would be very difficult, if not impossible. The XFV-1 could not even manage to carry out one vertical take off, performing all test flights with a conventional undercarriage. The US Navy lost interest and cancelled the project in 1956.

The US Air Force learned from the mistakes of the US Navy, and worked with Ryan aircraft, to develop the X-13 Vertijet. This little aircraft was another tail sitter, but did not actually 'sit' at all, but hung from a framework via a hook on its nose. It used a single Rolls-Royce Avon jet engine for power, and to control the Vertijet at low speed, air was bled from this engine to power little puffer jets at the wing tips. The puffer jets would roll the aircraft when there was not enough air passing over the ailerons to provide roll control.

The Vertijet also had a simple thrust vectoring system (as in the modern day Harrier). The single exhaust nozzle could be moved around to help maintain stability in the hover. The Vertijet was the first jet aircraft to take off vertically, transition to normal flight, transition back to the hover then land vertically. It achieved this on 12th April 1957. Unfortunately, the aircraft was extremely difficult to control, especially during transition from normal flight to hover, or vice-versa, and was too small to be of any real military use. It was not long before the US Air Force followed the Navy and stop work on the X-13 project.

The limitations of the 'tail-sitters' (taking off facing up) were now apparent. These type of aircraft always needed to operate at weights below their engine thrust, because they had no other way of getting airborne and this meant that they could never match conventional aircraft in size and performance. In addition, they made flying a nightmare for any pilot, having to sit facing straight up, and especially when trying to land backwards.

British Developments

The British aircraft industry wanted to develop a supersonic VTOL jetliner, and Rolls-Royce started work on developing a rig for finding out how vertical flight could be achieved by a 'flat riser': an aircraft which takes off in the conventional (horizontal) attitude. The result was the Rolls-Royce 'Thrust Measuring Rig', known popularly as the 'Flying Bedstead'.

The Bedstead was powered by two 'Nene' jet engines, with nozzles both exhausting through the centre of gravity, so that the failure of one engine would not cause an instant crash. As a low-speed control system, it used puffer jets at the front, back, left and right of the aircraft to control pitch and roll, and the left and right nozzles could be tilted to control yaw. It first flew on the 9th July 1953. R.A Harvey, the test pilot, told the Press after the flight,

HARRIER JUMP JET

“The Bedstead was remarkably steady in that it remained firmly horizontal except when the stick was moved. It was difficult to believe that this top-heavy machine weighing over 3 tons, poised on the jet thrust, was being balanced by the four air nozzles.”

The Flat-Risers

It was apparent to the aircraft industry that the ‘flat riser’ concept was the most workable option and the race was on to find the aircraft which could put this concept into action.

The next batch of VTOL prototypes used tilting engines, that is the whole engine tilts through 90 degrees, to achieve transition from vertical to forward flight. The first of these types was the turboprop powered Bell XV-3, developed under a 1951 joint US Army/Air Force contract.

The XV-3 was a difficult machine to pilot, with no automatic stabilization system to help the pilot in the hover, and a downwards-firing ejector seat. It soon became clear that it was under powered and the project was cancelled.

The concept was taken one step further with the Boeing-Vertol VZ-2. In this design, the whole wing rotated, along with the engines. In effect, this meant that the wing would act like a sail, and the aircraft was vulnerable to even the gentlest of breezes. The VZ-2 was another failure.

The British Fairey Rotodyne first flew on 6th November 1957, and used a combination of a ramjet-driven rotor to achieve vertical flight, and two turboprops for forward flight. It was an interesting design, and provisional orders were placed by two airlines. However, it was noisy and lumbering to control and Fairey eventually stopped all work on the Rotodyne.

The Jet-Engines

It was apparent that, in order to achieve performance figures of comparable late 50s aircraft, VTOL research aircraft had to be powered by jet engines. Throughout this period researchers tried to find the best way to harness the power of a jet engine to achieve vertical flight.

The 'Flying Bedstead' was the Rolls-Royce thrust measuring rig - one of the first 'Flat-Risers' taking off in a conventional horizontal attitude.



The Bell X-14, which first flew in 1957, was the first aircraft to use diverted thrust. The thrust from the two jet engines was diverted downwards by a deflector plate on the wing, giving the aircraft a VTOL capability. Puffer jets at the wing tips gave directional control. The X-14 was too small to be of practical use, but it proved the theories which would be used later on.

The US Army/Ryan XV-5 Vertifan used the jet engine to drive three fans, mounted in each wing and the nose. The problem with this was that the weight of these fans, and the additional drag they created, made the aircraft difficult to control in forward flight. The aircraft was also very difficult to control in the hover, killing three test pilots before the project was cancelled.

The 1962 Lockheed XV-4 Hummingbird used another system: ejecting engine air over the wing to produce lift. This could not successfully achieve VTOL and unfortunately also ended up killing its test pilot.

Lift Engines

The next development were the 'lift engines': small jet engines pointing straight down, which are used only for vertical flight. The British Short SC.1 was a small delta-winged aircraft which used four lift engines and one conventional engine for forward flight.

This first hovered in 1958, but suffered from the classic problem of aircraft using lift engines: the airflow into the engines had a tendency to suck the aircraft onto the ground.

This same problem was also experienced by the French, with the Dassault Balzac in 1962. This aircraft had eight lifting engines, and was based on a Mirage III supersonic fighter airframe. The Balzac had another major problem: the speed at which the aircraft could transition from hover to forward flight was critical. In a test flight, the pilot attempted transition at the wrong speed and the drag of the lift engines became excessive. The aircraft see-sawed to earth like a leaf, exploded and killed the pilot.

In West Germany, both Focke-Wulf and EWR built VTOL prototypes, the VFW-1262 and the VJ-101. Both aircraft used a combination of lift engines and thrust engines, but used them in different ways.

The Focke-Wulf VFW-1262 used a vectored thrust engine (an engine with rotating thrust nozzles) to allow the same engine to be used for vertical or horizontal flight. This vectored thrust engine was not powerful enough to lift an aircraft by itself, so the VFW-1262 also employed two lift engines to achieve vertical flight but, the VFW-1262 could not achieve true VTO, and it was also cancelled.

The EWR VJ-101 was a very dramatic looking aircraft, using 6 Rolls-Royce RB.145 engines. Two were used as lift engines, and the other four were mounted as two pairs, in rotating pods at the wing tips. The EWR VJ-101 first flew in 1963, and had a supersonic performance. Several problems were encountered, however. The engines were so powerful that it wrecked anything which it landed on and melted its own tyres! In addition to this, an effect called 'hot gas recirculation' meant that it could not achieve maximum performance from its engines.

HARRIER JUMP JET

Hot gas recirculation is an important factor in VTOL. If the engine takes in exhaust gas, engine efficiency decreases, and as efficiency decreases, so does thrust. This problem is compounded by the particles of dirt and grit that the hot gas may contain, which can damage the engine. The Harrier overcame this problem by clever design of its intakes. The VJ-101 project continued, but suffered a major setback when the first prototype crashed in September 1964. The second prototype flew in 1965 with afterburning engines, only to be cancelled a few months later.

West Germany did develop one successful VTOL aircraft, the Dornier Do31 transport plane, designed to support the VJ-101 in the field. The Do31 was a ten-engined aircraft using two vectoring thrust Rolls-Royce Pegasus 5 (as used in the Harrier), and eight lift engines, arranged as two sets of four, in each wing tip. The prototype first flew, under Pegasus power only, on 10th February 1967, but the cancellation of the VJ-101 had left the Do31 without a military role, and it was deemed too expensive to develop the aircraft as a civilian transport. The Do31 was not officially cancelled, but the project was inadequately funded and allowed to die.

By now, VTOL aircraft were generally seen as impractical, unreliable, difficult to fly and generally inferior to their fixed wing counterparts and, understandably, the more conventional air forces were not eager to exploit the tactical advantages of VTOL combat aircraft. However, in 1960 an aircraft flew which would change history. The prototype was called the P.1127, and it would develop into what we know today as the Harrier.

In 1963 the EWR VJ-101 was capable of vertical take off and supersonic flight, but its engines were so powerful that they destroyed any landing surface and melted its own tyres!





The prototype P.1127 during a tethered hover test.

The P.1127

The Harrier story really begins in June 1957 at Hawker Aircraft, Kingston, England. It is here that Technical Head, Sydney Camm (designer of the WW2 Hurricane fighter) showed Chief Designer Ralph Hooper the technical specifications for a new engine: the Bristol BE53.

The BE53 was a unique engine because it had a relatively conventional intake and combustion chamber, but with three rotateable exhaust nozzles; the front pair blowing cold fan air, and the rear one blowing hot combustion chamber gases. This process allowed the engine to lift an aircraft vertically and then by rotating the nozzles to face backwards, the engine could propel the aircraft forward.

Ralph Hooper immediately started sketching his ideas for a vertical/short take-off and landing aircraft based around this engine, and the design was given the prototype designation P.1127.

The first design was known as the P.1127 HSH (High Speed Helicopter!). The shape of the P.1127 changed radically over those first two months on the drawing board. The first sketches were of a three-seat light observation aircraft, soon to develop into a two-seat armed observation aircraft, and finally a single-seat light strike aircraft. By then, the BE53 had become a four-nozzle engine with the single rear (hot) nozzle split into two.

HARRIER JUMP JET

It was clear at this early stage that some form of low speed control had to be devised, because the aircraft would be uncontrollable at speeds below stalling speed.

Conventional aircraft controls work by deflecting a part of the trailing edge of the wing, tailplane or rudder and the airflow over this surface creates a force which makes the aircraft roll, pitch or yaw respectively.

The P.1127 could not use this system at low speed because airflow over the control surfaces would not generate sufficient force to control the aircraft. The system which the P.1127 used, and the Harrier still uses today, is the reaction control system (RCS). This operates simply by blowing air out of the nose, tail and wing tips giving full control over roll, pitch and yaw, even at zero forward speed.

Work stopped on the P.1127 at Hawker for the last two months of 1957 as the company fought to get its P.1129 supersonic strike aircraft approved by the UK Ministry of Defence (MoD). In the end, a competitors design, the BAC TSR.2, was chosen to fill this contract. Hawker were disappointed at losing this major contract, and returned to the P.1127 project. As fate would have it, the TSR.2 was cancelled in 1965, a blow from which the UK aerospace industry has never recovered. Had the P.1129 been chosen to fill this contract, the engineers at Hawker would have been tied up working on this, and the world may never have even seen the Harrier!

When work on the P.1127 resumed in January 1958, the last details of the basic design, such as the unusual centre-line undercarriage configuration, had still to be worked out. The reason for this configuration is because the rearmost, hot engine exhaust nozzles would melt any tyres which were in their path, so the wheels have to be placed out of the path of any jet exhaust. This undercarriage layout had been used before, on heavy bombers such as the B-52. The result of using this undercarriage arrangement is that the nose wheel carries an unusually high load, meaning that the aircraft does not 'rotate' on take-off, it just rises into the air. The fact that it does not rotate was countered by giving the aircraft a nose-high attitude when sitting on the ground. The wing was given a pronounced anhedral to minimise the length of the outrigger wheels at the wing tips and this also assisted stability in the hover.

The RAF were consulted at this stage, to determine orders for production P.1127s if the aircraft flew successfully. The RAF stated that they were not interested in the P.1127 unless it was capable of supersonic performance, since they had a need for a supersonic interceptor, not a ground attack airplane.

Stanley Hooper visited the United States in July 1959, and went to see the VTOL Bell X-14, at NASA Langley. It was here that John Slack, a director of the Langley facility, offered to build and test several models of the P.1127, using funding from the USAF. Stanley accepted gratefully, knowing that NASA had some of the finest wind tunnel facilities in the world.

In the last months of 1959, the first UK wind tunnel test results were compiled, from RAE Farnborough, and they proved to be extremely disappointing. The tests concluded that the P.1127 was highly unstable in pitch in the hover, making it uncontrollable, and deadly for any test pilot. This was due to the jet downwash blowing down on the tailplane, causing a severe nose-up pitch. Hawker were ready to end the project. They waited to see if the USA wind tunnel tests revealed the same problem.

At NASA, Marion 'Mac' McKinney dismissed the RAE tests, and in early 1960 proved them to be incorrect. The P.1127 was stable in the hover, and was almost stable in the transition from hover to forward flight. He declared that 'transitions were immediately successful', but called for a more powerful elevator to overcome pitch instability problems during the transition. The UK MoD now took an interest in the project, and provided funding for four aircraft, covering the first 4 development P.1127s.

The company finished construction of the first P.1127 (serial number XP831) in July 1960, and the aircraft was taken to Dunsfold airfield, the Hawker flight test site. In the meantime, at Bristol Aero Engines, the BE53 had been redesigned again, now generating 5125 kg of thrust, and given the name, 'Pegasus', after the flying horse from Greek mythology. It was fitted to the Harrier in September 1960, and all was set for the first flight.

In March 1960, A.W. 'Bill' Bedford, chief test pilot for Hawker Aircraft, was assigned to fly the P.1127. He had already visited NASA to examine the American VTOL prototypes, and had already flown helicopters as preparation.

Flying Prototypes

On 21st October 1960, 'Bill' Bedford became the first pilot to fly the P.1127. The aircraft was positioned over a grid to stop recirculation of exhaust gases, and was tethered by ropes to stop it from drifting around, or turning over. In the early tests, the aircraft weighed just 4,192 kg and was limited to three minutes fuel. The tethered tests continued until the 19th November 1960, when the aircraft flew properly for the first time. The aircraft continued its tests in the hover for some time, at various altitudes and weights, but did not use the wing as a source of lift until 13th March 1961, when the nozzles were pushed back and the P.1127 flew in the conventional mode.

The second P.1127 (XP836), first flew on the 7th July 1961, using conventional take-off and landing (CTOL). The tests proceeded, and on 12th September XP831 made the historic transition from hover to conventional flight, and back to hover. It should be noted that, in the early tests, the pilots sat on old technology ejector seats, different to modern zero-altitude, zero-air-speed (zero-zero) seats. If the pilot wanted to get out of the aircraft, he had to be moving along at 90 kts minimum. This meant that the only way out of the aircraft in the hover was to climb out of the canopy.

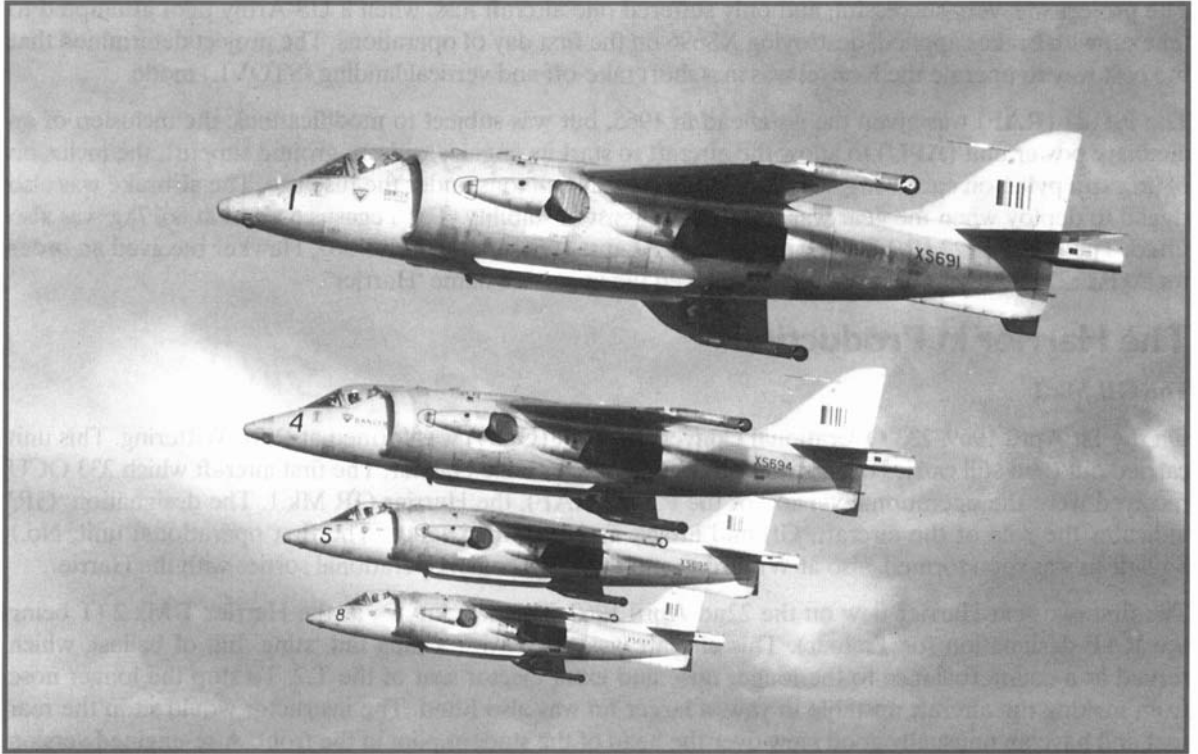
The short take-off tests performed in October 1961 showed that a short ground run would enable the P.1127 to get airborne with a greater load, due to the combination of jet lift and wing lift. Tests continued without incident, then on 14th December 1961, disaster struck!

Bill was flying XP836 near Yeovilton, Somerset, performing high-speed tests, when the front, left nozzle detached from the aircraft. Bill immediately slowed down, lowered the gear, and attempted to land at the Fleet Air Arm base nearby. The aircraft became more and more uncontrollable as speed dropped off, and began a slow roll to the right, even though Bill had the stick full left. Bill ejected safely, with the aircraft at 30 degrees of roll, the aircraft plummeted into the ground, and was destroyed. The lesson learned from this crash was to manufacture the front nozzles in stainless steel, not the fibreglass, which the prototypes had been made from.

HARRIER JUMP JET

The first development aircraft, XP972, flew on the 5th April 1962. This too was the subject of an engine failure but managed to, make a successful glide landing.

In May 1962, the go-ahead was given for the 'Kestrel' project; a large injection of funds to get an operational aircraft from the P.1127 design.



The Kestrel introduced an entirely new wing including new style weapons pylons.

The Kestrel

When the Kestrel project began at Hawker, Bill was still flight testing the XP831, and made the first landing aboard an aircraft carrier, HMS Ark Royal, on 8th February 1963. By this time, three other development aircraft had been built, and fitted with the Pegasus 3, capable of generating 6122kg of thrust. The last development P.1127 (XP984) was soon retro-fitted with the Pegasus 5, rated at 7030kg. This aircraft became the prototype for the Kestrel.

For the Kestrel, Hawker made several modifications to the basic P.1127. The tailplane was drooped, to cure the hovering stability problems and the RCS was upgraded for a better response. The aircraft was also given a pylon on each wing for the carriage of weapons, and a reconnaissance camera was fitted in the nose. The final Kestrel aircraft also had modified intakes, with blow-in auxiliary intake doors.

The Kestrel operational evaluation was funded in 1964 by the UK, Germany and the USA and took the aircraft through a nine month evaluation to determine how best to use a V/STOL aircraft 'in the field'. The project was very successful, and only suffered one aircraft loss, when a US Army pilot attempted to take off with brakes applied, destroying XS696 on the first day of operations. The project determined that the best way to operate the Kestrel was in a short take-off and vertical landing (STOVL) mode.

The P.1127 (RAF) was given the go-ahead in 1965, but was subject to modifications: the inclusion of an auxiliary power unit (APU) to allow the aircraft to start its engines without ground support, the inclusion of an extra pylon on each wing, and two 30mm ADEN cannons under the fuselage. The airbrake was also rigged to deploy when the gear was lowered, to assist in stability. The Pegasus 6 rated at 8617kg was also fitted. The first P.1127 (RAF) flew on the 31st August 1966, and in early 1967, Hawker received an order for 90 P.1127 (RAF)s. These aircraft were given the in-service name 'Harrier'.

The Harrier in Production

The GR Mk.1

On the 1st April 1969, 233 Operational Conversion Unit (OCU) was formed at RAF Wittering. This unit carried out (and still carries out) transition of RAF pilots to the Harrier. The first aircraft which 233 OCU received were the operational version of the P.1127(RAF), the Harrier GR Mk.1. The designation 'GR' indicates the role of the aircraft, Ground attack and Reconnaissance. The first operational unit, No.1 Squadron was soon formed, also at Wittering, and the RAF began operational sorties with the Harrier.

The first two-seat Harrier flew on the 22nd April 1969. This was known as the Harrier T Mk.2 (T being the RAF designation for Trainer). This aircraft was fitted with a long tail 'sting' full of ballast, which served as a counterbalance to the longer nose and extra ejector seat of the T.2. To stop the longer nose from making the aircraft unstable in yaw, a larger fin was also fitted. The instructor would sit in the rear seat and have an unusually good view over the head of the student pilot in the front. A re-engined version of the T.2, known as the T.4, came into service in 1975.

In 1972, No.3 and No.4 Squadron became operational, at RAF Wildenrath, Germany. This gave the RAF a chance to operate the Harrier from pre-prepared 'hides' in the German countryside. These types of base are known to the RAF as 'forward operating locations' (FOLs). Working from a FOL, it was found to take 20 minutes to re-fuel and re-arm a Harrier between sorties, and a single Harrier was able to generate up to six sorties a day. It was also found that old FOLs could be re-activated in just three hours. In 1977, the Harriers of No.3 and 4 Squadron moved to a position even nearer East Germany, RAF Gutersloh, just 65 miles (about six minutes flying time) from the 'Iron Curtain'.

HARRIER JUMP JET

The GR Mk.3

In 1975, the RAF introduced a new variant of the Harrier, the GR.3. This aircraft was based on the GR.1, but with several major differences. The main visible difference was the addition of a laser rangefinder and marked target seeker (LRMTS) in the nose. This allowed the GR.3 to measure the distance from a target to the aircraft via a laser beam which is being fired at the target by ground troops, or other aircraft. The Harrier can then bomb the target with extreme accuracy, at high speed. The other external difference was the fitting of a radar warning receiver (RWR) on the fin. This tells the pilot if he is being scanned by enemy radar. The GR.3 was also given a new engine, the Pegasus 11, rated at 9750 kg thrust. The existing GR.1s in service were soon re-fitted with GR.3 systems, making the GR.3 the only operational RAF variant of the Harrier until the GR.5 arrived on the scene.

The FRS. 1

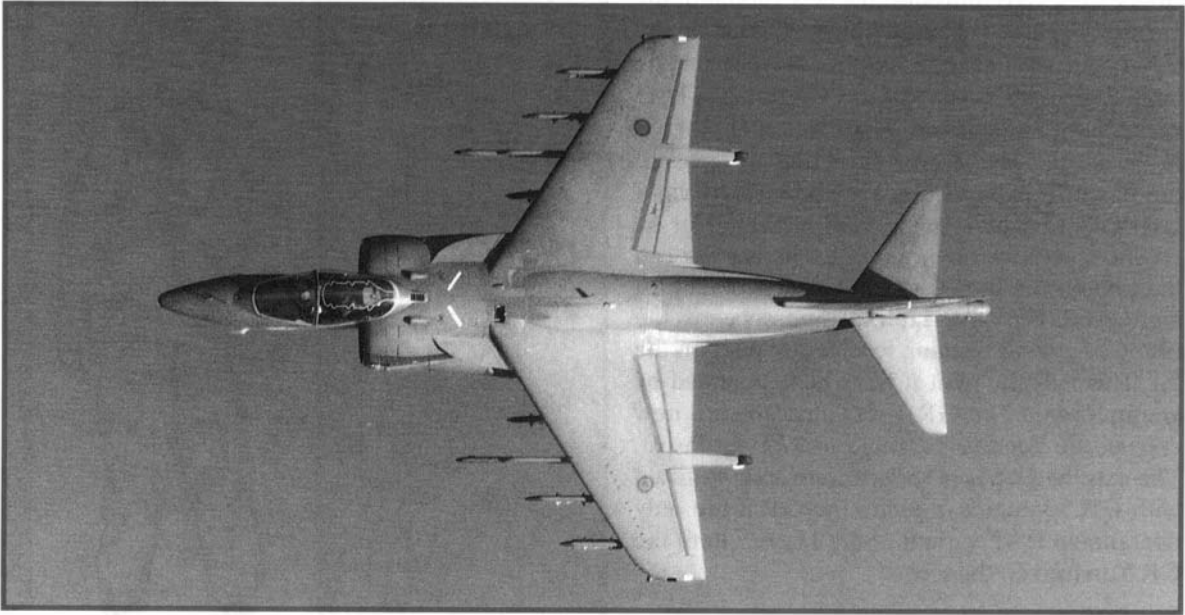
In August 1978, the Sea Harrier FRS.1 flew for the first time. The FRS stands for 'Fighter, Reconnaissance and Strike' (S for 'strike', as opposed to G for 'ground attack', implies the use of nuclear weapons). This aircraft was based on the GR.1, but optimised for operation from aircraft carriers. The Sea Harrier entered service with the Royal Navy Fleet Air Arm (FAA) in June 1979, and by April 1982 four FAA squadrons were flying the Sea Harrier.

The Falklands war of 1982 proved the Harrier to be a success, a force of 28 Sea Harriers accounted for 20 confirmed and 3 probable Argentine aircraft kills for no loss in air-to-air combat. It should also be remembered that these aircraft spent a lot of their time flying in conditions which would have stopped conventional aircraft from operating.

The designation GR indicates the role of the aircraft: Ground Attack and Reconnaissance.



The GR Mk.5



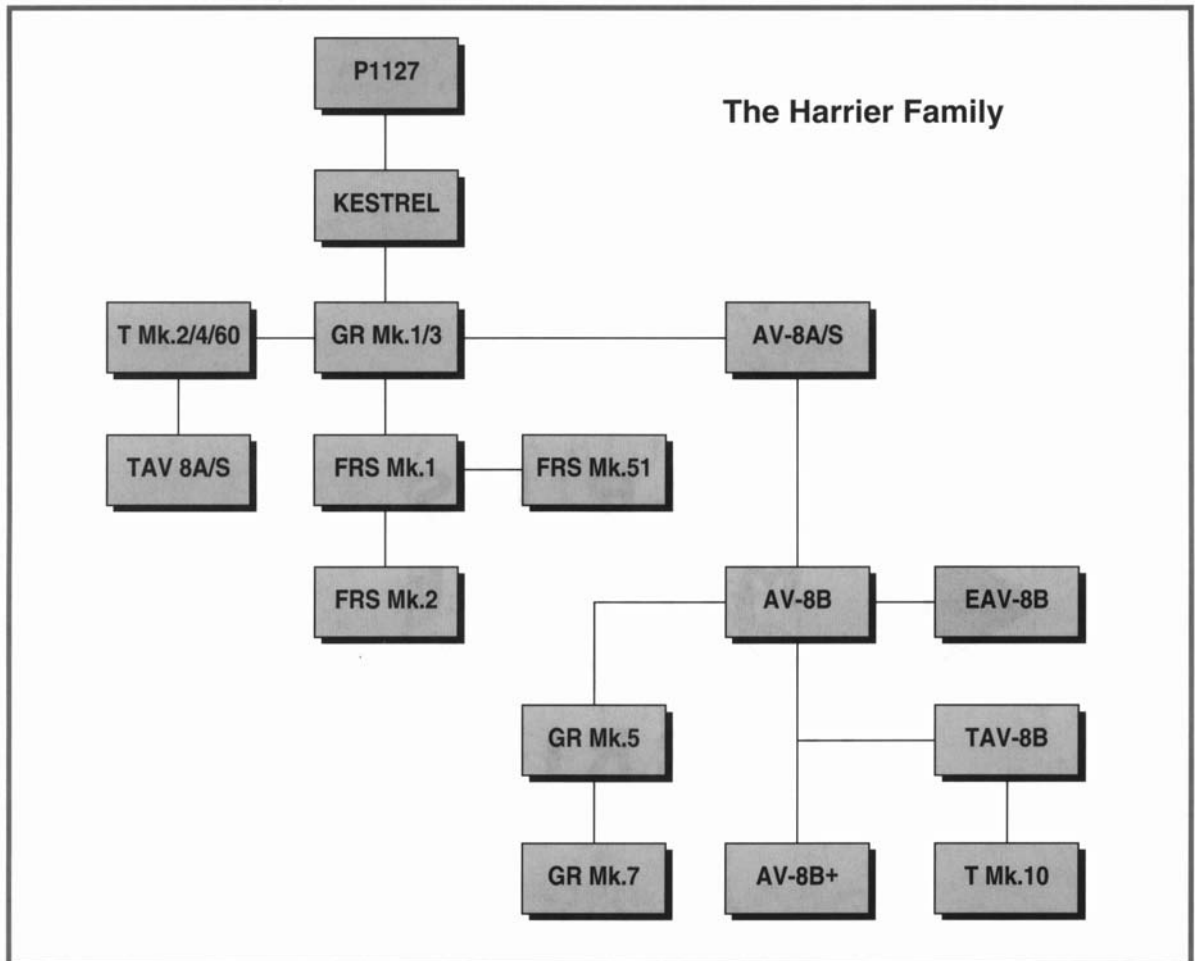
After several years of debate and political wrangling on whether to design and build a new version of the Harrier in the UK, the decision was made to buy modified AV-8Bs (see *The USMC Harrier* below). These aircraft were built in 50/50 proportions by the US and UK, and came into service with 233 OCU in 1987 as the Harrier GR.5.

In 1987, the night attack Harrier II flew for the first time. Equipped with a forward-looking infra-red (FLIR) sensor, a wide angle HUD to display the FLIR information, a digital moving map in the cockpit and new cockpit displays, the night attack Harrier II can strike a target at any time, in any weather. When flying at night, the pilot wears night vision goggles (NVGs) which display the night landscape by enhancing available light. The NVGs are set to cut off when the pilot looks straight ahead, through the HUD. The FLIR displays the night landscape in shades of green and is then used to attack the target.

The GR Mk.7


In 1988, the RAF announced that it was buying the night attack Harrier, as the Harrier GR.7. This brought the total number of Harrier GR.5/7 in RAF service to 94. The GR.7 made its first flight on the 20th November 1989. In addition to the night attack modifications, the GR.7 also features two undernose antenna for the 'Zeus' self defence system.

HARRIER JUMP JET



The Night Attack Harrier II

Today, as the night attack Harrier comes into service in the UK and USA, this little V/STOL aircraft will be one of the most capable attack planes in the world, able to operate from austere forward operating locations and attack with precision in any weather, day or night.



**THE US
MARINE
CORPS
HARRIERS**

THE US MARINE CORPS HARRIERS

The United States Marine Corps (USMC) first became interested in the Harrier in September 1968, when two USMC pilots were allowed to evaluate the Harrier at the Farnborough air show.

Until the advent of the Harrier, the USMC had a problem with aircraft procurement, because all of its funding came from the US Navy. The Department of Defense insisted that the Marines buy Navy aircraft, to allow them to operate from aircraft carriers. The problem was that the USMC had a desperate need for a close air support (CAS) aircraft; to support its troops on the front line.

Carrier-based aircraft spend too long getting to the front line, so an aircraft was needed that could operate from forward airstrips. The only USMC aircraft up to this job was the A-4 Skyhawk. Once the A-4 had disembarked from its carrier, however, it needed a 4000ft runway constructed out of aluminium planking to operate from.

The Harrier appealed to the USMC because it can take-off, with a useful weapons load, from a runway of just 1000ft in length. So the USA bought a foreign aircraft to go into its front line forces, this was, and still is, virtually unheard of. The USMC was so desperate to get the aircraft into service that it was willing to give up 17 F-4J Phantom IIs in order to get 12 Harriers.

The AV-8A

The first USMC Harrier flew on the 20th November 1970, and was given the US service designation 'AV-8A' (A stands for attack, V stands for vertical take-off, 8 stands for the eighth such aircraft to be built and A stands for the sub-type).

The US Marine Corps needed an aircraft that could operate close to the front line without having to be carrier-based. They chose the Harrier.



The AV-8A was basically the RAF Harrier GR.1, but with some minor differences. Internal modifications consisted of the installation of American avionics, systems and ejector seat, and provision was made for the carriage of AIM-9 Sidewinder missiles. The only major external difference between AV-8A and GR.1 was the large VHF 'blade' antenna, mounted on the top of the fuselage.

The USMC eventually took delivery of 102 single-seat AV-8A Harriers, and eight two-seat TAV-8A Harrier Trainers. The production run of 110 aircraft was not large enough to set up a production line in the US, so all of the first 110 AV-8s were built at Kingston and flown to America in transport aircraft.

The Development of Harrier Combat Tactics

The USMC soon recognised the potential for air-to-air combat that vectored thrust had to offer, and Lt. Col. 'Harry' Blot performed some pioneering work on the technique of vectoring in forward flight (VIFF), known to Harrier pilots as 'viffing'.

The first time Blot viffed was at 500 kts, in level flight. He had not tightened his shoulder straps because he did not anticipate any major effects and simply pulled the jet nozzles lever to the rear stop, and (as he describes it),

"...the airplane started decelerating at an alarming rate, the magnitude of which I could not determine because my nose was pressed up against the gunsight. I was now straddling the stick, with my right hand extended backwards between my legs, trying to hold on for dear life."

The USMC officially accepted viffing as an effective means to dislodge a hostile fighter from the tail of a Harrier. The manoeuvre is carried out as follows:- the nozzles are pulled forwards which results in a large deceleration; the attacker is forced to overshoot. The Harrier pilot then pushes the nozzles to face backwards, and instantly has 100% of his thrust pointing straight back, accompanied by a rapid acceleration. The Harrier pilot is then in a ideal position to bring his missiles or large-calibre guns to bear on the attacker. This manoeuvre has surprised many an F-15 pilot, in their attempts to down USMC Harriers in simulated air-to-air combat.

The reason that viffing is so effective is because the engine does not have to lower its RPM over any part of the manoeuvre, whereas a conventional aircraft would have to throttle back to make an opponent overshoot. The effectiveness of viffing on turn radius is minimal, however, since it only adds around 0.5'g', this means that a Harrier cannot use viffing to out-turn a dedicated dogfighter like an F-16.

The AV-8B Harrier II

On 5th November 1981, a complete redesign of the Harrier, the AV-8B Harrier II, flew for the first time. Since the early 70s, McDonnell Douglas had been working on a redesigned Harrier, using new materials technology. The result of all this research was a new wing for the Harrier, made out of carbon-fibre composite. The new wing also featured enlarged flaps, an extra stores pylon (making a total of three per

HARRIER JUMP JET

wing) and re-positioned outrigger wheels, to help when operating from narrow airstrips. The new wing was flown on an AV-8A in November 1978.

The end result of all the modifications is an airplane which can take off 3039kg heavier than an AV-8A, carry the weapon load further, and deliver it with twice as much accuracy. In simulated air-to-air combat with US fighter aircraft such as F-4 Phantoms, F-14 Tomcats and F-15 Eagles, the AV-8B has achieved an overall success rate of 2:1.



An AV-8B of VMA-331 'Bumblebees' flies over the desert carrying 500 lb 'Snakeye' retarded bombs.

The Squadrons

On 15 April 1971 the first US Marine Corps Harrier squadron was established within Marine Air Group 32 (MAG-32) at Beaufort, South Carolina flying the AV-8A (the Harrier's US designation). In 1992 there were eight USMC front-line and training squadrons operating the AV-8B and AV-8B Night Attack version of the Harrier II:

VMA-513 "Flying Nightmares", VMA-542 "Flying Tigers", VMA-231 "Aces", VMAT-203 "Hawks", VMA-331 "Bumblebees", VMAT-223 "Tomcats", VMA-311 "Bulldogs", VMA-214 "Black Sheep" and VMA-221 "Wake Island Avengers".

Trainee USMC AV-8B pilots receive 60 hours training with VMAT-203 over a period of 22 weeks for them to achieve a combat-capable rating before they are transferred to an operational squadron to work up to combat-ready status.

USMC AV-8Bs differ from their RAF Harrier GR7 counterparts in a number of ways, the most obvious of which include the fitting of the more powerful Rolls-Royce Pegasus F402-RR-408 (11-61), a slightly different avionics and a range of weapons options that exceed those of the RAF's GR7.

USMC Harrier Operation

From the outset, the USMC intended to operate the AV-8B from ships as well as from airfields and dispersed sites to support the Marines on the ground. However, as yet no US Navy ships have been permanently assigned to operate or transport USMC AV-8B squadrons.

The USMC uses three different types of bases, the largest of which is either an aircraft carrier or an airfield with full facilities. Next is what is known as a "facility": an airstrip 600-800ft long and closer to the battlefield from where AV-8Bs can make short take-offs and landings. The facility has rudimentary provision for maintenance, basic navigational aids, fuel and ordnance. It is the equivalent to the RAF's forward operating base which is known as a flying site. Closest to the battlefield is the forward site where the AV-8Bs operate off rough ground, a strip of road or a 72ft x 72ft aluminium metal pad. An AV-8B flies fully armed and fuelled from a facility to the forward site where it waits on the ground in a "cab-rank" arrangement until called in to attack by the forward air controller.

This practice differs somewhat from the RAF's method of operating Harriers in the field from dispersed flying sites, the equivalent to USMC "facilities". USMC AV-8Bs are generally expected to fly in close-support of a Marine amphibious landing, expanding a beach-head, whereas the RAF Harriers are tasked with supporting a defensive landbattle in an area where a rapid advance by enemy forces could overrun flying sites, hence their situation further from the battlefield than USMC forward sites.

Combat Operations

LEBANON

VMA-231 "Aces" and its AV-8As were despatched aboard USS *Tarawa* in April 1983 for seven months off the coast of Lebanon to support the UN peace keeping force.

OPERATION "DESERT STORM"

With the mounting of Operation "Desert Storm", AV-8Bs of the US 1st Marine Expeditionary Force played their part in close air-support against Iraqi artillery and armour. The use of the Hughes AN/ASB-19 ARBS in the AV-8B's nose tip enabled an accurate delivery of weapons, mainly in the form of Cluster Bomb Units (CBUs), in dive attacks. Napalm and fuel-air explosive were also dropped. Most sorties were flown at high level because of Iraqi heavy Anti-Aircraft Artillery (AAA) lower down and the lack

HARRIER JUMP JET

of high altitude Surface-to-Air Missiles (SAMs). AV-8Bs developed a system of dropping chaff in the dive and flares on the recovery after the attack.

VMA-311 "Bulldogs", VMA-331 "Bumblebees" and VMA-542 "Flying Tigers" operated their AV-8Bs from the metalled runways of Al-Jubayl Air Base in Saudi Arabia, despite their suitability for operations from forward strips close to the battlefield. USMC Rockwell OV-10A Bronco spotter aircraft kept the battlefield under constant observation, calling in air strikes by Marine AV-8Bs to destroy Iraqi artillery batteries along the Kuwaiti border and later to help halt the Iraqi push at Khafji in late January. Ten AV-8Bs of VMA-223 "Tomcats" remained embarked aboard USS *Saipan* in case amphibious operations were launched against the Kuwaiti coast.

***USMC
Harriers fly in
close support
of marine
amphibious
landings, and
assist in
expanding
beach heads.***





**THE
FALKLANDS
WAR**

HARRIER JUMP JET

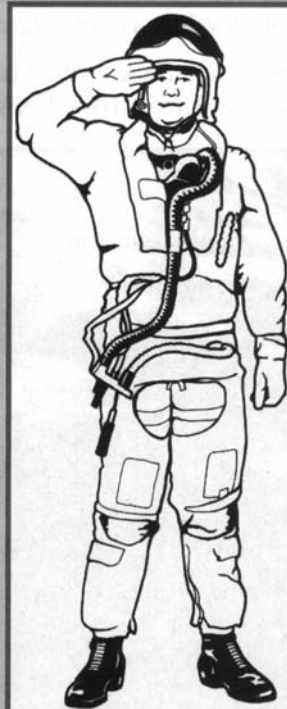
THE FALKLANDS WAR

On 19 March 1982 a small Argentinean force landed on the island of South Georgia, a British dependency in the south Atlantic, ostensibly to dismantle a derelict whaling station. On 2 April Argentinean military Task Groups landed on the long-disputed Falkland Islands, overpowered the small Royal Marine garrison after a short fight and declared the Falkland Islands to be a part of Argentina.

The invasion had been anticipated for some time by British intelligence and on 31 March a decision had already been taken to assemble a task force capable of retaking the Falklands if necessary, and Operation "Corporate" was set in motion. A complex military Task Force involving thousands of troops, a fleet of ships drawn from the Royal Navy and the Merchant Marine supported by aircraft from all three services sailed on 5 April to a destination 8,000 miles across the world where, after a hard fight and the loss of irreplaceable men, valuable ships and aircraft, the Falkland Islands were finally retaken on 14 June and the Argentine commanders compelled to sign the surrender.

The principal air components of the British Task Force were the Royal Navy aircraft carriers HMS *Hermes*, HMS *Invincible* and HMS *Illustrious* with Sea Harrier FRS1s of 800, 801 and 809 Naval Air Squadrons (NAS) embarked. RAF Harrier GR3s from No 1 Squadron, Wittering, were earmarked to join the Task Force in the South Atlantic to reinforce the RN's Sea Harrier FRS1s in the air defence role. Fitted with long range ferry tanks and refuelling probes the RAF's GR3s flew south on 4 May from St Mawgan to Ascension Island on a 4,600-mile 9.25 hour almost non-stop record-breaking flight, accompanied by Handley Page Victor tankers. Here they were flown aboard the container ship MV *Atlantic Conveyor* with Sea Harriers of 809 NAS and Boeing - Vertol Chinook helicopters for the final journey south. The FRS1s and GR3s were finally cross-decked to HMS *Hermes* on 18 May, their home for the duration of Operation "Corporate". With the cessation of hostilities No 1 Squadron's GR3s were land-based at Port Stanley airport from 4 July until 10 November.

Argentine pilots were reluctant to 'mix-it' in close combat with Harriers. They knew that Viffing made them too unpredictable.



Royal Navy Sea Harrier FRS1s

During Operation “Corporate”, the carrier-based Sea Harrier FRS1s had a four-fold role: mounting Combat Air Patrols (CAP) to defend the Task Force fleet; anti-shipping strikes; tactical reconnaissance; and a new role of ground-attack. As the only member of the Harrier family with a primary air-combat role, the FRS1 was fitted with single Sidewinder launch rails beneath each wing, although a twin-rail launcher was hastily developed during the conflict.

FRS1s were armed with a combination of AIM-9L Sidewinder AAMs; twin 30mm ADEN cannon pods; Hunting BL755 CBU; FAA 2in rocket pods (for possible anti-armour and shipping attacks); Paveway laser guided bombs (LGBs); 1,000lb (454kg) iron bombs; Tracor ALE-40 chaff/flare dispensers mounted in the rear fuselage to improve self defence; two 190 gallon drop tanks were carried to extend combat range. Twenty-eight Sea Harriers were deployed to the Falklands and flew more than 1,100 CAPs and 90 offensive support operations for the loss of six aircraft, but none in combat.



Combat ready Harrier GR.3s and Sea Harrier FRS1s preparing to attack Argentine targets in the Falklands

Royal Air Force Harrier GR3s

Initially, tasked to fly in an air-defence role, the RAF's Harrier GR3s were hastily converted to carry AIM-9G Sidewinders in support of the RN's Sea Harrier FRS1s, but once the latter had firmly established air superiority over the *Fuerza Aerea Argentina* (Argentinean Air Force) the 10 GR3s of No 1 Squadron were free to operate exclusively in their normal ground-attack or low level reconnaissance role from HMS *Hermes* and, later in the conflict, from the Forward Operating Base at San Carlos.

HARRIER JUMP JET

Weapon fits included Hunting BL755 CBU's to attack enemy fuel dumps, parked aircraft and vehicles; Pave Way laser-guided bombs launched against Argentinean artillery and command positions; 1,000 lb retard bombs for cratering grass airstrips and the concrete runway at Port Stanley; FAA 2in rocket pods. Tracor ALE-40 chaff/flare dispensers were hurriedly fitted to improve their self defence. Aircraft were also equipped with a pair of 100 gallon drop tanks to extend their combat range. The squadron lost four GR3s during the battle to regain the Falklands, but none in combat.



A GR3 fires a salvo of rockets.

Combat Tactics

Both Navy and RAF pilots believe that their realistic training programmes in peacetime enabled them to gain, and then maintain, air superiority over the Falkland Islands in 1982, despite being heavily outnumbered. It also transpired afterwards that Argentinean pilots were reluctant to "mix it" in close combat with Harriers and Sea Harriers, at any altitude, because they knew that VIFFing could cause the enemy aircraft to behave in an unpredictable manner.

Due to problems with the Sea Harrier's INS, the FRS1s accompanied the RAF GR3 missions from *Hermes* until landfall was made to share the benefit of the latter's accurate over-sea navigation equipment.

Combat Air Patrols (CAP)

CAPs were flown both by Sea Harrier FRS1s and Harrier GR3s from onboard the British carriers *Hermes*, *Illustrious* and *Invincible*. Armed with AIM-9G and L Sidewinder AAMs the CAPs were flown from low to medium level and at heights of up to about 38,000ft. However, the exact patrol heights were dependent upon the prevailing weather conditions, visibility, the need to conserve valuable fuel reserves, as well as the operating height of Argentinean aircraft.



A Harrier armed with Sidewinders takes off on a combat air patrol over Port Stanley

Ground-Attack Missions

Because of the nature of warfare, it is only a fool who adheres rigidly to textbook mission profiles when circumstances are crying out for him to be innovative and modify his tactics to suit the changed situation. This was very much the case during the Falklands conflict since many of the textbook attack profiles had been written with north-west Europe in mind, where encounters with enemy fighters, high tension cables, expanses of woodland and built up areas would be far greater.

The following is a typical ground-attack mission profile as flown by Sea Harrier aircraft during Operation "Corporate". It could also quite easily have been flown by a mixed Sea Harrier and Harrier force.

Twelve Sea Harriers from *Hermes* were detailed to attack the airfields at Port Stanley and Goose Green. Sidewinder and cannon-armed Sea Harriers from



HARRIER JUMP JET

Invincible were to provide top cover in case any Argentinean fighters tried to interfere. Armed with Hunting BL755 CBU's, 1,000 lb bombs fitted with instantaneous, delayed action and radar airburst fuses, the ground attack force took off from *Hermes* and ran in to the targets at 50ft. The aircraft pulled up to 150ft at a speed of between 500-600 kts to drop their bombs before easing back down to ground level on recovery, dumping chaff in a series of tight manoeuvres to brake the lock-on from radar-guided Fledermaus ground-to-air missiles. Once out of range of the defences, the force climbed to altitude to return to the ship where they made a vertical recovery.

Early in the conflict, attempts to use the GR3's LRMTS (Laser Ranging and Marked Target Seeking) equipment to designate for Sea Harriers using Pave Way LGBs was unsuccessful. Later attacks by GR3s with LGBs using ground-based laser designators gave better results.

For attacks on Port Stanley's runway, a mixed weapon load of CBU's, 1,000lb bombs and FAA 2in rocket pods were also used, but due to the very low release height the accuracy of the bombs was poor.

HARRIER
PILOT
TRAINING



**HARRIER
PILOT
TRAINING**

HARRIER JUMP JET

HARRIER PILOT TRAINING

Harrier flying is obviously very different from that of other more conventional aircraft and for this reason pilot training is markedly different and has to be more intensive.

The RAF trains its Harrier pilots to fly at No 233 Operational Conversion Unit (OCU) at Wittering in the East Midlands where a mixture of Harrier GR3, GR5 and T4 aircraft are used in this task. Training is not cheap: it costs the RAF somewhere in the region of £2-3 million at 1992 prices to train a Harrier pilot, representing a huge investment in specialized aircrew.

Pilots begin their training with a three day survival course then aeromedical tests where they are all given tailor-made skeletal harnesses. Initially, to acclimatise the pupil pilot to the peculiarities of VSTOL flying, a six hour course on the Aerospatiale Gazelle AH1 helicopter introduces him to hovering and transition to forward flight. Understandably, fixed-wing fliers can find it difficult to overcome their natural aversion to stopping an aircraft in mid-air and operating at heights between 50 to 100 feet.

A short course on the Harrier T4 two-seat trainer and then the single-seat GR3 gives an introduction to the VSTOL capabilities of the Harrier in 16 sorties totalling some seven to eight hours, before moving on to the GR5/7.

Next, there follows a two-week ground school course using interactive computer-based systems with touch-screens to teach all of the Harrier's systems and emergency procedures. The pupil then "flies" the GR5/7 flight simulator to put theory into practice. Here he learns more about the type's general handling characteristics, instrument flying and emergency procedures.

Conversion Training: Basic Squadron

Eighteen sorties of conversion training are then flown to learn the specialized take-off and landing techniques peculiar to the Harrier: there are five different ways to take-off and another five different ways to land which need mastering, in addition to learning about the different surfaces a Harrier can operate from which include tarmac, grass strips and aluminium tracking.

To appreciate just how difficult it is to master the Harrier's take-off and landing characteristics, compare this element of training with the mere three to four sorties flown by pilots of conventional jet aircraft like the Tornado.



RAF Harrier pilot training costs £2-3 million per candidate.

The next step in the training process is in basic navigational techniques, close and tactical formation flying, and basic air-combat training (including VIFFing) on a one-versus-one basis. This includes tuition in the use of air-to-air missiles and their handling characteristics. Once the basic conversion onto type training is complete, the pupil pilot fully-schooled in navigational techniques and combat training, transfers from the Basic or "A" Squadron to the Advanced or "B" Squadron of the OCU.



A makeshift hide. The Harrier sits on strips of aluminium tracking.

Conversion Training: Advanced Squadron

Training on the Advanced Squadron begins with two weeks ground school on the weapons system simulator, where the trainee can learn and practise the various weapons delivery profiles. There then follows live flying in a GR5/7 to put into practice all the various delivery profiles on ranges in the UK. Simulated attack profiles with no weapons onboard are also flown over selected targets around the UK. To see just how good the pupil pilot has become, an offensive 'loose goose' aircraft is tagged onto his Harrier to simulate a 'bandit'. The pilot must do his utmost to lose him by manoeuvring the Harrier.

Electronic Countermeasures (ECM) training is undertaken next at the Spadeadam range in Northumberland where trainees have the opportunity to use chaff and other features of the Harrier's ECM system against 'live' threats.

HARRIER JUMP JET

Conversion Training: Operational Phase

Several months hard work is then put to the test when all pupil pilots on the OCU are taken away from the familiar environment of their home base to operate from another airfield in the UK. Detailed sortie planning is the order of the day and flying exercises, in which the various ground and air threats which could be encountered in an operational scenario are simulated, help to make the training as realistic as possible for the pilots.

'Pairs Leader'

When course is complete a 'Pairs Leader' (the lead pilot of a pair of Harriers) is the standard delivered from the OCU to an operational Harrier squadron.

Night attack, low-level flying and air-to-air refuelling techniques are taught on the squadron along with close-air and multi-ship combat training.



A Harrier pilot performs an air-to-air refuelling manoeuvre

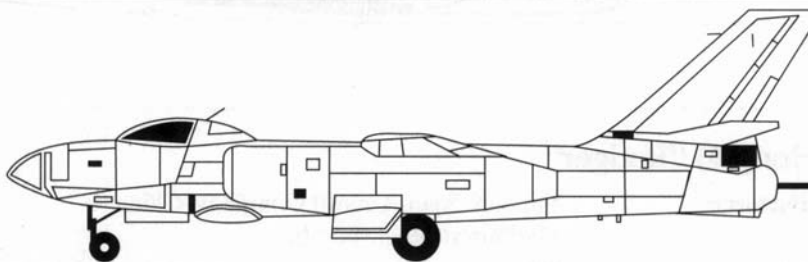


HARRIER JUMP JET

THE HONG KONG CAMPAIGN

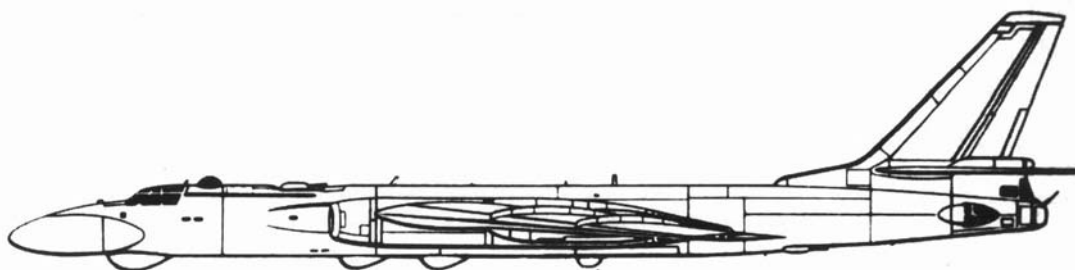
Intelligence Files

Chinese Aircraft

**Harbin H-5 (Hong-5) "Beagle"**

| | |
|------------------------------------|------------------------------------------------------------------------------------------------------|
| Designer/Manufacturer: | Ilyushin/Harbin Aircraft Manufacturing Corporation, China |
| Role: | Tactical light bomber |
| Crew: | Three |
| Mission weight at take-off: | 21,200kg |
| Engines: | Two Klimov VK-1A turbojets, each rated at 5,952lb st |
| Range: | 2,400km |
| Ceiling: | 40,350ft |
| Maximum speed at 0ft: | 432 kts |
| Maximum speed at 14,760ft: | 487 kts |
| Armament: | Two 23mm cannon and 3,000kg of bombs. Some "Beagles" may be configured for nuclear weapons delivery. |
| Air-to-Air Radar Quality: | poor |

Notes: This Chinese-built version of the Soviet Ilyushin Il-28 which first flew in 1948 entered production in China in 1966 as the Harbin H-5. Some 500 of the shoulder-wing twin-jet H-5 "Beagle" are believed to equip the air force of the People's Liberation Army. Variants include HJ-5 (Hongjiao-5) two-seat operational and pilot trainer version; HZ-5 (Hongzhen-5) three-seat tactical reconnaissance version.

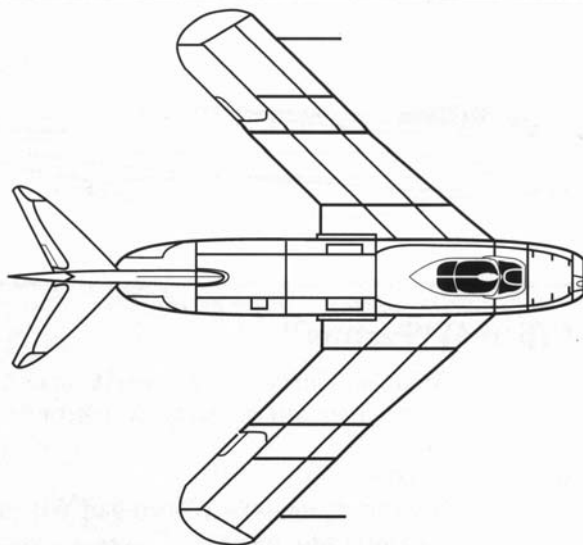


Xian H-6 (Hong-6) "Badger"

| | |
|------------------------------------|--------------------------------------------------------------------------------------------------------|
| Designer/Manufacturer: | Tupolev/Xian Aircraft Company, China |
| Role: | Medium strategic bomber |
| Crew: | Six |
| Mission weight at take-off: | 75,800kg |
| Engines: | Two Xian Wopen-8 turbojets rated at 20,944lb st |
| Range: | 4,300 km |
| Ceiling: | 39,370ft |
| Maximum cruising speed: | 424 kts |
| Armament: | (defensive) seven 23mm cannon; (offensive) up to 9,000kg of nuclear or conventional free-fall weapons. |

Notes: This unlicensed Chinese copy of the Soviet Tupolev Tu-16 "Badger," known as the Xian H-6, entered service with the Chinese air force in 1968 and 120 are now in service. The current version is designated H-6IV or B-6D, the Chinese equivalent of the Soviet "Badger-C/G", with two underwing C-ASM cruise missiles or two Chinese-copy C-601 "Styx" air-launched anti-shiping missiles. There is the possibility that ECM, reconnaissance and tanker variants may be developed in the future.

HARRIER JUMP JET



Shenyang J-5 "Fresco"

| | |
|-------------------------------|---------------------------------------------------------------------------------------------------------------------------------|
| Designer/Manufacturer: | Mikoyan-Gurevich/Shenyang Aircraft Company, China |
| Role: | All-weather fighter and fighter-bomber |
| Crew: | One |
| Engine: | One Klimov VK-1A turbojet rated at 7,605lb st with reheat |
| Range: | 1,400km |
| Ceiling: | 54,460ft |
| Maximum speed: | 617kts |
| Armament: | One 37mm and two 23mm cannon, or three 23mm cannon; four underwing 55mm air-to-air rocket packs; or 500kg of bombs under wings. |

Notes: The J-5 is the Chinese license-built version of the Soviet MiG-17PF "Fresco-D" single-seat subsonic interceptor which first flew in the USSR in 1950.

Local Chinese production of the type was almost fully established by 1959 and Chinese versions of the VK-1 engine were built at Harbin. Soviet production alone of the MiG-17 series was in the region of 6,000 aircraft. Although hopelessly outdated and outclassed today, some 300 examples of the J-5 are still in service with the Air Force of the People's Liberation Army, and several hundred more with the Aviation of the People's Navy, operating in the fighter-bomber role.



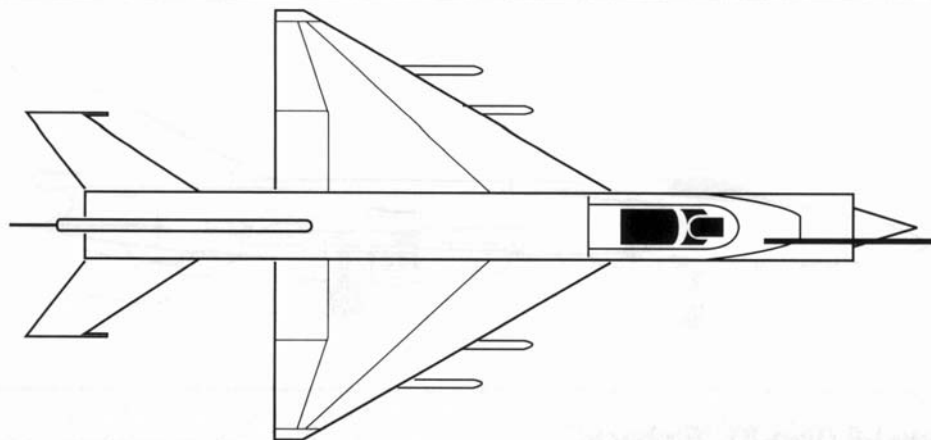
Shenyang/Tianjin J-6 (Jian-6) "Farmer"

| | |
|-----------------------------------|--------------------------------------------------------------------------------------------------------------------------|
| Designer/Manufacturer: | Mikoyan-Gurevich/Shenyang Aircraft Company, China |
| Role: | Day fighter, attack and tactical reconnaissance aircraft |
| Crew: | One |
| Mission Weight at Takeoff: | 10,000kg |
| Engines: | Two Shenyang-built Wopen-6 or WP-6 turbojets each rated at 7,165lb st with reheat |
| Maximum Range: | 2,200 km |
| Ceiling: | 65,190ft |
| Maximum Speed at 36,000ft: | 831kts |
| Armament: | Three 30mm cannon, two Harbin-built AIM-9B Sidewinder AAMs, twin air-air rocket packs, or four K-5M ("Alkali"-type) AAMs |

Notes: The J-6 and its variants are the unlicensed Chinese versions of the Soviet MiG-19S/PF/R "Farmer-C/D" fighter which first flew in 1961 and from the following year became the standard fighter aircraft of the Air Force of the People's Liberation Army. Seven different versions are known to have been produced and some 3,000 are believed to be still in service for air-to-air interception, battlefield interdiction, close support and tactical reconnaissance missions.

(Pic ref: Jane's World Combat Aircraft p19)

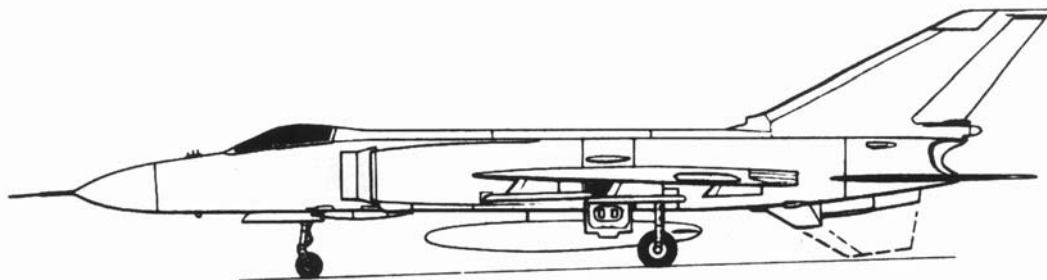
HARRIER JUMP JET

**Xian J-7 (Jian-7) "Fishbed"**

| | |
|-----------------------------------|--------------------------------------------------------------------------------------------|
| Designer/Manufacturer: | Mikoyan-Gurevich/Xian Aircraft Company, China |
| Role: | Day fighter and close-support aircraft |
| Crew: | One |
| Mission Weight at Takeoff: | 7,531kg |
| Engine: | One Chengdu Wopen-7B turbojet rated at 13,448lb st with reheat |
| Maximum Range: | 1,740km |
| Ceiling: | 62,990ft |
| Maximum Speed at 60,000ft: | 1,175kts (Mach 2.05) |
| Armament: | Two 30mm cannon, two PL-2 ("Atoll"-type) IR AAMs, two 57mm rocket pods, or two 150kg bombs |

Notes: This unlicensed Chinese copy of the Soviet MiG-21F "Fishbed-C" day fighter first flew in 1964. Earlier versions of the J-7 suffered from short endurance and inadequate air-to-air firepower. Major improvements in these areas plus enhanced handling characteristics were incorporated into the J-7 II version in the 1980s.

Typical mission profiles are CAP at 36,000ft with two AAMs and three 500-litre drop tanks; long range interception (650km), stores as above; Hi-lo-hi interdiction (600km) out and back at 36,000ft with three 500-litre drop tanks and two 150kg bombs; Lo-lo-lo close air-support (370km) with four rocket pods, no drop tanks.

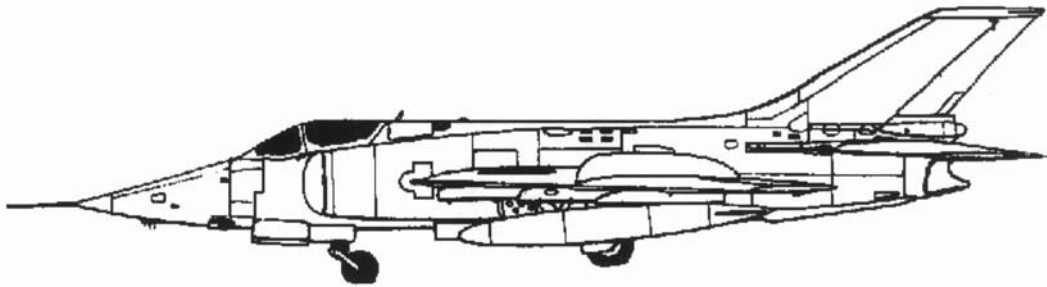


Shenyang J-8 (Jian-8) "Finback"

| | |
|-----------------------------------|---------------------------------------------------------------------------------------------------------------------------------------------------------------------|
| Designer/Manufacturer: | Shenyang Aircraft Company, China |
| Role: | Air superiority fighter, ground attack aircraft |
| Crew: | One |
| Mission Weight at Takeoff: | 17,800kg |
| Engines: | Two Wopen-13A II turbojets each rated at 14,815lb st with reheat |
| Maximum Range: | 2,200km |
| Ceiling: | 65,620ft |
| Maximum Level Speed: | 701kts |
| Maximum Operating Speed: | Mach 2.2 |
| Armament: | One 23mm twin-barrel cannon, up to six PL-2B IR AAMs, PL-4 radar-guided AAMs, PL-7 radar-homing AAMs, Type 57-2 unguided 57mm rocket pods, 90mm AS rockets, bombs . |

Notes: The J-8 first flew in the late 1960s and closely resembled the Soviet Mikoyan Ye-152A "Flipper". Some 50 examples of the J-8 I were built and an improved version incorporating uprated engines and modern AI radar and avionics, designated J-8 II, first flew in the mid-1980s.

HARRIER JUMP JET



Nanchang Q-5 (Qiang-5) "Fantan"

| | |
|-----------------------------------------|-----------------------------------------------------------------------------------------|
| Designer/Manufacturer: | Mikoyan-Gurevich/Nanchang Aircraft Manufacturing Company, China |
| Role: | Close air-support/ground attack |
| Crew: | One |
| Mission Weight at Takeoff: | 12,000kg |
| Engines: | Two Shenyang Wopen-6 turbojets each rated at 7,165lb st with reheat |
| Maximum Range: | 2,000km |
| Ceiling: | 52,000ft |
| Maximum Level Speed at 36,000ft: | 643kts (Mach 1.12) |
| Maximum Design Speed: | Mach 1.5 |
| Armament: | Two 23mm cannon, bombs, CBU's, unguided rocket pods, AAMs ("Atoll"-type or Sidewinder). |

Notes: Derived from the Soviet MiG-19 "Farmer" and the unlicensed Shenyang J-6, the Q-5 first flew in 1965. The current version is the Q-5III, some 600 of which are in service in China, with about 100 operating in the air defence role with the Aviation of the People's Navy. At the time of writing two parallel upgrade programmes are nearing completion: the A-5K relates to the Q-5III and incorporates a Thomson-CSF nav/attack system including HUD and laser ranger, and a SAGEM INS. The other programme, A-5M, is intended primarily for the A-5 export version of the "Fantan".



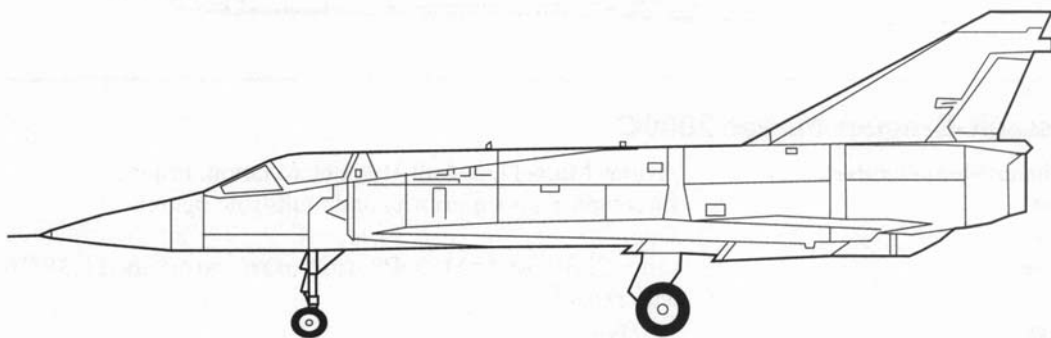
**THE
FALKLANDS
CAMPAIGN**

HARRIER JUMP JET

THE FALKLANDS CAMPAIGN

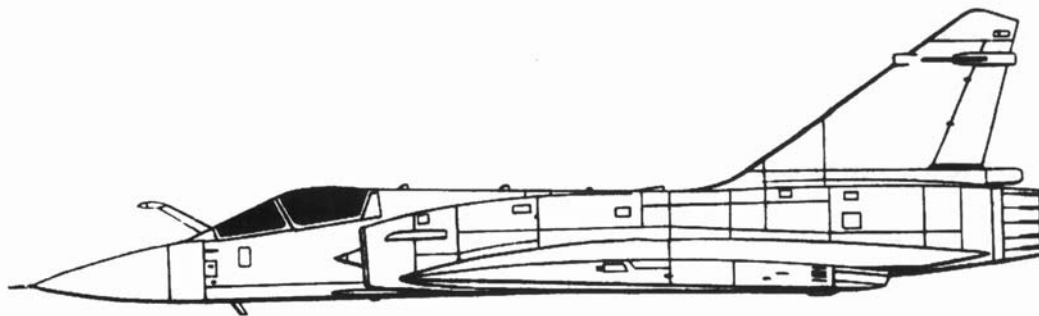
Intelligence Report

Argentinean Aircraft

**Mirage IIIEA**

| | |
|---------------------|---------------------|
| Weight: | 8.4 tons |
| Main Gun: | 2x 30mm DEFA 5 |
| Crew/Pass: | 1(2)/0 |
| Missiles: | Matra R.530, AIM-9B |
| Engines: | 13,670 lbs st |
| Speed: | 800 kts |
| Weapon Load: | 1.5 tons |

Notes: The Mirage III series was designed in the mid-1950s as a high speed interceptor. Due to the success achieved by Israeli pilots, the Mirage was sold to numerous Third World customers. The delta wing allows for high straight-line speed but gives the aircraft poor manoeuvrability in combat.

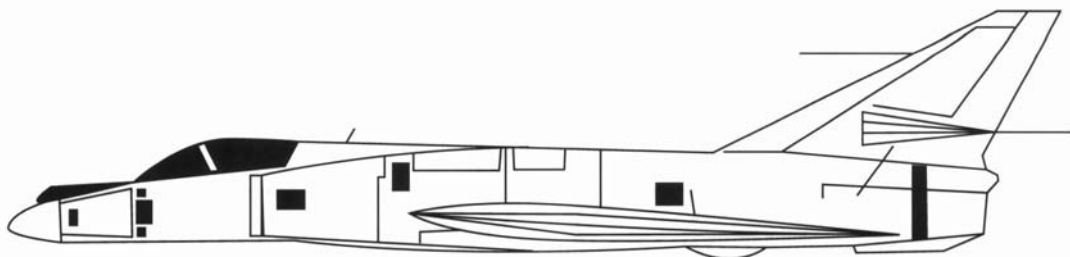


Dassault-Breguet Mirage 2000C

| | |
|-----------------------------------|------------------------------------------------------------------------------------------------------|
| Designer/Manufacturer: | Avions Marcel Dassault-Breguet Aviation, France |
| Role: | Interceptor, air superiority and multi-role fighter |
| Crew: | One |
| Engine: | One SNECMA M53-P2 turbofan rated at 21,385lb st with reheat |
| Range: | 1,500km |
| Maximum Weight at Takeoff: | 17,000kg (37,480lb) |
| Ceiling: | 59,000ft |
| Armament: | Two 30mm cannon, two Matra Super 530 AAMs and two MATRA 550 Magic IR AAMs (interception role) |
| Radar: | Thomson-CSF RDM multi-mode or RDI pulse-Doppler air-to-air radar, each with operating range of 100km |

Notes: Similar in appearance to the earlier Mirage III and 5 which equipped the Fuerza Aerea Argentina (FAA) during the Falklands war, the Mirage 2000 is in fact a high-tech fly-by-wire successor sharing little commonality with its predecessors. Because of the aerodynamic properties of its delta wing the Mirage 2000C is unsuited to the long-range high-speed role at low level, but more suited to the medium/high-altitude role, engaging targets flying at higher or lower altitudes with its AAMs.

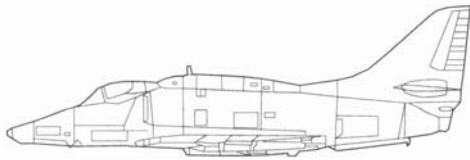
HARRIER JUMP JET



Dassault-Breguet Super Etendard

| | |
|-----------------------------------|-------------------------------------------------------------------------------------------------------------|
| Designer/manufacturer: | Avions Marcel Dassault-Breguet Aviation |
| Role: | Transonic carrier-based strike fighter |
| Crew: | One |
| Engine: | One SNECMA Atar 8K-50 non-afterburning turbojet rated at 11,025lb st |
| Maximum Weight at Takeoff: | 12,000kg |
| Range: | 850km |
| Ceiling: | 45,000ft |
| Maximum Speed at Height: | approx Mach 1 |
| Armament: | Two 30mm cannon, two MATRA R550 AAMs or four MATRA 155 68mm rocket pods; one AM39 Exocet ASM, two AS30 ASMs |
| Radar: | Thomson-CSF Anemone multi-mode radar |

Notes: Conceived as a low-cost lightweight single engined interceptor and ground-attack aircraft, the Etendard was further developed as the Super Etendard with improved handling, a more powerful engine and enhanced avionics. A Super Etendard of the Armada Argentina destroyed HMS Sheffield with an Exocet missile on 4 May 1982 during the Falklands war.



A-4P Skyhawk

| | |
|---------------------|---------------------|
| Weight: | 11.0 tons |
| Main Gun: | 2x 20mm Mk.12 |
| Crew/Pass: | 1/0 |
| Missiles: | AIM-9, AGM-Maverick |
| Engines: | 9300 lbs st |
| Speed: | 560 kts |
| Weapon Load: | 4.1 tons |

The Skyhawk was used extensively by Argentina in 1982 during the first Malvinas conflict. Using Hi-Lo-Hi flight profiles to conserve fuel, A-4Qs were able to score numerous hits on British warships using unguided Mk 82 500lb bombs.

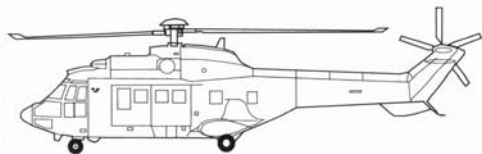


Bell UH-1 Iroquois "Huey"

| | |
|-------------------|--------------|
| Weight: | 4.7 tons |
| Main Gun: | None |
| Crew/Pass: | 3/15 |
| Missiles: | None |
| Engines: | 1,400 shp |
| Sec Gun: | 1x 7.62mm MG |
| Speed: | 110 kts |
| Armour: | None |

The Bell "Huey" is the most widely used family of helicopters in military aviation. The UH-1 is a standard assault transport, relying on a single side mounted machine gun to suppress enemy fire in the landing area. First used in Vietnam, the UH-1 proved the effectiveness of air mobility in warfare.

HARRIER JUMP JET

**PUMA SA330L**

| | |
|-------------------|-----------------------|
| Weight: | 5.9 tons Main |
| Gun: | 1x 7.62mm MG |
| Crew/Pass: | 2/21 |
| Missiles: | AM39 Exocet, AS. 15TT |
| Engines: | 2780 shp |
| Sec Gun: | None |
| Speed: | 150 kts |
| Armour: | None |

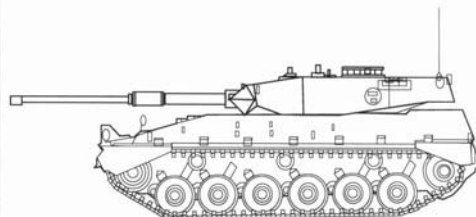
The Aerospatiale Super Puma is a significant improvement over the older SA 330 Puma. It has increased crash worthiness and newer fuel efficient turboshaft engines. The M version features a stretched cabin which can hold up to 25 soldiers along with gear.

Argentinean Tanks and APCs

**Jagdpanzer SK 105**

| | |
|-------------------|---------------|
| Weight: | 17.7 tons |
| Main Gun: | SK 105mm |
| Crew/Pass: | 3/0 |
| Missiles: | None |
| Engine: | 320 hp Diesel |
| Sec Gun: | 2x 7.62 MGs |
| Speed: | 65 KPH |
| Armour: | Light |

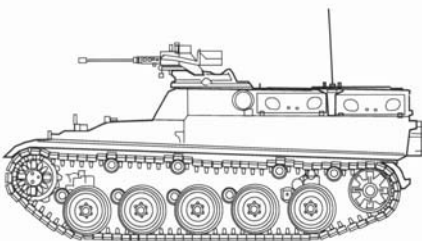
This Austrian-made light tank is based on a low silhouette Saurer APC chassis and can withstand frontal hits from up to 20mm ammunition. The conical turret houses a laser range finder and is similar in appearance to the AMX-13. There are almost 200 of these vehicles currently in service with Argentina.

**TAM**

| | |
|-------------------|---------------|
| Weight: | 32.5 tons |
| Main Gun: | 105mm L7A3 |
| Crew/Pass: | 4/0 |
| Missiles: | None |
| Engine: | 740 hp Diesel |
| Sec Gun: | 2x 7.62mm MG |
| Speed: | 75 KPH |
| Armour: | Medium |

The TAM (Tanque Argentino Mediano) is produced in Argentina under a West German licensing agreement. It has a sloped turret placed well to the rear of a Marder MICV chassis. A turret mounted 7.62mm MG is the vehicle's sole means of air defense. The TAM is the main battle tank of the Argentinean armoured corps.

HARRIER JUMP JET

**AMX VCI**

| | |
|-------------------|---------------|
| Weight: | 16.5 tons |
| Main Gun: | 1x 12.7mm MG |
| Crew/Pass: | 3/10 |
| Missiles: | None |
| Engine: | 280 hp Diesel |
| Sec Gun: | None |
| Speed: | 65 kph |
| Armour: | Light |

The AMX-VTP has recently been redesignated AMX-VCI (Vehicule Combat d'Infanterie). The VTP suffers from a lack of amphibious capability and egress ramp. Passengers must exit through two rear doors. Although the VTP is still being produced in Argentina, most of these vehicles are being gradually phased out.



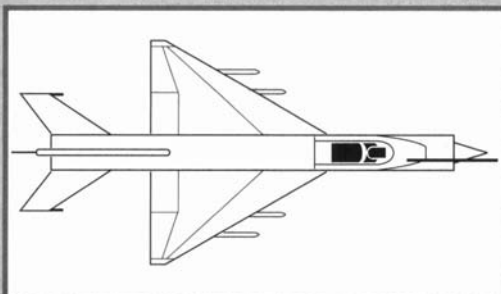
**THE
NORDKAPP
CAMPAIGN**

HARRIER JUMP JET

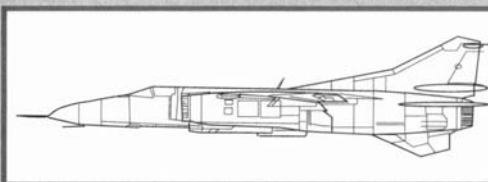
THE NORDKAPP CAMPAIGN

Intelligence Files

Russian Aircraft

**MiG-21 Fishbed**

The Mig-21 is an adaptable design and built to be capable of constant upgrade. Originally in service in 1957, it is still seen as a major threat with its new engine and radar. It cannot be compared in performance to modern aircraft but is extremely dangerous at low speeds. Any combat above 0.9 Mach makes it very vulnerable.

**MiG-23 Flogger**

| | |
|---------------------|----------------------|
| Weight: | 17.8 tons |
| Main Gun: | 23mm, 200 rds |
| Crew/Pass: | 1/0 |
| Missiles: | Kerry, Aphid, Apex |
| Engines: | Two AB 27,500 lbs st |
| Max Speed: | 729 kts |
| Weapon Load: | 3 tons |

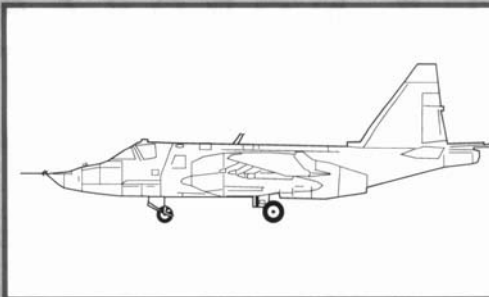
The Flogger variable-geometry interceptor was first issued to Soviet tactical air forces in 1973. Once there, it gradually replaced the ageing MiG-21. Although it provides the basic airframe for the newer MiG-27, the Flogger is nearing the end of its usefulness. Built in huge numbers in the 70's, this swing-wing fighter was relatively cheap and easy to produce. It has high performance capabilities carrying up to 8 AAMs at speeds over Mach 2. The radar and missile system has a long distance detection and engagement range than the F-16. When pitched against modern fighters it is at its best keeping its distance and using its missiles.



MiG-29 Fulcrum

| | |
|---------------------|----------------------|
| Weight: | 18 tons |
| Main Gun: | 30mm, 150 rds |
| Crew/Pass: | 1/0 |
| Missiles: | Kerry, Alamo, Archer |
| Engines: | two AB 18,300 lbs st |
| Max Speed: | 702 kts |
| Weapon Load: | 4 tons |

Operational since 1985, the Fulcrum is comparable in size to the U.S. F/A-18 Hornet. The last of the great generation of Soviet built aircraft using all the avionics available in the early 90s. Extremely manoeuvrable, its look-down, shoot-down radar can detect and lock-on targets beyond visual range and guide the latest air-to-air missiles onto those targets. The Mig-29 can also carry a huge load of ordnance for ground attack.

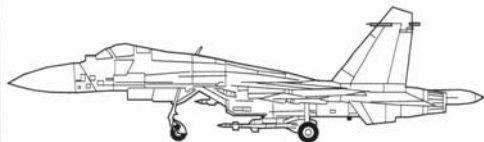


Sukhoi SU-25 Frogfoot

| | |
|---------------------|---------------------------------|
| Weight: | 17.6 tons |
| Main Gun: | 30mm, 250 rds |
| Crew/Pass: | 1/0 |
| Missiles: | LGBs, rockets, Aphid, Atolls |
| Engine: | two 9,921 lbs st |
| Max Speed: | 526 kts |
| Weapon Load: | 4.4 tons |

Often considered the Soviet equivalent of the A-10, the Frogfoot entered service in 1984. Equipped with a titanium bathtub cockpit and foam filled fuel tanks, it was designed with similar survivability in mind. The Su-25 is considerably faster than its US counterpart.

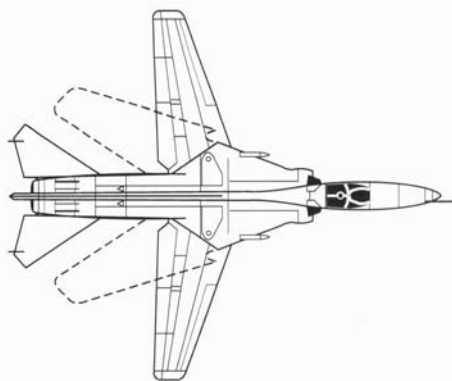
HARRIER JUMP JET



Sukhoi SU-27 Flanker

| | |
|---------------------|-------------------------------|
| Weight: | 28 tons |
| Main Gun: | 30mm, 149 rds |
| Crew/Pass: | 1/0 |
| Missiles: | Alamo, Aphid, Archer, Amos |
| Engine: | one AB 27,557 lbs st |
| Max Speed: | 726 kts |
| Weapon Load: | 8 tons |

The Soviet Flanker entered service in the mid-1980s after a difficult developmental period. It was designed to compete with US F-14s and F-15s. The Su-27 is much larger than a MiG-29 but is similarly equipped. It has been configured for carrier operations but is unlikely to see much action in that role.



MiG-27 Flogger

| | |
|-----------------------|------------------------------------------------------|
| Designer: | Mikoyan-Gurevich, USSR |
| Role: | Single-seat strike fighter |
| Weight: | 22 tons |
| Engine(s): | One Tumansky R-29 turbofan; 25,353 lbs thrust |
| Range: | 400 kilometres |
| Ceiling: | 52,500' |
| Max Speed: | 925 kts |
| Armament: | One 23mm cannon, 5 weapon pylons, 2 bomb racks |
| Radar Quality: | Very poor, very short-range pulse radar |



Sukhoi SU-24 Fencer

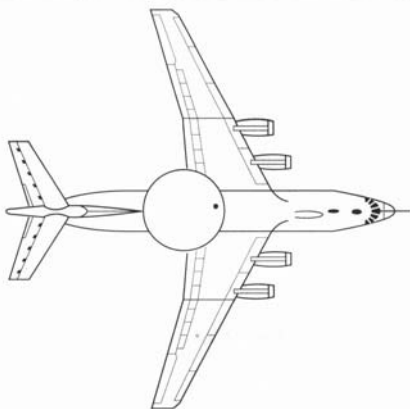
| | |
|-----------------------|----------------------------------------------------------------|
| Designer: | Sukhoi, USSR |
| Role: | Double-seat strike fighter and interceptor |
| Weight: | 43.5 tons |
| Engine(s): | Two Tumansky R-29B turbofans; 50,700 lbs thrust |
| Range: | 300 to 1,800 kilometres (varies with mission profile and load) |
| Ceiling: | 57,400' |
| Max Speed: | 1400 kts |
| Armament: | 23mm cannon, 8 weapon pylons |
| Radar Quality: | Nil, avionics designed purely for air-to-ground role. |



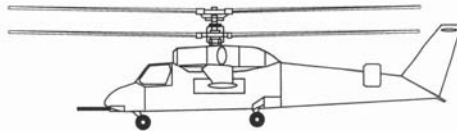
Tupelov TU-95 Bear

| | |
|-----------------------|--------------------------------------|
| Designer: | Tupelov, USSR |
| Role: | 7-12 man reconnaissance bomber |
| Weight: | unknown, about 145-165 tons |
| Engine(s): | Four Kuznetsov NK-12MV turbo props |
| Range: | 8,250 kilometres (7 hours endurance) |
| Ceiling: | 41,000' |
| Max Speed: | 475 kts |
| Armament: | Unarmed |
| Radar Quality: | Very good long-range pulse radar |

HARRIER JUMP JET

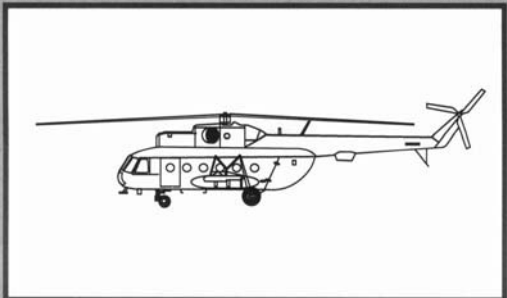
**Ilyushin IL-76 Mainstay**

| | |
|-----------------------|------------------------------------------------------|
| Designer: | Ilyushin, USSR |
| Role: | 15-20 man AEW&C |
| Weight: | About 150 tons |
| Engine(s): | Four Soloviev D-30KP turbofans; 106,000 lbs thrust |
| Range: | About 6,400 kilometres (7 hours endurance) |
| Ceiling: | About 40-50,000' |
| Max Speed: | 460 kts |
| Armament: | Possibly twin 23mm tail cannon, 2-4 weapon pylons |
| Radar Quality: | Excellent long-range Doppler radar |

**Kamov Ka-34 Hokum**

| | |
|---------------------|-----------------------------------|
| Weight: | 7.5 tons |
| Main Gun: | 30mm, 300 rds |
| Crew/Pass: | 2/0 |
| Missiles: | Spiral ATGM Rockets, SA-14 AAM |
| Engine: | two 2,200 shp |
| Max Speed: | 190 kts |
| Weapon Load: | 2.3 tons |

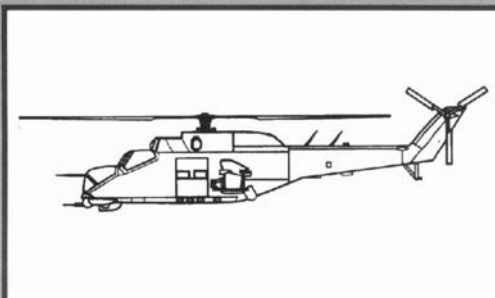
By 1990, the Soviet Hokum was still in the testing stage. The exact role of the helicopter is not yet known. Kamov (Ka) helicopters have always been produced mainly for maritime roles. It may be intended for amphibious assault escort or anti-helicopter combat. It has a distinctive Kamov mark of contra-rotating rotors.



MIL Mi-8 HIP

| | |
|---------------------|---------------------|
| Weight: | 11.2 tons |
| Main Gun: | 12.7mm |
| Crew/Pass: | 2/28 |
| Missiles: | Spiral ATGM Rockets |
| Engine: | two 1,700 shp |
| Max Speed: | 130 kts |
| Weapon Load: | 3 tons |

When it first appeared in 1961, the Soviet Hip was a simple, quasi-military transport helicopter. After years of modifications, the Hip has evolved into one of the most widely accepted military helicopters with over 10,000 in use. It's described as the most heavily armed assault helicopter.

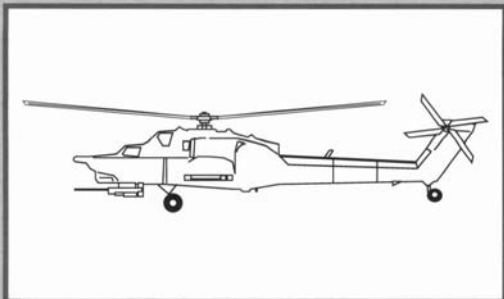


MIL Mi-24 HIND

| | |
|---------------------|----------------------------------|
| Weight: | 12 tons |
| Main Gun: | 12.7mm |
| Crew/Pass: | 2/8 |
| Missiles: | Spiral ATGM Rockets, SA-7 AAM |
| Engine: | two 2,200 shp |
| Max Speed: | 295 kts |
| Weapon Load: | 2.4 tons |

The Soviet Hind first appeared in 1972. It was originally designed as a heavily-armed assault helicopter, but has evolved into a capable gunship. It lacks the nap-of-the-earth manoeuvrability of its western counterparts. Still, it carries a heavy load, and has retained its transport capacity.

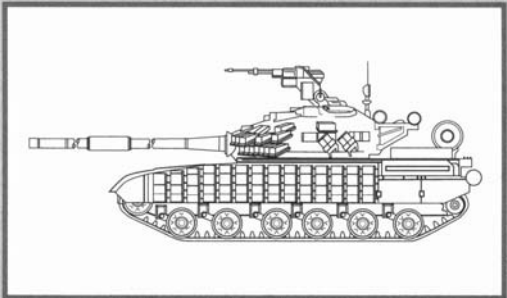
HARRIER JUMP JET

**MIL Mi-28 HAVOC**

| | |
|---------------------|-----------------------------------|
| Weight: | 11.4 tons |
| Main Gun: | 30mm, 300 rds |
| Crew/Pass: | 2/0 |
| Missiles: | Spiral ATGM Rockets, SA-14 AAM |
| Engine: | two 2,200 shp |
| Max Speed: | 165 kts |
| Weapon Load: | 3 tons |

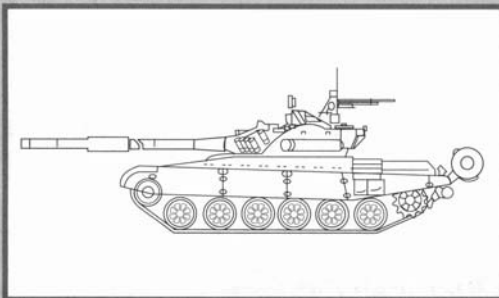
Often described as the Soviet Apache, the Havoc completed pre-production testing in 1989. A true gunship, as opposed to the Hind's hybrid approach, the Havoc's narrow silhouette and tandem seating are much more suited to its role. Its high speed agility has also been enhanced by a new rotor structure.

Russian Tanks, APCs

**T-64B Main Battle Tank**

| | |
|-------------------|------------------|
| Weight: | 42 tons |
| Main Gun: | 125mm SB, 42 rds |
| Crew/Pass: | 3/0 |
| Missiles: | Songster, 2rds |
| Engine: | 750 hp diesel |
| Sec Gun: | two MG's |
| Max Speed: | 75 kph |
| Armour: | Heavy |

The original Soviet T-64's entered service in 1967, and were plagued with autoloader and engine problems. The "B" model seems to have corrected these problems since it's still in production. It appears the T-64's were the "high-tech" option while the T-72's embodied the "bargain-basement" approach.

**T-72MI Main Battle Tank**

| | |
|-------------------|------------------|
| Weight: | 41 tons |
| Main Gun: | 125mm SB, 39 rds |
| Crew/Pass: | 3/0 |
| Missiles: | None |
| Engine: | 780 hp diesel |
| Sec Gun: | two MG's |
| Max Speed: | 80 kph |
| Armour: | Heavy |

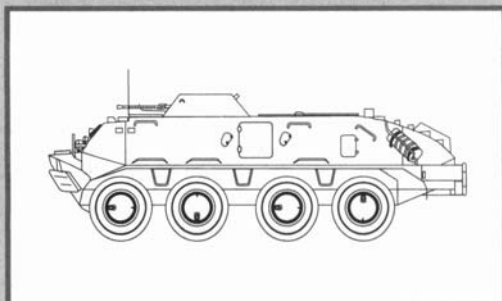
The Soviet T-72 followed shortly after the T-64, entering service in 1971. The T-72 series has had a long career, and has been exported to many nations. Over a dozen sub-models have been identified to date. This model features enhanced turret armour, resulting in the nickname "Dolly Parton".

HARRIER JUMP JET

**T-80A Main Battle Tank**

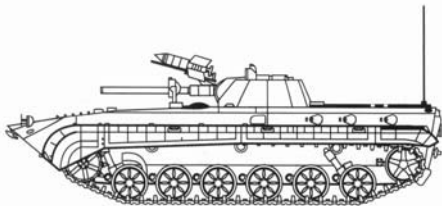
| | |
|-------------------|------------------|
| Weight: | 42 tons |
| Main Gun: | 125mm SB, 42 rds |
| Crew/Pass: | 3/0 |
| Missiles: | Songster, 2 rds |
| Engine: | 980 hp turbine |
| Sec Gun: | two MG's |
| Max Speed: | 75 kph |
| Armour: | Heavy |

The Soviet T-80A is thought to have entered service in 1983. It has closer developmental ties to the T-64 then to the T-72. It's considered to be only an evolutionary design, although, the gas turbine engine is a radical departure. The AT-8 Songster was added to provide long range capability, as the 125mm SB's accuracy is poor.

**BTR-60/70/80****Armoured Personnel Carrier**

| | |
|-------------------|-----------------|
| Weight: | 10.5 tons |
| Main Gun: | 14.5mm, 500 rds |
| Crew/Pass: | 2/12 |
| Missiles: | None |
| Engine: | 260 hp diesel |
| Sec Gun: | one MG |
| Max Speed: | 80 kph |
| Armour: | Light |

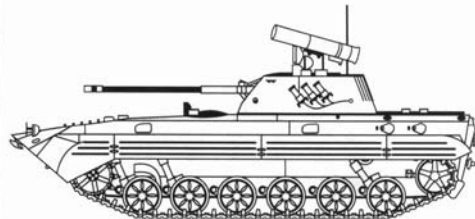
The first version of this Soviet APC, the BTR-60, entered service in 1960. These vehicles are rather mediocre in all respects. The later models did overcome a number of flaws; and the BTR-80 (data is for this vehicle) did replace the volatile petrol engines.



BMP-1 Infantry Fighting Vehicle

| | |
|-------------------|-----------------|
| Weight: | 13.9 tons |
| Main Gun: | 73mm SB, 40 rds |
| Crew/Pass: | 3/8 |
| Missiles: | Sagger, 5 rds |
| Engine: | 300 hp diesel |
| Sec Gun: | one MG |
| Max Speed: | 70 kph |
| Armour: | Light |

The Soviet BMP-1 caused quite a stir when it entered service in 1967. This revolutionary design was the first to combine cannon, ATGM and a full infantry squad under armour file capability. Its 73mm gun has poor long range accuracy, and the one-man turret is inefficient.

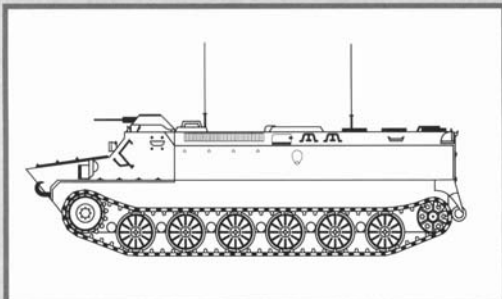


BMP-2 Infantry Fighting Vehicle

| | |
|-------------------|----------------|
| Weight: | 14.6 tons |
| Main Gun: | 30mm, 500 rds |
| Crew/Pass: | 3/7 |
| Missiles: | Spandrel, 5rds |
| Engine: | 400 hp diesel |
| Sec Gun: | one MG |
| Max Speed: | 65 kph |
| Armour: | Light |

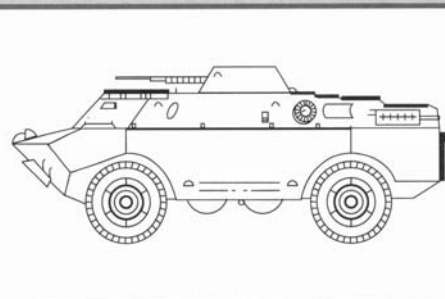
The BMP-2 is an upgrade of the Soviet BMP-1, and probably entered service around 1980. It saw the poor 73mm gun replaced with a high-velocity 30mm auto-cannon. The commander was moved from the hull to the turret, improving labour distribution and vision. The Sagger missile was replaced with the longer-ranged Spandrel.

HARRIER JUMP JET

**MT-LB Armoured Personnel**

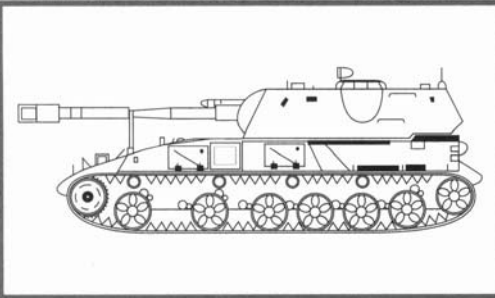
| | |
|-------------------|---------------|
| Weight: | 9.7 tons |
| Main Gun: | 7.62mm MG |
| Crew/Pass: | 2/10 |
| Missiles: | None |
| Engine: | 240 hp diesel |
| Sec Gun: | one |
| Max Speed: | 62 kph |
| Armour: | Light |

The Soviet MT-LB design closely followed the MT-L Arctic tractor. This accounts for its excellent cross-country performance. Typical roles for the MT-LB include artillery prime mover, command post and cargo carrier. Its chassis is also the basis for a number of other vehicles.

**BRDM-2 Reconnaissance Vehicle**

| | |
|-------------------|-----------------|
| Weight: | 7.0 tons |
| Main Gun: | 14.5mm, 500 rds |
| Crew/Pass: | 2/3 |
| Missiles: | None |
| Engine: | 140 hp petrol |
| Sec Gun: | one MG |
| Speed: | 100 kph |
| Armour: | Light |

The Soviet BRDM-2 replaced its predecessor, the BRDM-1, in the mid-1960s. It's also used as a command or an observer vehicle. It has become outclassed by more modern vehicles, and its 14.5mm gun is outdated and inadequate.



152mm SO-152 Self-Propelled Heavy Artillery

- Weight:** 27.5 tonnes
Main Gun: 152mm gun/howitzer
Crew/Pass: 4/0
Engine: 520 hp diesel
Max. Speed: 50 kmph
Night Gunsight: White/IR Searchlight

Built on the same chassis as the SA-4 missile carrier, this heavy artillery vehicle started replacing towed guns in the middle 1970s. The 152mm gun has a mechanical loader that requires minimal human assistance. Crewmen outside the vehicle can replenish the loader even as the gun is firing.

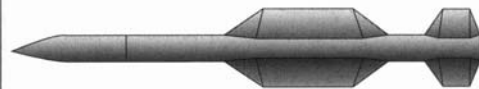
HARRIER JUMP JET

Russian AA & SAMs

**SA-10 Grumble SAM**

| | |
|--------------------------|-------------------------------------------------|
| Search System: | Phased-array Doppler radar |
| Max Search Range: | 320 kilometres |
| Guidance System: | Modern Doppler radar and command guidance |
| Max Firing Range: | 125 kilometres |
| Max Speed: | Mach 3 |
| Max Altitude: | 70,000'+ |
| Manoeuvrability: | Fair |

Long-range, fixed-site or mobile, radar-homing SAM. Radar bunker or armoured vehicle with missile emplacements or armoured vehicle missile launchers.

**SA-11 Gadfly SAM**

| | |
|--------------------------|---------------------------------------|
| Search System: | Modern Doppler radar |
| Max Search Range: | 200 kilometres |
| Guidance System: | Modern pulse radar, backup unknown |
| Max Firing Range: | 100 kilometres |
| Max Speed: | Mach 2.5 |
| Max Altitude: | 45,000'+ |
| Manoeuvrability: | Good |

Medium-range, mobile, radar-homing SAM. Radar and launcher on same vehicle.



SA-13 Gopher SAM

Short-range, vehicle mounted IR-homing SAM, radar and launcher carried on same armoured vehicle. Search range 30-60 km, maximum range 65 km, speed Mach 1.5 and maximum altitude 30,000 feet.

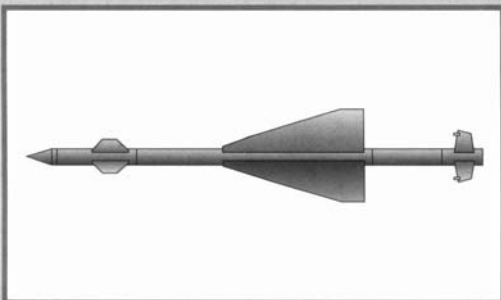


AA-8 "Aphid"

Short-range air-to-air missile with IR-homing.

| | |
|----------------------------------|------------------------------------------|
| Nation of | |
| Manufacture: | USSR |
| Guidance: | Early second generation IR-seeker |
| Effective Range: | 12 km |
| Missile Speed: | Mach 3 |
| Maneuverability: | Excellent |
| Attack Technique: | All-aspect lock on, then fire-and-forget |
| Nationality and Aircraft: | Soviet, most fighters |

HARRIER JUMP JET

**AA-7 "Apex" (Radar)**

Medium-range air-to-air missile with semi-active radar-homing.

Nation of

Manufacture: USSR

Guidance: Semi-active radar-homing (requires radar guidance from plane)

Effective Range: 34 km

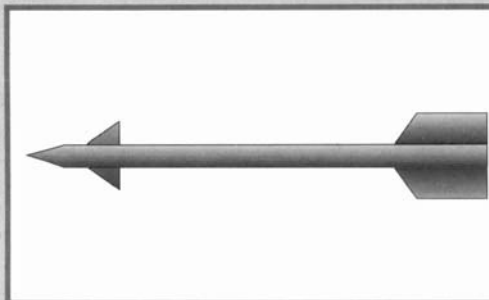
Missile Speed: Mach 3

Maneuverability: Poor

Attack Technique: Semi-active radar-guided from launching aircraft

Nationality and

Aircraft: Soviet and Warsaw Pact MiG-23s

**AA-10 "Alamo"**

Medium-range air-to-air missile with active radar-homing.

Nation of

Manufacture: USSR

Guidance: Active radar-homing (has its own radar in nose)

Effective Range: 64 km

Missile Speed: Mach 3+

Maneuverability: Good

Attack Technique: Active radar-homing independent of launching aircraft

Nationality and

Aircraft: Soviet MiG-29s and SU-27s

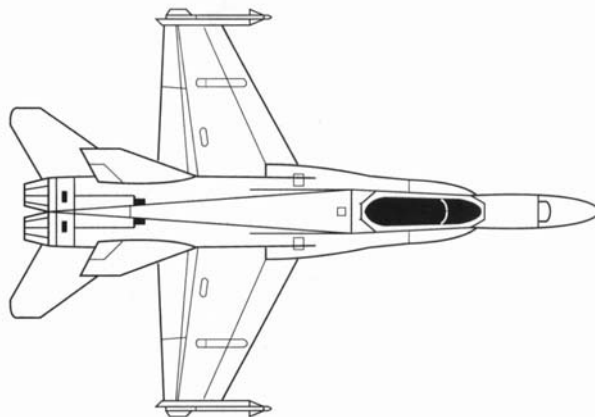


**INTELLIGENCE
FILE**

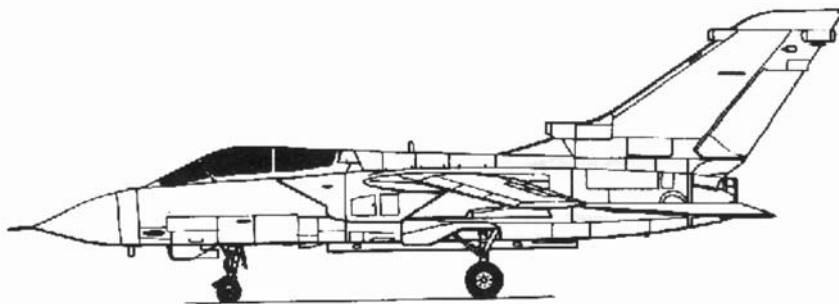
HARRIER JUMP JET

INTELLIGENCE FILE

UK and US Aircraft

**F/A-18C Hornet**

Designed by McDonnell Douglas/ Northrop, USA, the Hornet is basically a Single-seat fighter/strike fighter. Weighing 18 tons and powered by two GE F404-400 turbofans giving 32,000 lbs of thrust, its range is 740 km with a service ceiling of 50,000 feet. It has a 20mm cannon and 9 weapons pylons. Maximum speed is 1050 knots.

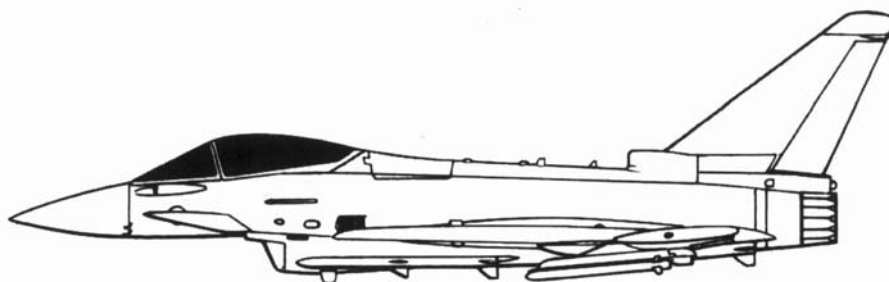


Panavia Tornado GR Mk 4

| | |
|-----------------------------------------|-------------------------------------------------------------------------------------------------------------------------------------------------------------------------------------------------------------------------------------------------------------------------|
| Designer/Manufacturer: | Panavia Aircraft GmbH/British Aerospace (UK), MBB (Germany), Aeritalia (Italy) |
| Role: | Interdictor/strike/reconnaissance |
| Crew: | Two |
| Mission Weight at Takeoff: | 27,215kg |
| Engines: | Two Turbo-Union RB199-34R Mk101 turbofans each rated at 16,000lb st with reheat |
| Range (with heavy weapons load): | 1,390km |
| Maximum Speed: | Mach 2.2 |
| Armament: | Two 27mm cannon, wide range of underfuselage and underwing stores and weapons including tactical nuclear, ALARM or HARM anti-radar missiles, bombs (including cluster, smart, retarded and fire), MW-1 munitions dispenser, anti-airfield weapons and rocket launchers. |
| Radar: | GEC terrain referenced navigating/terrain following radar, Marconi EW suite, Doppler radar, RWR. |

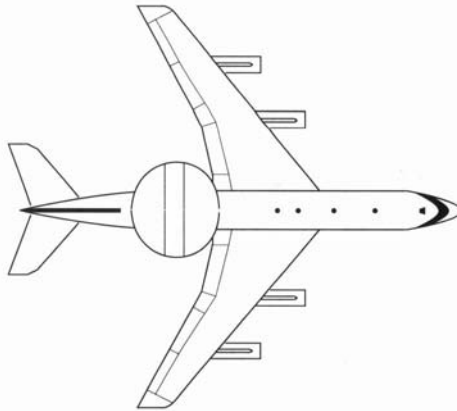
Notes: The Tornado IDS entered RAF service as the GR Mk1 and is the original all-weather multi-purpose variable geometry combat aircraft and features fly-by-wire controls. In RAF service the GR Mk1 achieved a high reputation for accurate attack at long range and very low level. The GR Mk1a is the tactical reconnaissance version equipped with sideways-looking IR, Linescan IR surveillance, and signal processing and video recording system. Both versions saw extensive use in the 1991 Gulf War. The GR4 version is the mid-life update of the GR1 and is expected to be superseded at the end of the century in the low-level high-speed strike role by the single-seat Tornado 2000.

HARRIER JUMP JET

**European Fighter Aircraft (EFA)**

| | |
|-----------------------------------|---------------------------------------------------------------------------------------------------------------------------------------------------------|
| Designer/Manufacturer: | Eurofighter Jagdflugzeug GmbH/British Aerospace (UK), MBB/Dornier (Germany), Alenia (Italy), CASA (Spain) |
| Role: | STOL fighter/ground attack |
| Crew: | One |
| Mission Weight at Takeoff: | 17,000kg Estimated (E) |
| Engines: | Two Eurojet EJ200 turbofans rated at 20,250lb st with reheat |
| Range: | 550km (E) |
| Ceiling: | 60,000ft (E) |
| Maximum Speed: | Mach 1.8 (E) |
| Armament: | One 27mm cannon, AIM-120 AMRAAM and short range AIM-132 ASRAAM or Sidewinder AAMs |
| Air-to-Air Radar: | Primary multi-mode pulse-Doppler radar capable of acquiring eight targets simultaneously, plus velocity and single-target search, and track-while-scan. |

Notes: EFA will be configured primarily for the air defence role but with a secondary air-to-surface attack capability and some 800 aircraft are expected to equip the air arms of Great Britain, Germany, Italy and Spain by the late 1990s. A full fly-by-wire flight control system and high-tech specification make EFA a highly manoeuvrable aircraft. A large proportion of the airframe will be made from composite materials which incorporate "stealth" characteristics.

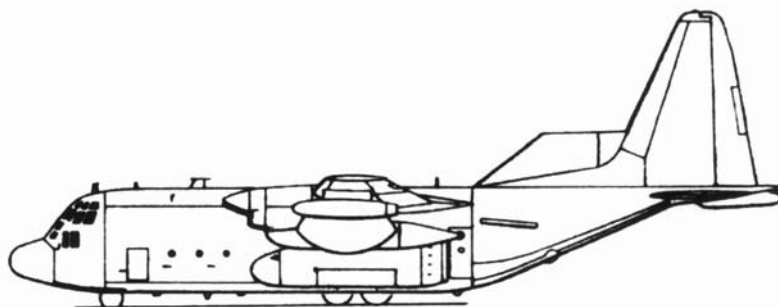


Boeing E-3D Sentry AEW Mk1

| | |
|---------------------------------------|----------------------------------------------------------------------------------|
| Designer/Manufacturer: | Boeing Aerospace Company, USA |
| Role: | Airborne Early Warning and Command Post |
| Crew: | 15-17 |
| Mission Weight at Takeoff: | 147,417kg |
| Engines: | Four CFM56-2A-3 turbofans rated at 22,000lb st each unheated |
| Range: | 1,610km (6hrs) |
| Maximum Unrefuelled Endurance: | 11hrs |
| Ceiling: | Over 29,000ft |
| Maximum Speed: | 460kts |
| Armament: | None. Weapons pylons may be added for defence |
| Radar: | Surveillance radar, communications, air traffic control, and electronic defences |

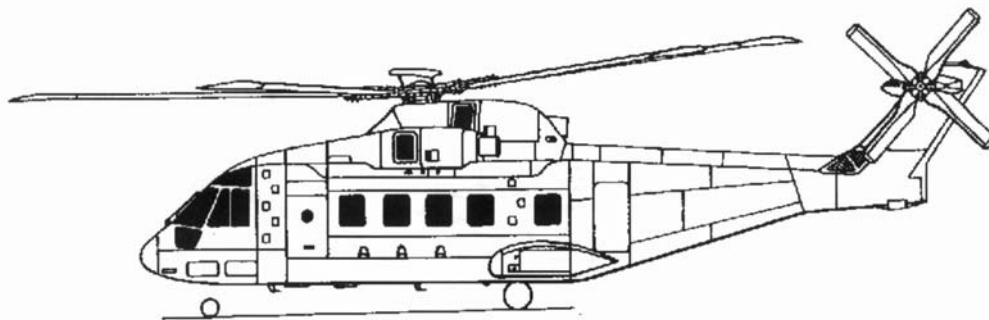
Notes: Surveillance radar and antennae in a saucer-shaped rotodome mounted above the fuselage rotates at six rpm to detect, track and identify aircraft and missiles flying at any altitude, in all weathers over any terrain. RAF aircraft have the Joint Tactical Information Distribution System (JTIDS) facility. The Sentry AEW1 also has a maritime surveillance capability, can direct friendly aircraft during air defence and strike missions, and can locate enemy ECM. The RAF operates seven aircraft in this role in the UK with No 8 Squadron from its base at Waddington in Lincolnshire.

HARRIER JUMP JET

**Lockheed C-130K Hercules CMk1**

| | |
|------------------------------------|-------------------------------------------------------------------------|
| Designer/Manufacturer: | Lockheed Corporation, USA |
| Role: | Tactical/strategic military transport/tanker |
| Crew: | 5 |
| Mission Weight at Takeoff: | 155,000lb |
| Engines: | Four Allison T56A-15 turboprops giving 4,508eshp |
| Range With 3,000lb Payload: | 2,950nm |
| Ceiling: | 20,000ft |
| Cruising Speed: | 315kts |
| Typical Maximum Loads: | 90 passengers/64 paratroops/78 stretchers/five pallets/ Puma helicopter |
| Armament: | None. Equipped with decoy flares |

Notes: The RAF operates 61 Hercules CMk1 and CMk3 aircraft from Lyneham in Wiltshire. The CMk3, of which there are 30, is a stretched version of the basic design, 15ft longer than the CMk1. Nos 24 and 30 Squadrons are involved in the air-to-air tanking role, whilst Nos 47 and 70 Squadrons are tasked with tactical support - the dropping of paratroops and supplies. The RAF's Hercules fleet played key roles in both the Falklands war in 1982 and the Gulf War of 1991, ferrying personnel, equipment and supplies.



EHI Merlin HAS Mk1

| | |
|-----------------------------------|----------------------------------------------------------------------------------------------|
| Designer/Manufacturer: | EHI Industries Ltd, UK/Westland (UK), Agusta (Italy) |
| Role: | Multi-role helicopter |
| Crew: | 2-4 |
| Mission Weight at Takeoff: | 13,530kg |
| Engines: | Rolls-Royce Turbomeca RTM 322 turboshafts each with a continuous rating of 1,437shp |
| Range: | 720 miles |
| Cruising Speed: | 160kts |
| Armament: | Four Stingray homing torpedoes, A-S missiles |
| Radar: | Various depending on role, e.g.: in ASW role - Ferranti Blue Kestrel 360-degree search radar |

Notes: The Merlin HAS Mk1 is the Royal Navy version of the EH101 helicopter and is capable of single-pilot operation, plus observer and acoustic systems operator. It is an extremely versatile helicopter and its primary roles are ASW, ASV, anti-ship surveillance/tracking, amphibious operations, SAR, AEW, vertrep and ECM.

HARRIER JUMP JET



Westland Lynx AH Mk9

Designer/
Manufacturer: Westland Helicopters, UK

Role: Multi-purpose helicopter

Crew: 2

MissionWeight
at Takeoff: 5,125kg

Engines: TwoRolls-Royce
Gem 41-2 turboshafts each
with a maximum rating
of 1,120shp

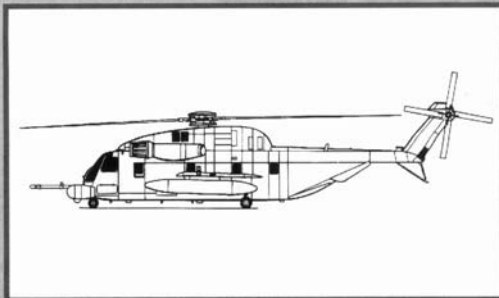
Range: 630km

Ceiling: 10,600ft

Cruising
Speed: 140kts

Armament: Two 20mm cannon
/7.62mm machine gun,
rocket pods, Euromissile
HOT and AGM-114
Hellfire anti-tank ASMs

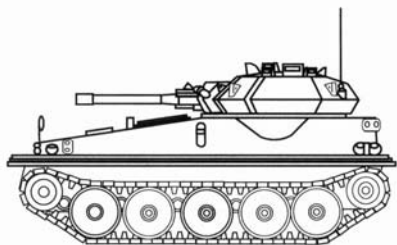
Notes: The Lynx AH Mk9 is the British Army Air Corps equivalent of the export Battlefield Lynx, fitted with tricycle undercarriage, advanced technology main rotors and exhaust diffusers, the latter to lower its IR signature and make it less vulnerable to heat seeking missiles.



CH-53E Super Stallion

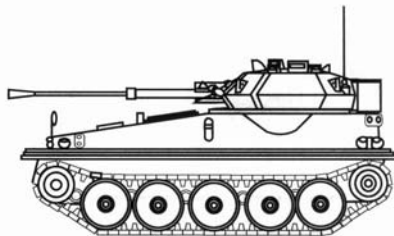
A conventional, long-range helicopter with twin turbo-shaft engines and all-metal main and tail rotors. In normal operations it can transport 38 combat equipped troops or 8,391 kg of freight.

US & UK Vehicles



Scorpion Light Tank

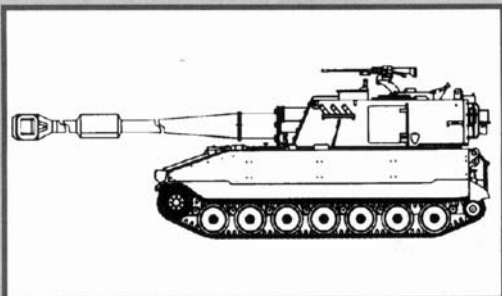
Excellent cross-country performance and high speed make this an ideal recon vehicle. Weight 8.1 tons with a crew of three and a max speed of 81 kmph the Scorpion has 76 mm main gun and carries 40 rounds but is only lightly armoured.



Scimitar Recon Vehicle

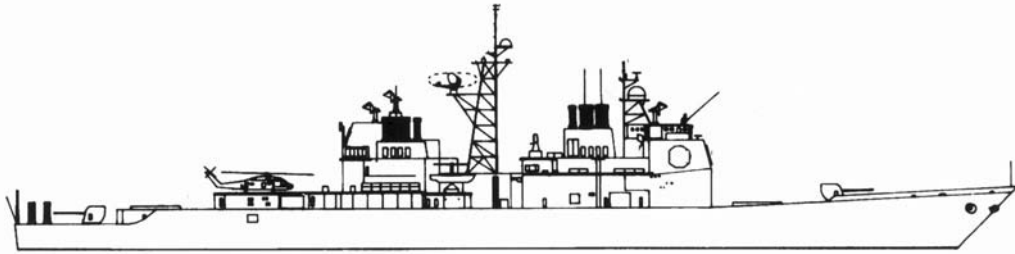
The Scimitar provides area and suppressive fire while still maintaining penetrative power to engage opposing light vehicles. Weight 7.8 tons with a crew of three and a max speed of 81 kmph, it has a 30mm main gun and carries 165 rounds but is only lightly armoured.

HARRIER JUMP JET

**M109 SPG**

Weight 24.9 tons with a crew of six and a max speed of 56 kmph the M109 has an 155mm main gun and carries 36 rounds but is only lightly armoured.

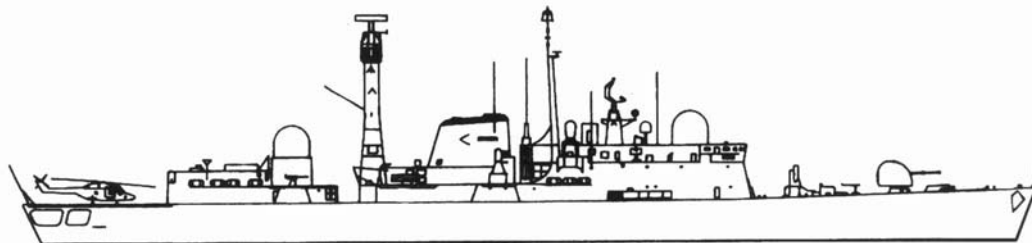
Allied Ships

**“Ticonderoga” Class Guided Missile Cruisers (USA)**

| | |
|----------------------|---------------------------------------------------------------------------------|
| Displacement: | 9,590 tons |
| Length: | 567ft |
| Propulsion: | Four General Electric GE LM2500 gas turbines giving 88,000hp through two shafts |
| Speed: | More than 30kts |
| Range: | 6,000 miles @ 20kts |
| Complement: | 358 |
| Missiles: | SLCM, SSM, SAM |
| Guns: | Two 5in, two 20mm, four 12.7mm |
| Torpedoes: | Six Mk32, 36 Mk46 |
| Helicopters: | Two SH-2F LAMPS I |

Notes: There are 27 ships in the US Navy’s “Ticonderoga” class, the first of which was launched in 1981. USS Yorktown and Vincennes of the class saw action in the strike against Libya in 1986, the latter also in various pre-war Gulf incidents a few years later. Ships of the class are fitted with ESM and ECM equipment.

HARRIER JUMP JET

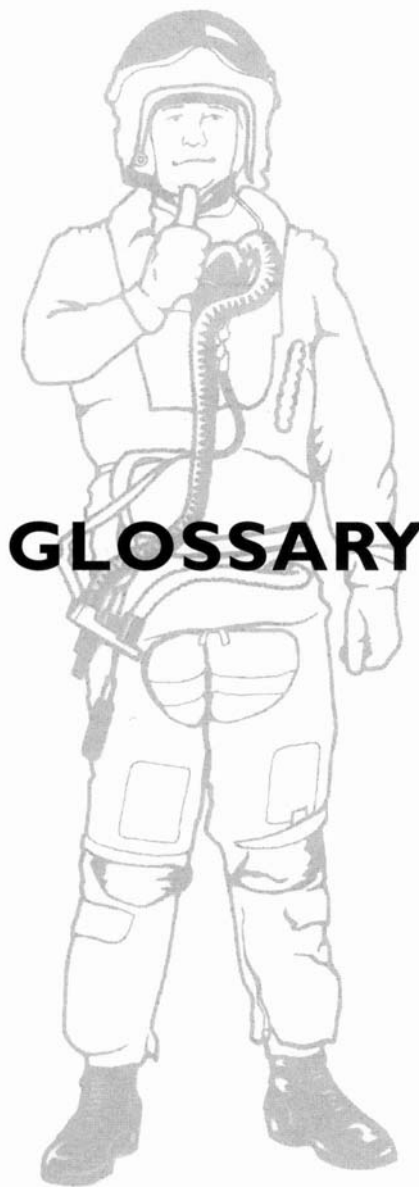


“Sheffield” Class (Type 42) Destroyer (UK)

Data for Batch 3 (Stretched) Type 42

| | |
|----------------------|------------------------------------------------------|
| Displacement: | 4,775 tons |
| Length: | 132m |
| Propulsion: | Two Rolls-Royce Olympus gas turbines giving 43,000hp |
| Speed: | More than 30kts |
| Range: | 4,000 miles @ 18kts |
| Complement: | 301 |
| Missiles: | Sea Dart SAMs (22) |
| Guns: | One 4.5in, four 20mm, two 20mm Mk7a, two 30mm Mk15 |
| Torpedoes: | Six Mk3 (two triple tubes) |
| Helicopter: | One Lynx HAS Mk3 |

Notes: The four stretched (Batch 3) versions of the earlier ships in this Royal Navy class are designed to provide area defence of a naval task force. All twelve vessels in this class are equipped with ECM, ESM, Air Search, Surface Search radar and Sonar.



GLOSSARY

HARRIER JUMP JET

GLOSSARY

| | | | |
|-----------------|----------------------------------------------------------|-----------------|--------------------------------------------------------------------------------------------------------------------------------------------------------------------------------------------------------------------------------------------------------------------------------------------------|
| A-A | Air-to-Air ^ | Blackout | Losing consciousness due to pulling too many positive g's. |
| AAM | Air-to-Air Missiles | Bounced | To be surprised in an air combat attack. |
| ABCCC | Airborne Battlefield Command, Control and Communications | BVR | Beyond Visual Range |
| ACC | Air Combat Command | BUFF | Big Ugly Fat F****r. Pilot terminology for large bomber. |
| AoA | Angle of Attack | CAP | Combat Air Patrol |
| AFCS | Automatic Flight Control System | CAS | Close Air Support |
| AFB | Air Force Base | CBU | Cluster Bomb Unit |
| AFV | Armoured Fighting Vehicle | CCIP | Continuously Computed Impact Point |
| AGM | Air-to-Ground Missile | Chaff | Cartridges of tiny foil strips dropped to confuse radar guided missiles. |
| AIM | Air Intercept Missile | COIN | Counter Insurgency |
| AIR | Air Inflatable Retard | CRT | Cathode Ray Tube |
| API | Armour Piercing Incendiary | DECS | Digital Engine Control System Monitors the performance of the powerplant at all times, automatically adjusting the thrust settings whilst taking into account the aircraft's speed and altitude within the performance limitations imposed by engine rpm, jet pipe temperature and acceleration. |
| APU | Auxiliary Power Unit | DEMU | Digital Electronic Map Unit |
| ARBS | Angle Rate Bombing Set | | |
| ASI | Airspeed Indicator | | |
| ATF | Advanced Tactical Fighter | | |
| Avionics | A Harrier's electronic systems | | |
| AWACS | Airborne Warning And Control System | | |
| Bank | To roll left or right in the air | | |
| BARCAP | Barrier Combat Air Patrol | | |

| | | | |
|-------------------------|----------------------------------------------------------------------------|-----------------------|------------------------------------------------------------------------------------------------------------|
| Diamond X | A HUD indicator in missile mode | FRS | Fighter, Reconnaissance and Strike (FRS.I) |
| DLIR | Downward Looking Infra Red | G | The force of gravity |
| Doppler Radar | Radar that sends out a continuous beam | GAU | Aircraft Gun Unit |
| Drag Factor | A measure of air resistance caused by loading external weapons stores | GBU | Guided Bomb Unit |
| ECCM | Electronic Counter Counter Measures | G suit | Worn by pilots to ease the effects of high g forces |
| ECM | Electronic Counter Measures | GR | Ground Reconnaissance (GR 7) |
| EFCS | Electronic Flight Control System | GP | General Purpose (GP Bombs) |
| EMP | Electro-Magnetic Pulse | HADES | Hunting Area Denial System |
| Energy Advantage | Term used by combat pilots for being faster and/or higher than an opponent | HAS | Hardened Air Shelters |
| EWS | Electronic Warfare System (Zeus) | HARM | High-Speed Anti-Radiation Missile |
| FAA | Fleet Air Arm (Royal Navy) | HARS | Heading And Attitude Reference System |
| FAC | Forward Air Control | Heat Signature | The heat emanating from a particular aircraft that can be detected and locked on to by infra red missiles. |
| Fire-and-Forget | A self-guided missile | HMMWV | High Mobility Multi-Purpose Wheeled Vehicle |
| Flares | Cartridges packed with magnesium that can fool heat-seeking missiles. | HOTAS | Hands On Throttle And Stick (The Harrier Joystick) |
| FLIR | Forward Looking Infra Red | HVACAP | High Value Asset Combat Air Patrol |
| FOL | Forward Operating Locations | HSD | Horizontal Situation Display |
| | | HUD | Head-Up Display |

HARRIER JUMP JET

| | | | |
|----------------|-----------------------------------------------------------------------------------|----------------|-----------------------------------------------------------------------------------------------------------------------------------------------------------------------------------|
| IFF | A device for Identification Friend or Foe | MEXE | Mechanical Engineers Experimental Establishment |
| IIR | Imaging Infra Red | | A 70 foot square pad made of linked aluminium planks is used to provide a firm landing ground and alleviate the problem of debris being ingested by the Harrier's Pegasus engine. |
| INS | Inertial Navigation System | | |
| IR | Infra Red Jamming Confusing enemy radar with noise made on a radio frequency | | |
| JPT | Jet Pipe Temperature | MMD | Moving Map Display |
| Knot | A nautical mile (6,076 feet) | MIRLS | Miniature Infra Red Line Scan |
| LANTIRN | Low-Altitude Navigation and Targeting, Infra Red for Night | MIA | Missing in Action |
| LAU | Launcher Unit | MiG | Mikoyan/Gurevich a type of Russian fighter |
| LERX | Leading Edge Root Extension (on Harrier wing) | MPD | Multi-Purpose Display |
| LGB | Laser-guided Bomb | MPCD | Multi-Purpose Colour Display |
| LIDS | Lift Improvement Device | NITE-OP | Night Imaging Through Electro Optics Package |
| LO | Low Observables | NVG | Night Vision Goggles |
| LOROP | Long-Range Oblique Photography | NWDS | Navigation And Weapon Delivery System |
| Lock-on | Radar acquire a target prior to firing weapon | OBOGS | On-Board Oxygen Generating System |
| LPI | Low Probability of Intercept | OCU | Operational Conversion Unit (Training) |
| Mach | A measure of speed based on the speed of sound at sea level (759 feet per second) | OTH | Over The Horizon |
| MAW | Missile Approach Warning System | Paint | To highlight using search radar. |
| MDC | Miniature Detonating Cord in canopy to break it free before pilot ejects. | PAVE | Precision Avionics Vectoring Equipment |
| | | PEC | Personal Equipment Connector |

| | | | |
|---------------------|-----------------------------------------------------|-----------------------|--------------------------------------------------------------------------------------------------------|
| PFCU | Powered Flight Control Unit | Target Bearing | The angle made by the target from the front of the Harrier: 00° is ahead, 270° is over your left wing. |
| POW | Prisoner of War | TBO | Time Between Overhauls |
| RADAR | Radio Detection And Ranging | Thrust | RPM |
| RCS | Reaction Control System | TRU | Transformer Rectifier Unit |
| Roll | Rotate the Harrier around its longitudinal axis. | UFC | Up Front Controls |
| RPM | Revs Per Minute (Thrust) | VIFF | Vectoring in Forward Flight |
| Rudder | Vertical control surface used to turn without Bank | VTO | Vertical Take-Off |
| RWR | Radar Warning Receiver | VVI | Vertical Velocity Indicator |
| SAAHS | Stability Augmentation and Attitude Hold System | WAC | Weapons Aiming Computer |
| SAG | Semi-Active Guidance | Waypoint | Target locations calculated by navigational computer. |
| SAM | Surface-to-Air Missile | Yaw | Moving the aircraft around its vertical axis |
| SAS | Stability Augmentation System | | |
| Shufti-Scope | A pilots' term for the Moving Map Display | | |
| Sortie | A single mission outing | | |
| SRAM | Short Range Attack Missile | | |
| Stall Speed | The minimum speed at which the aircraft will stall. | | |
| STO | Short Take-Off | | |
| STOV/L | Short Take-Off/ Vertical Landing | | |
| TACAN | Tactical Air Navigation | | |

AVIREX® U.S.A.



Avirex® flight jackets have a proud heritage, born during the golden years of WW2, when quality was #1 and everyone pulled together to lead America to victory.

During the War years when quality and durability were a matter of survival, we made leather and sheepskin flight jackets to keep our pilots warm and safe from the hostile skies.

WW2 leather flight jackets had a rare combination of image and mission, like the tough independent pilots who wore them. These fearless souls took risks, cheated death, and pushed back the frontiers of adventure and technology. They possessed a pioneering spirit that set them apart from the crowd, and their leather flight jackets identified them as members of an elite group of individuals.

Their jackets were treasured and traded, stolen and envied. They kept them warm and comfortable in the cockpit, and they looked great on the ground. They could scratch and scrape them, roll them up under their heads for some sack time, and if they didn't lose it in a card game, it would last a good twenty years.

Following our nation's success, we turned our efforts to the peaceful pursuit of manufacturing, and today we make the finest possible garments providing the ultimate in protection, comfort and utility. We have pledged ourselves to providing quality, durability, design and comfort in each and every product we offer.

When you purchase a genuine Avirex® product, you can be assured that our designers and craftsmen have made this product with your active lifestyle in mind, and men and women around the globe continue to demand the quality only Avirex® can provide.

At Avirex®, we have incorporated an exceptional combination of the old and new; good old fashioned quality and know-how, coupled with the newest, most sophisticated manufacturing techniques to offer uncompromising quality for today's modern world.

This is the Avirex ® assurance of Quality, Value, and Tradition.

We've made our Avirex ® products with a commitment to quality that has been an integral part of our longevity and success.

Our products are the finest available and our classic design and construction details are only updated when we believe the change will result in a superior product.

During the past several years, many customers have asked us what makes our jackets so different from those they see advertised elsewhere. The answer is quite simple:

1) Flight jackets are our primary business, they're not a sideline for us.

2) The quality of our jackets is so good that we were even asked by the U.S. Air Force to help update their specs when they reissued their leather type A-2 flight jackets a few years back. Avirex was awarded the first official contract for the Type A-2 leather jacket since they were discontinued in 1943 due to a most unpopular decision by the General of the U.S. Army Air Forces. This jacket is listed as "Current Standard" for issue to combat ready Allied pilots and air crews.

Avirex has also worked with the U.S. Navy to develop a new set of quality specifications for their Type G-1 Goatskin Flight Jacket. Currently, their Military Specification refers to the Avirex Type G-1 as the Navy's "benchmark of quality" that all other supplier must meet in order to be in consideration for Government manufacture of this jacket!

When you wear an Avirex ® garment, you can be assured that our merchandise and service carry an unconditional guarantee in materials and workmanship for your total satisfaction.

With years of obligation to the highest standards, we have earned the loyalty and trust of those who demand the very best!



MICRO PROSETM
SIMULATION • SOFTWARE

MicroProse Ltd., Unit 1 Hampton Road Industrial Estate, Tetbury,
Gloucestershire GL8 8LD. U.K. Tel: 0666 504326

MADE IN THE UK.

HARRIER

Jump Jet

TECHNICAL SUPPLEMENT

For IBM PC Compatibles

Contents

Your *Harrier Jump Jet* package should contain a manual, this technical supplement, a set of 5.25" high density disks or 3.5" high density disks, and a registration card.

Required Equipment

Computer: The simulation requires an IBM PC, AT, PS/2, or a computer 100% compatible with one of those models. The computer must have a high-density floppy-disk drive and a hard disk. The simulation will run on a 80286 microprocessor but an 80386 or better is recommended, with at least 1 Mb. of RAM. Please see the Memory Management section below for more information.

Controls: The simulation can be controlled entirely from a standard or portable PC keyboard or from a combination of joystick or mouse.

Display: The simulation requires a VGA/MCGA graphics system. If you are using a compatible graphics card/monitor, it must be 100% hardware compatible to one of the above.

Disk Drives: *Harrier Jump Jet* must be installed onto a hard disk.

DOS: You must have Microsoft MS-DOS version 5.0 or a 100% compatible DOS version.

Memory Management

You will also need about **600,000** bytes of **Base Memory** available to run the program. If the game fails to run properly your machine's memory is probably not configured correctly.

The easiest way to configure your machine temporarily is to make a Boot Disk.

Making a Boot Disk

At the C> prompt, place a disk into your floppy drive.

Type "**FORMAT A:/S**" and press [Return]. Follow the on-screen prompts.

When this has finished, you must use the DOS "EDIT" utility to create a number of files to put on your Boot Disk.

Type "**Edit**" press [Return].

When you are in the DOS Edit Screen type the following carefully, pressing [Return] after each line:

```
FILES=10  
DEVICE=C:\DOS\HIMEM.SYS  
DOS=HIGH,UMB  
BUFFERS=20
```

Now, **Save** this file as **A:CONFIG.SYS** using the File Menu.

Select New from your file menu options. When you are in the DOS Edit Screen type the following carefully pressing [Return] after each line:

```
PROMPT=$p$g  
PATH=C:\DOS
```

Save this file as **A:AUTOEXEC.BAT**

Your Boot Disk should contain 3 files: **CONFIG.SYS**, **AUTOEXEC.BAT** and **COMMAND.COM**

Using the Boot Disk

When you want to Boot Up the simulation, insert the Boot Disk into your floppy disk drive and reset the computer.

At the A> prompt, type C: and then follow standard **Loading Instructions** (see later).

Copy Protection

Harrier Jump Jet has no disk copy protection. This means that you can install the simulation files from the original disks to a hard disk. However, the program asks you a simulation-related question. Use the manual to answer the question. MicroProse regrets that continuing casual and organized software piracy requires that we retain this minimal form of copy protection.

Installation

An installation program is included on *Harrier Jump Jet* "Disk A". Insert "Disk A" into your floppy drive (Drive A or B) and designate that drive (by typing "A: [Return]" or "B: [Return]").

When the new prompt appears, type: "INSTALL [Return]"

Please follow any on-screen text instructions.

Loading Instructions

Boot your machine (if necessary) and wait until the "C>" prompt appears.

Type "CD\MPS\Harrier [Return]" and then type "Harrier [Return]" to run the simulation. It will begin to load.

Sound

If you have installed the program to another directory you must type "CD [Name of your directory]" first.

The simulation supports the following sound cards:

IBM Sound

This option supports the internal speaker standard on most IBM and compatible computers.

AdLib/Soundblaster Sound

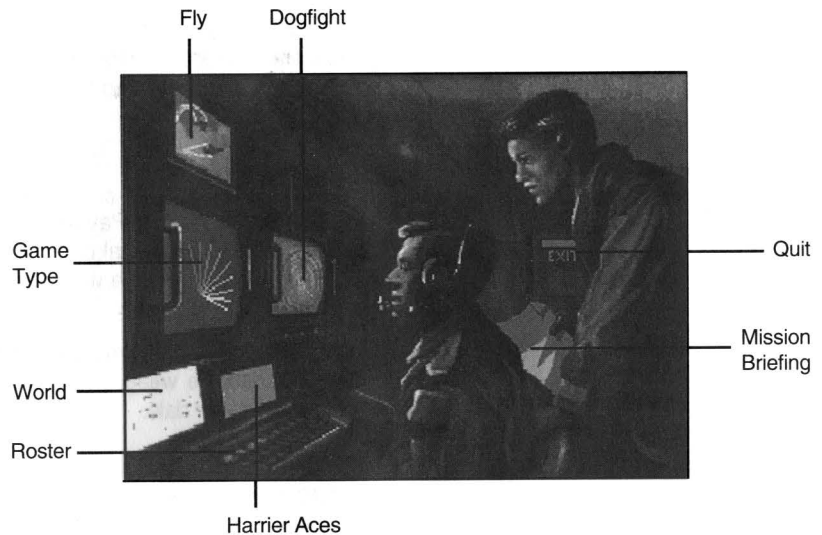
Use this option if you have an AdLib/Soundblaster or 100% compatible sound board installed in your computer.

Roland Sound

Use this option if you have a Roland Sound board installed in your computer.

Simulation Enhancements & Additional Information

Dogfighting



By selecting **Dogfight**, you will be placed inside the Harrier cockpit. You will be in the air already and will be liable to immediate attack by enemy aircraft.

Dogfight concentrates on instant in-the-air action. You will have limitless air-to-air weapons (Sidewinders and Cannons) available to you.

You can fly as any chosen pilot, in any Harrier, in any Air Force and in any Game world. Select these options in the Ready Room.

Additional Out-of-Plane Views

You will be able to perform Viffing manoeuvres (rotate jet nozzles) in dogfights. Points will be gained depending on the number of enemy aircraft shot down and these will be shown on the Harrier Aces Screen in the Ready Room.

Dogfight will end, either when you land, eject or when you get shot down.

The following additional Views are available in *Harrier Jump Jet*.

Slot View **F9**

Positioned directly behind the Harrier. The viewpoint remains level with the ground, to show the degree of pitch and roll as you manoeuvre your aircraft.

Chase View **Shift/F9**

Your view is that of a chase aircraft, following a short distance behind the Harrier. As the Harrier accelerates it will appear to run away from you and when it slows down it will appear to fall back towards you.

Weapon View **F10**

You are positioned directly behind the Harrier's active weapon. If ordnance is in flight you are positioned behind the most recently launched weapon. If no ordnance is in flight, you are positioned behind the Harrier and will follow the first weapon launched.

The Arming Screen

Saved Payload

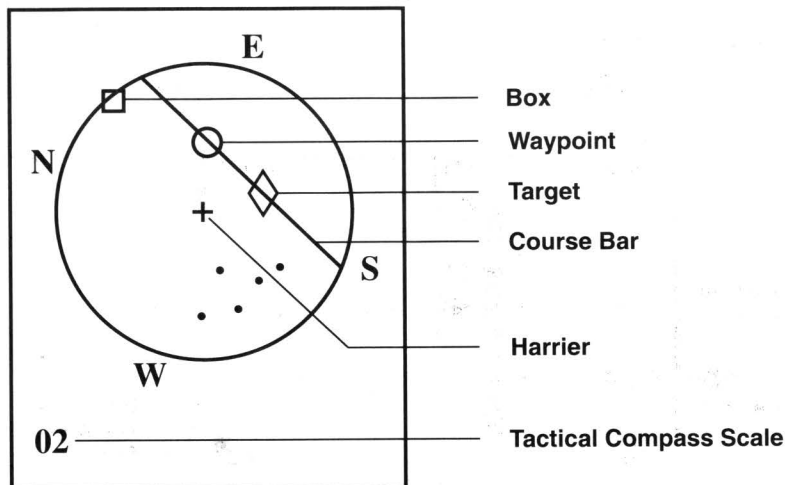
In addition to the Accept Payload/Change Payload options discussed in the manual, there is an additional button to implement a Saved Payload. This allows the player to load a favourite weapons load without having to enter the complete Arming Screen.

To save a weapon load you must select the Save button in the Arming Screen after you have loaded the weapons on the Harrier. This load can then be restored immediately at a later date.

Moving Map Display

The MMD shows all flight paths and waypoints. These can be turned off by pressing Key 7. The green line shows the section you are currently flying.

Tactical Compass Display



The Tactical Compass points will rotate and you will always travel towards the top of the screen.

The line across the Tactical Compass is the Course Bar. This will always cross two waypoints.

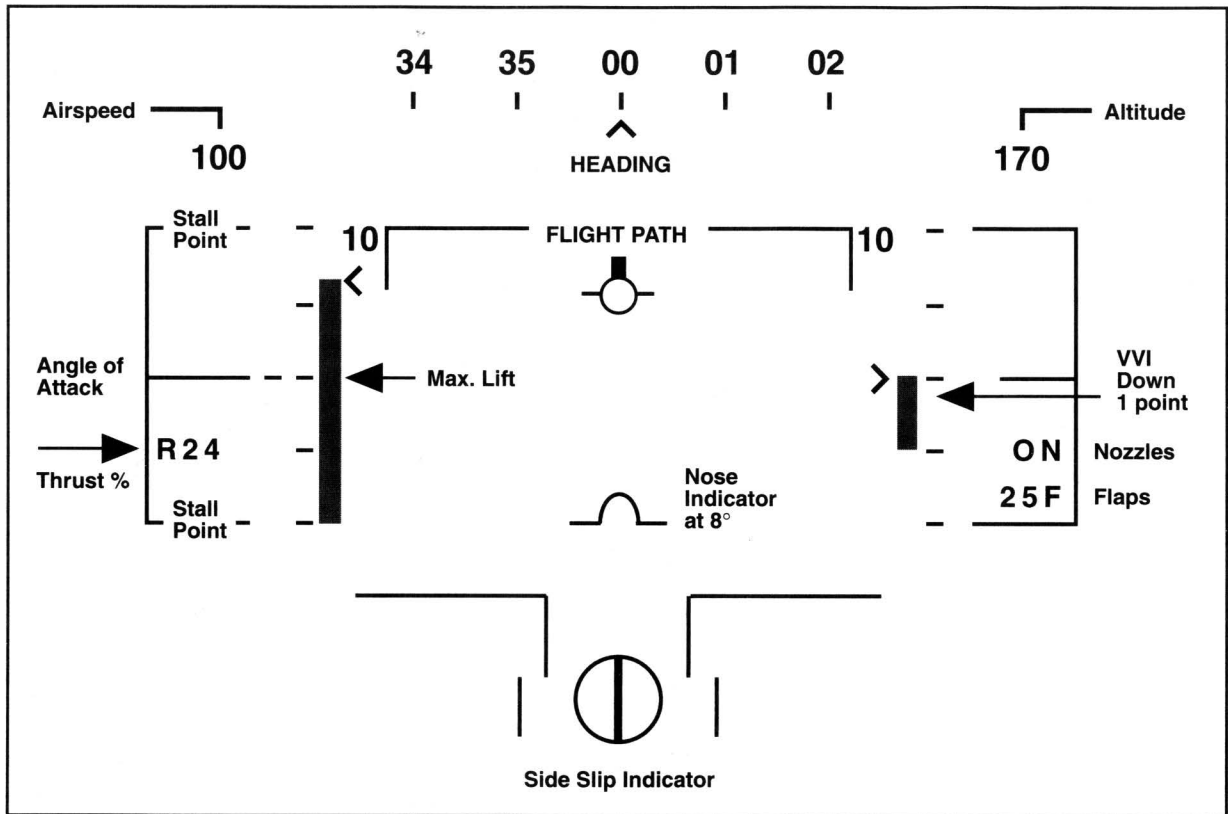
The square shows where you should be heading to pick up the current target.

Pressing the Backspace key in Easy Weapons Mode will acquire targets shown in the Tactical Compass Display.

Realistic Landings

You can land your Harrier in No Crash, Easy or Realistic Modes. Realistic landings are obviously the most difficult but the most satisfying to get right. The Harrier can land and take-off as a conventional fighter but for small sites and carriers short or vertical landings will have to be used.

Your landing site will be the final Waypoint. You can acquire it as you would any specific target by pressing Shift/Backspace.



Conventional Landings

All runways are situated North-South so that you can approach and land from either direction.

Set HUD Mode to VSTOL (TAB key).

Line up a heading of 00° or 180° when you are about 10 miles away.

Reduce throttle to 75% (Minus key).

Airbrakes on to reduce speed below 300 kts (Key B).

Gear down (Key G). You will slow down.

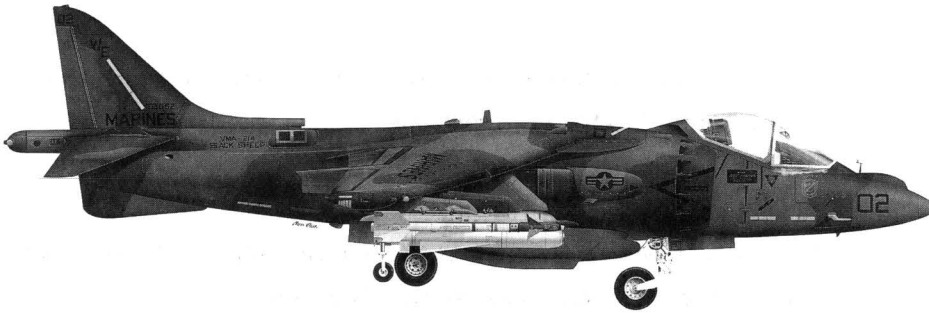
Release airbrakes (Key B).

You should be 1000 ft high flying at a speed of 150 kts.

The VVI (Vertical Velocity Indicator) should show 1 mark down from the mid-point.
Begin to lose height gently from 5 miles away.
At 2 miles away you should be 500 ft high.
At 1 mile away you should be 200 ft high.
Keep an eye on the Angle of Attack which should be marginally above the centre point.
Keep the nose up to increase speed as you reduce power.
Land at 100 kts with nose up 8°.
Fine adjust your position with the rudder keys (< or >).
When you have landed, cut power (Shift /Minus key -) allow some landing roll then apply Wheel brakes (Key B).

Short and Carrier Landings

All runways and carriers are situated North-South so that you can approach from either direction.
Set HUD Mode to VSTOL.
Line up a heading of 00° or 180° when you are about 10 miles away.
Reduce throttle to 75% (Minus - key).
Gear down 6 miles from runway (Key G).
3 miles from the landing site keep a speed of 120-130 kts.
Rotate nozzles to 40° ([key) and throttle up to 85% (Plus + key).
Watch the Angle of Attack scale and keep it above the mid point by pulling the nose up slightly.
Use the throttle (Plus + or Minus - keys) to control height, pitch the nose up to slow down and pitch the nose down to speed up.
Use the rudder (< or > keys) to line up on the landing site left/right.
Be careful to keep the Angle of Attack below the top of the scale (to avoid stalling).
Speed should be 100 kts at 1 mile at a height of 600 ft.
Reduce throttle gently (Minus - key), pull back on the stick without stalling and apply Airbrakes (Key B).
The Harrier should almost be hovering. The nozzles will control your height as you continue to reduce the throttle gently (Minus -key).
Try to get your mid-section wheels to touch down first, then the nose.
Cut power (Shift/Minus -).



IBM PC KEY G

COCKPIT VIEWS

Release 1,2,3,4, Appropriate Weapons in Salvo

Shift F7 Inverse Tactical Camera View

Shift Throt Minim Setting

Esc Menu Bar Game Pause On/Off

Esc

F1 Left Back

F2 Left Side

F3 Forward

F4 Right Side

F5 Right Back

F6 Up Head Back

F7 Tactical Camera View

F8 Free Flying Camera View

! 1

" 2

£ 3

\$ 4

% 5

6 Alter Tactical Compass Scale 1x - 16x

7 Moving Map MFD Waypoints On/Off

8 Tactical Compass Course Bar On/Off

9 Mission Briefing Reminder

0 At How Simp Flight On

Tab 3 HUD Mode Select

Shift/W Select Previous Waypoint

W Select Next Waypoint

E ECM On/Off Toggle

R

T

Shift/6 16x - 1x

Y

U

I

O

Caps Lock

A Autopilot On/Off

S ↑

D Auto Defence On/Off

F Flare Eject

G Gear Up/Dn

H HUD On/Off

J

K

L La HUD Messag

↑

Z Left MFD Up Cycle Through

X Right MFD Up Cycle Through

C Chaff Eject

V

Airbrake/Wheel-brakes On/Off

N NVG On/Off

M Attack/Scan Mode Select

< Left Rudder

Ctrl

Shift/Z Left MFD Down

Shift/X Right MFD Down

Alt

Fire/Release (Salvo of) Selected Weapon(s)

(Joystick Button2)

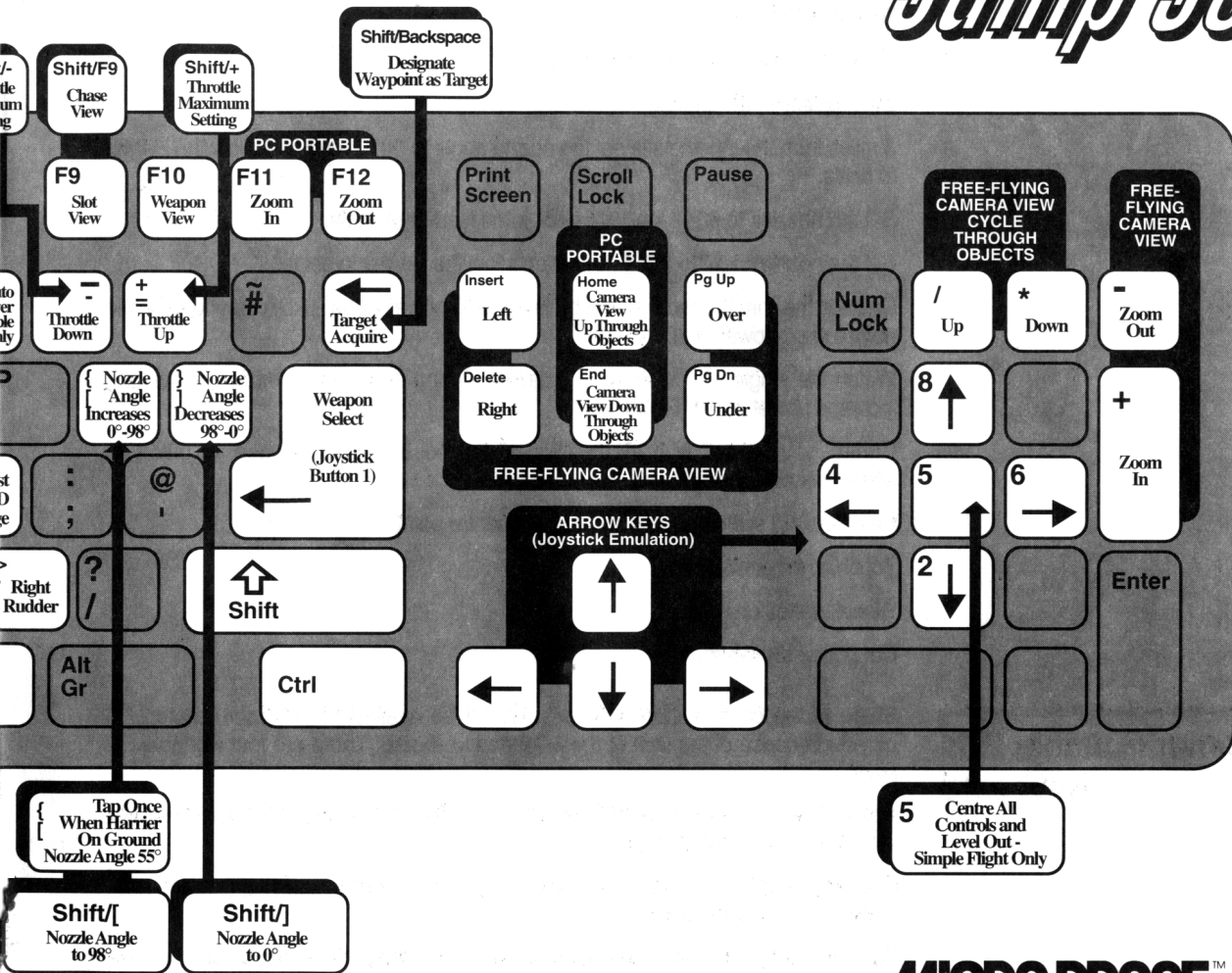
| | | | | | |
|-----------------------------|------------------------|----------------------------------------------------------|----------------------------------|---------------------------------------------|----------------------------------------|
| ALT / A Accelerate Time | ALT / E Eject | ALT / J Jettison 'Clean-up' All Air-to-Ground Weapons | ALT / F Dump Fuel | ALT / L Break Lock on Target | ALT / B Hide Game On/Off |
| ALT / H HUD Colour Cycle | ALT / Q Quit to DOS | ALT / S Sound On/Off | ALT / G Ground Shading On/Off | ALT / R Resupply Weapons (Training only) | ALT / T Convert to Training Mission |

Compatibles

KEYBOARD GUIDE

HARRIER

Jump Jet



MICROPROSETM
SIMULATION • SOFTWARE

Vertical Landings

This is a difficult manoeuvre so, initially, you are advised to practice vertical landings using Auto-Hover mode (Key 0) in Simple Flight Model.

All runways and landing sites are situated North-South so that you can approach from either direction. Remember to jettison any excess weapons (Alt/J) or fuel (Alt/F).

Set HUD Mode to VSTOL (TAB key).

Line up a heading of 00° or 180° when you are about 10 miles away.

Reduce height to 500 ft.

Reduce throttle to 80% (Minus - key).

Set nozzles to 40° ([key).

3 miles from the landing site set the nozzle angle to 50° ([key) and allow the Harrier to settle.

Set the nozzles to 60° ([key) then allow the Harrier to settle.

Set the nozzle angle to 70° ([key) then allow the Harrier to settle.

Balance the throttle and nozzles by increasing power (Plus + key) as you increase nozzle angle towards 80° ([key).

Watch the Angle of Attack scale to avoid stalling and, when nozzles are at 80°, increase power again (Plus + key).

Control your speed with the position of the nose. Keep the nose up until you achieve zero forward speed.

Keep the VVI scale just visible below the centre point.

Touch down gently.

Wheel brakes on (Key B).

Cut power (Shift/Minus -).

Harrier Portable PCs Keyboard

Some of the camera view functions will not be available to Portable/Laptop PC players because of the lack of the extended keyboard. There are four Portable PC keys:

Home Key (replaces Keypad Forward Slash / **Key**) Function: Free-flying camera view. Cycle 'up' through objects.

End Key (replaces Keypad Asterisk * **Key**) Function: Free-flying camera view. Cycle 'down' through objects.

Function Key F11 (replaces numeric Keypad .+ **Key**) Function: Zoom in/move 'free-flying' camera towards object.

Function Key F12 (replaces numeric Keypad - **Key**) Function: Zoom out/move 'free-flying' camera away from object.

The Read Me File

If there are any further enhancements to the simulation, these can be found in a Readme File. This file can be called up from the Install program. In addition, DOS 5.0 allows you to read this file in a text editor and to scroll the document up and down. Type "Edit Readme.Txt".

Operating Difficulties and Loading Problems

In the vast majority of cases a loading problem is not because of faulty software, but either incorrect loading procedure or hardware fault.

Please ensure that the loading instructions have been correctly executed. Alternatively, a virus may have transferred into your hardware from another piece of software. Pirated copies of games are an incredibly common source of viruses. It always pays to own original software.

In the unlikely event of a software fault please return the complete package, with your receipt, to the **place of purchase**. MicroProse regret that goods cannot be replaced unless bought from the company directly.

If you have any difficulty loading *Harrier Jump Jet* or need help while running the simulation, MicroProse will be happy to assist you on the Helpline. Please ring UK 0666 504399, Monday to Friday 0900 to 1700 hours. Have a pen and paper handy when you call.

Controller/Selector Summary

| Controller | Selector |
|----------------------|-----------------------------------------------------------|
| Mouse | Left or Right Mouse Button |
| Joystick (In-Flight) | Button 1 (Weapon select) Button 2 (Fire/Release salvo) |
| Keyboard Cursor Keys | Return |
| Keypad Cursor Keys | Return |

Key Guide

ENGINE POWER AND NOZZLE CONTROLS

| | |
|-------------------------|--------------------------------------------------------------------|
| Key Plus + | Throttle up |
| Shift/Plus + | Throttle to maximum setting |
| Minus Key - | Throttle down |
| Shift/Minus - | Throttle to minimum setting |
| Open Square Brackets [| Nozzle angle increases (towards 98°, slightly forward) |
| Close Square Brackets] | Nozzle angle decreases (towards 0°, straight back) |
| Shift / [| Nozzle angle to 98° |
| Shift /] | Nozzle angle to 0° |
| Key [(Tap) | Nozzle Key; one tap sets nozzles to 55°, when Harrier is on ground |

THE KEYBOARD FLIGHT CONTROLLER

| | |
|--------------|--------------------------------------------------------------|
| numeric 8 | Push forwards on stick |
| numeric 2 | Pull back on stick |
| numeric 5 | Centre all controls and level out (simple flight model only) |
| numeric 6 | Roll aircraft right |
| numeric 4 | Roll aircraft left |
| cursor up | Push forwards on stick |
| cursor down | Pull back on stick |
| cursor right | Roll aircraft right |
| cursor left | Roll aircraft left |

GENERAL FLIGHT CONTROLS

| | |
|--------------|------------------------------------------------|
| Key A | Autopilot on/off toggle |
| Key B | Airbrake/Wheelbrake on/off |
| Key G | Landing gear up/down toggle |
| Key W | Select (next) Waypoint |
| Shift / W | Select (previous) Waypoint |
| Alt/E | Eject |
| Alt/ J | Jettison all air-to-ground weapons/ 'clean up' |
| Alt/ F | Dump Fuel |
| Key 0 (Zero) | Auto-Hover (simple flight model only) |

| | |
|-------|--------------|
| Key < | Rudder left |
| Key > | Rudder right |

DISPLAYS

| | |
|---------------------|------------------------------------------------------------|
| TAB Key | HUD Mode select (cycle through VSTOL, NAV and A/G) |
| Key H | HUD on/off toggle |
| Key Z | Left MFD screen cycle up |
| Shift/Z | Cycle left MFD down |
| Key X | Right MFD screen cycle up |
| Shift/X | Cycle right MFD down |
| Keyboard 6 or Key S | Alter MFD tactical compass scale (1x-16x cycle through) |
| Shift 6 or Shift S | Opposite effect |
| Keyboard 7 | Moving map MFD waypoints on/off |
| Keyboard 8 | Toggles tactical compass course bar on/off |
| Keyboard 9 | Mission briefing reminder (on right MFD) |

WEAPON CONTROLS

| | |
|-----------------|---------------------------------------------------------------------------------------------|
| Backspace | Target Acquire |
| Shift/Backspace | Designates Waypoint as a target |
| Alt/L | Break lock |
| Key M | Attack/Scan mode select toggle/cycle (context sensitive to current weapon type selected) |
| Space Bar | FIRE/Release (salvo of) selected weapon(s) |
| Return | Weapon Type Select (cycle through weapons available) |
| Keyboard 1 | Set 1 (appropriate) selected weapon in salvo |
| Keyboard 2 | Set 2 (appropriate) selected weapons in salvo |
| Keyboard 3 | Set 4 (appropriate) selected weapons in salvo or release all weapons available. |
| Keyboard 4 | Set all (appropriate) selected weapons on aircraft in salvo |
| Key N | NVG/FLIR on/off |

DEFENCE CONTROLS

| | |
|-------|------------------------------------------------------------------------------------------------------------------------|
| Key D | Auto Defences on/off toggle |
| Key E | ECM on/off toggle (This applies to the RAF Zeus system, but only applies to the AV-8B when the AN/ALQ pod is carried.) |
| Key F | Flare Eject (Manual) |
| Key C | Chaff Eject (Manual) |

CAMERA AND VIEW CONTROLS

Cockpit Views

Function Keys

| | |
|----|------------------------------------------------|
| F1 | Left back (over the shoulder) in-cockpit view |
| F2 | Left side in-cockpit view |
| F3 | Forward in-cockpit view |
| F4 | Right side in-cockpit view |
| F5 | Right back (over the shoulder) in-cockpit view |
| F6 | Up (head back) in-cockpit view |

Tactical Views

| | |
|-----------|-------------------------------------------------------------------------------------------------------------------------------------------------------------------------------------------------------------------------------------------|
| F7 | Tactical Camera View You are positioned behind the Harrier looking past it at the target being tracked on the aircraft's HUD. This view rotates and pans to keep the Harrier and its target in view. |
| Shift/ F7 | Inverse Tactical Camera View You are positioned behind the Harrier's target looking past it at the Harrier. The target may be another plane or a ground target. This view rotates and pans to keep the Harrier and its target in view. |
| F8 | 'Free-flying' Camera View Select 'Free-flying Camera (see below) |
| F9 | Slot View |
| Shift/F9 | Chase View |
| F10 | Weapon View |

Free-Flying Camera Views

| | |
|---------------|--------------------------------------------------------------------|
| Numeric / | 'Free-flying' camera view: cycle 'up' through simulation objects |
| Numeric * | 'Free-flying' camera view: cycle 'down' through simulation objects |
| Numeric Pg Up | Rotate 'free-flying' camera up 'over' object |
| Numeric Pg Dn | Rotate 'free-flying' camera down 'under' object |
| Numeric Ins | Rotate 'free-flying' camera left round object |
| Numeric Del | Rotate 'free-flying' camera right round object |
| Numeric - | Zoom out (move 'free-flying' camera away from object) |
| Numeric + | Zoom in (move 'free-flying' camera towards object) |
| Key Pad Pg Up | Rotate 'free-flying' camera up 'over' object |
| Key Pad Pg Dn | Rotate 'free-flying' camera down 'under' object |
| Key Pad Ins | Rotate 'free-flying' camera left round object |
| Key Pad Del | Rotate 'free-flying' camera right round object |

Game Controls

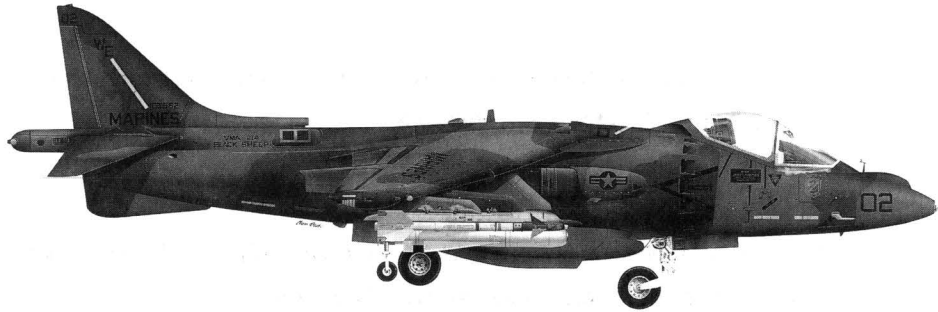
| | |
|------------|--------------------------------------------------------|
| Escape Key | Menu Bar and Game Pause on/off |
| Alt/A | Accelerated Time mode on/off |
| Alt/B | Boss mode (Hide game on/off) |
| Alt/G | Ground Shading on/off |
| Alt/H | HUD colour cycle |
| L | Last HUD message repeat |
| Alt/Q | Quit to DOS |
| Alt/S | Sound on/off |
| Alt/R | Re-supply Weapons and Fuel (Training Missions Only) |
| Alt/T | Convert to Training Mission |



Copyright ©1992 MicroProse Ltd.,
Unit 1, Hampton Rd Industrial Estate, Tetbury, Gloucestershire UK GL8 8LD.

This documentation and accompanying manual and floppy disks are copyrighted. The owner of this product is entitled to use this product for his or her personal use. Except for back-up copies of the disks for personal use and the quoting of brief passages for the purposes of reviews, no one may transfer, copy, back-up, give or sell any part of the manual or the information on the disks, or transmit in any form or by any means, electronic, mechanical, photocopying, recording or otherwise without the prior permission of the publisher. Any person or persons reproducing any part of this program, in any media, for any reason, shall be guilty of copyright violation and shall be subject to civil liability at the discretion of the copyright holder.

Made in the UK



IBM PC Compatibles KEYBOARD GUIDE

HARRIER *Jump Jet*

Release 1,2,3,4, Appropriate Weapons in Salvo

Shift F7 Inverse Tactical Camera View **Shift/Throttle Minimum Setting** **Shift/F9 Chase View** **Shift/+ Throttle Maximum Setting** **Shift/Backspace Designate Waypoint as Target**

COCKPIT VIEWS

PC PORTABLE

FREE-FLYING CAMERA VIEW

ARROW KEYS (Joystick Emulation)

5 Centre All Controls and Level Out - Simple Flight Only

Tap Once When Harrier On Ground Nozzle Angle 55°

Shift/[Nozzle Angle to 98° **Shift/] Nozzle Angle to 0°**

Esc Menu Bar Game Pause On/Off

F1 Left Back **F2 Left Side** **F3 Forward** **F4 Right Side** **F5 Right Back** **F6 Up Head Back** **F7 Tactical Camera View** **F8 Free Flying Camera View** **F9 Slot View** **F10 Weapon View** **F11 Zoom In** **F12 Zoom Out**

Print Screen **Scroll Lock** **Pause**

Insert Left **Home Camera View Up Through Objects** **Pg Up Over**

Delete Right **End Camera View Down Through Objects** **Pg Dn Under**

Num Lock **/ Up** *** Down** **- Zoom Out**

8 ↑ **+ Zoom In**

4 ← **5 ↑** **6 →**

2 ↓ **Enter**

↑ **↓** **←** **→**

Esc **F1** **F2** **F3** **F4** **F5** **F6** **F7** **F8** **F9** **F10** **F11** **F12**

! 1 **" 2** **£ 3** **\$ 4** **% 5** **Alter Tactical Compass Scale 1x - 16x** **Moving Map MFD Waypoints On/Off** **Tactical Compass Course Bar On/Off** **Mission Briefing Reminder** **Auto Hover Simple Flight Only** **Throttle Down** **Throttle Up** **#** **← Target Acquire**

Tab 3 HUD Mode Select **Shift/W Select Previous Waypoint** **W Select Next Waypoint** **E ECM On/Off Toggle** **R** **T** **Shift/6 16x - 1x** **Y** **U** **I** **O** **P** **{ Nozzle Angle Increases 0°-98°** **} Nozzle Angle Decreases 98°-0°** **Weapon Select (Joystick Button 1)**

Caps Lock **A Autopilot On/Off** **S ↑** **D Auto Defence On/Off** **F Flare Eject** **G Gear Up/Dn** **H HUD On/Off** **J** **K** **L Last HUD Message** **:** **@** **←**

↑ **;** **Z Left MFD Up Cycle Through** **X Right MFD Up Cycle Through** **C Chaff Eject** **V** **Airbrake/Wheel-brakes On/Off** **N NVG On/Off** **M Attack/Scan Mode Select** **< Left Rudder** **> Right Rudder** **?** **↑ Shift**

Ctrl **Shift/Z Left MFD Down** **Alt** **Shift/X Right MFD Down** **Fire/Release (Salvo of) Selected Weapon(s)** **(Joystick Button 2)** **Alt Gr** **Ctrl**

ALT/A Accelerate Time **ALT/E Eject** **ALT/J Jettison 'Clean-up' All Air-to-Ground Weapons** **ALT/F Dump Fuel** **ALT/L Break Lock on Target** **ALT/B Hide Game On/Off**

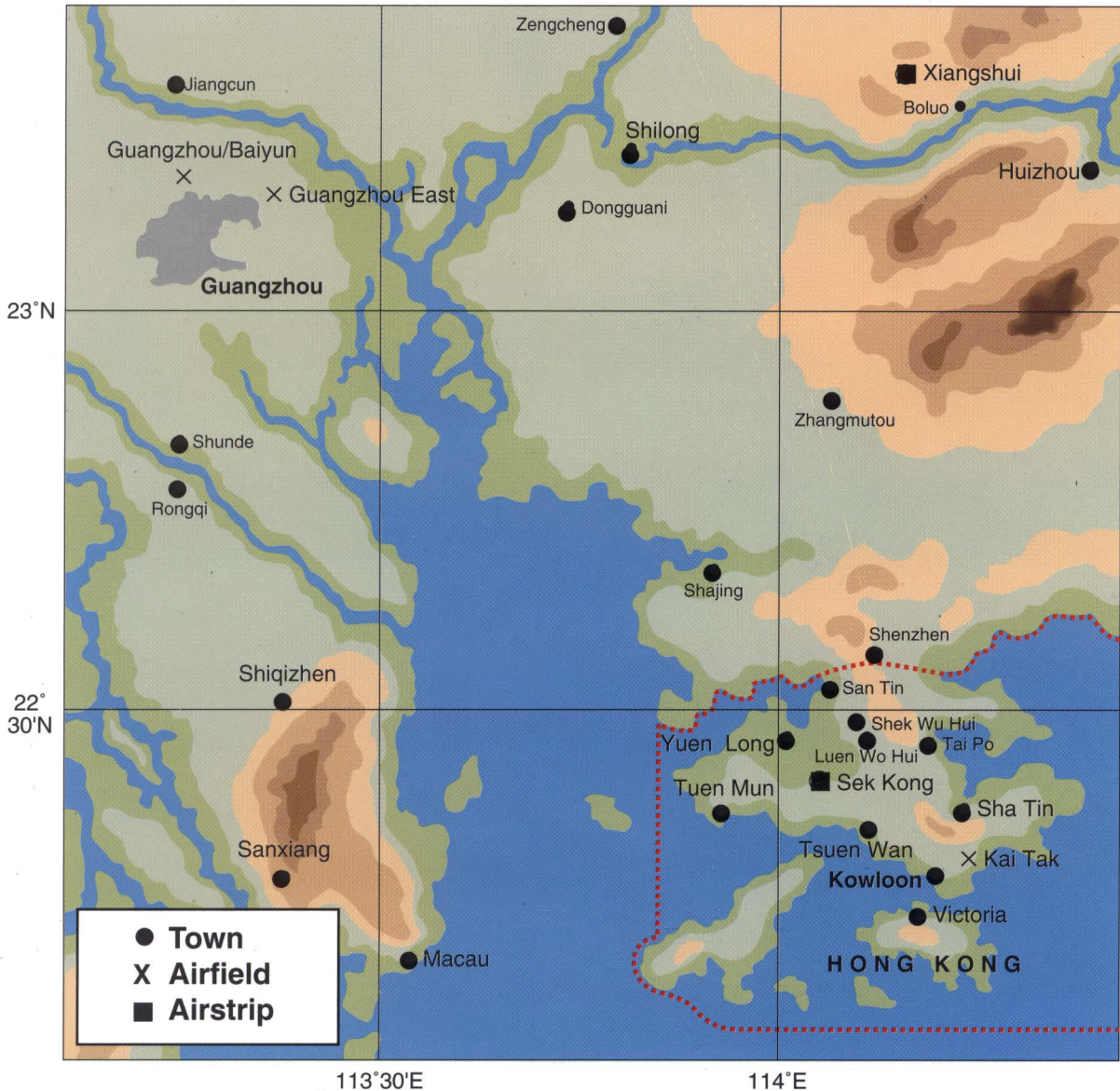
ALT/H HUD Colour Cycle **ALT/Q Quit to DOS** **ALT/S Sound On/Off** **ALT/G Ground Shading On/Off** **ALT/R Resupply Weapons (Training only)** **ALT/T Convert to Training Mission**



HARRIER

Jump Jet

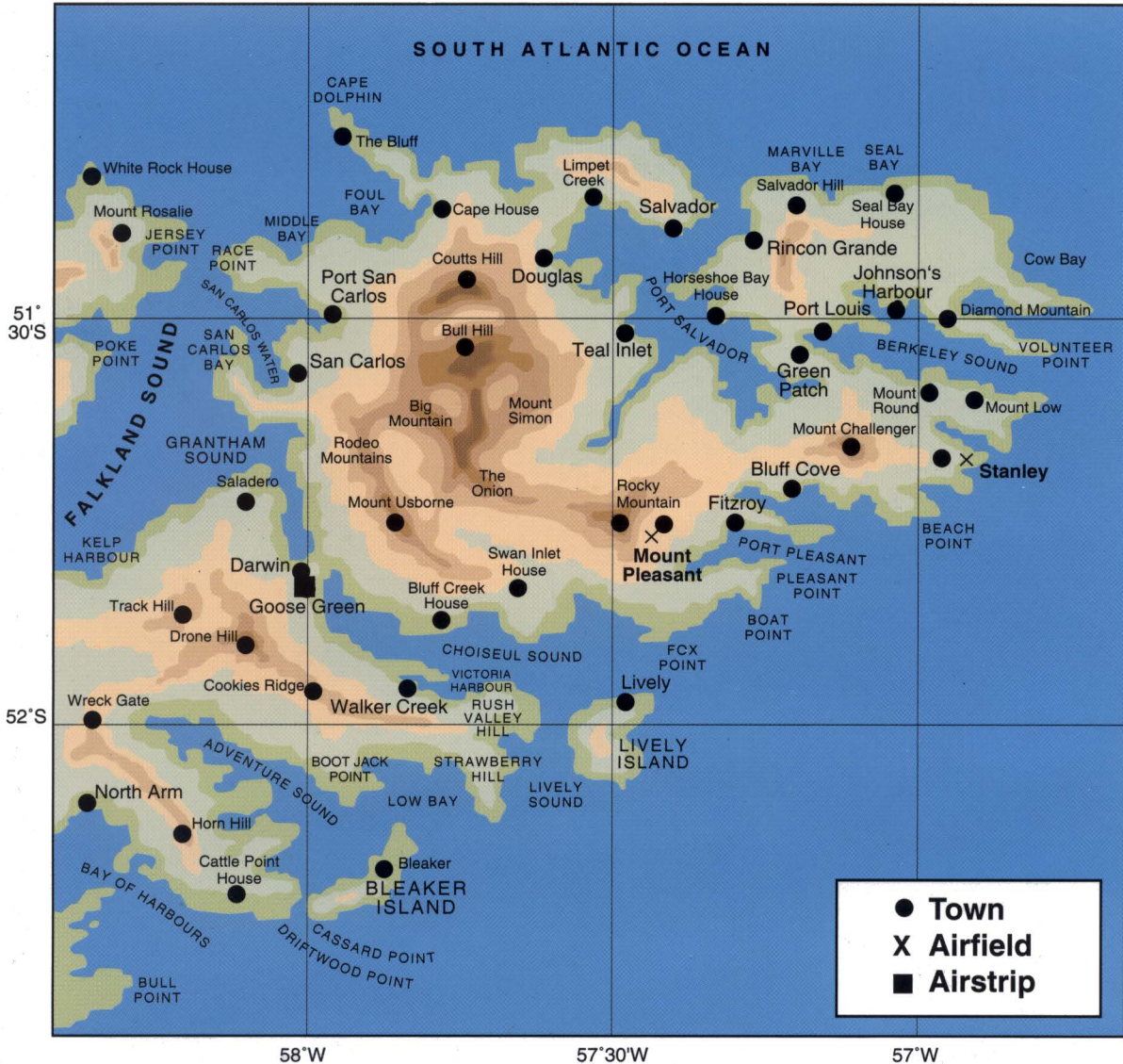
HONG KONG



HARRIER

Jump Jet

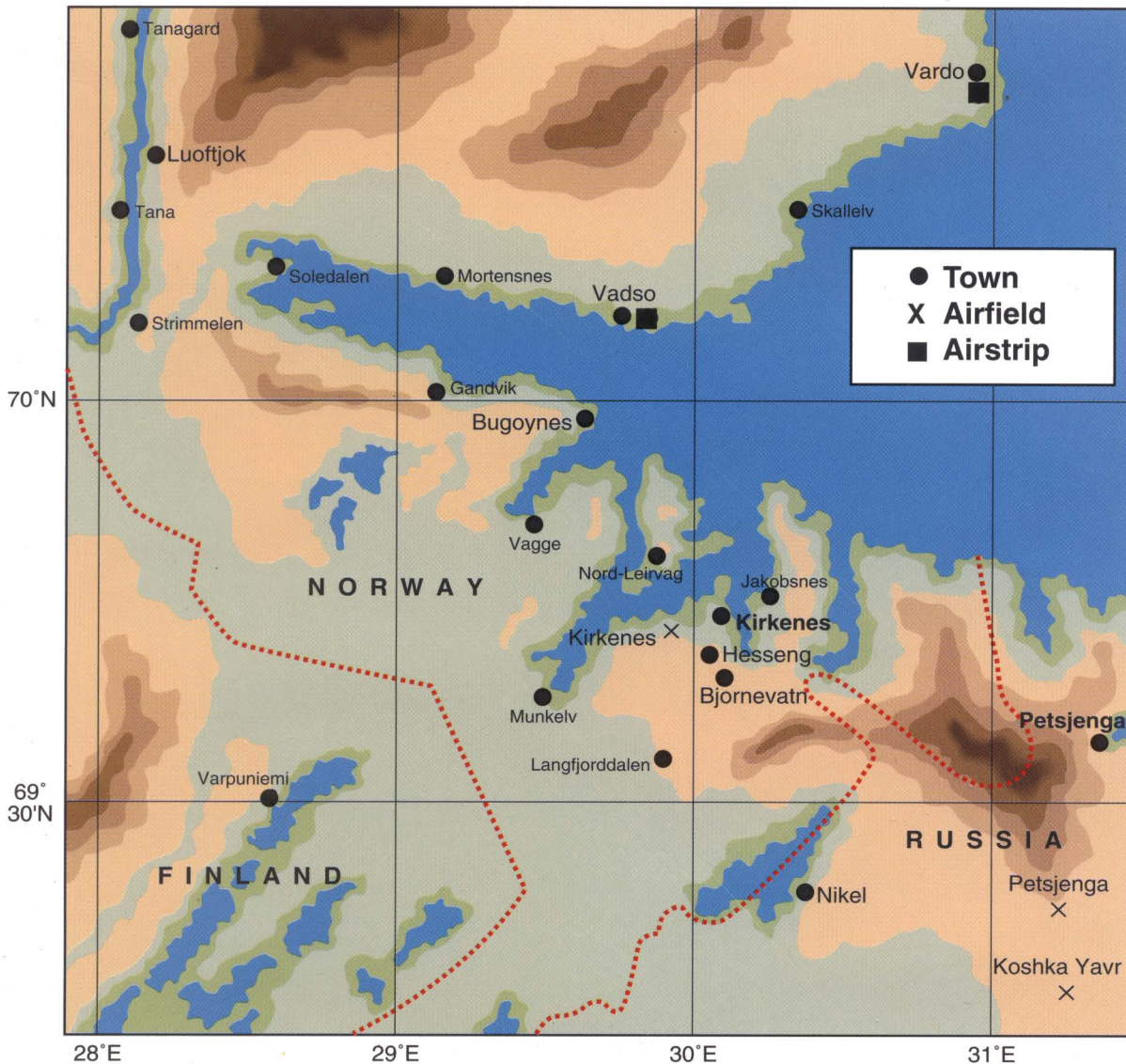
FALKLAND ISLANDS



HARRIER

Jump Jet

NORDKAPP



**Dept. GWC
MicroProse
FREEPOST
Swindon
SN2 6BR
U.K.**

**NO STAMP
NEEDED
IF POSTED
IN THE
U.K.**