

PA-2005



MAINBOARD MANUAL

DOC No. : 15319
Rev. : B2
Date : 1/1997
Part No. : NA

Handling Precautions

Warning :

1. Static electricity may cause damage to the integrated circuits on the mainboard.
Before handling any mainboard outside of its protective packaging, ensure that there is no static electric charge in your body.
2. There is a danger of explosion if the battery is incorrectly replaced.
Replace only with the same or an equivalent type recommended by the manufacturer.
3. Discard used batteries according to the manufacturer's instructions.

Observe the following basic precautions when handling the mainboard or other computer components:

- Wear a static wrist strap which fits around your wrist and is connected to a natural earth ground.
- Touch a grounded or anti-static surface or a metal fixture such as a water pipe.
- Avoid contacting the components on add-on cards, boards and modules and with the “gold finger” connectors plugged into the expansion slot. It is best to handle system components by their mounting bracket.

The above methods prevent static build-up and cause it to be discharged properly.

Trademark

All trademarks mentioned in this manual are registered properly of the respective owners.

Copyright

This manual may not, in whole or in part, be photocopied, reproduced, transcribed, translated, or transmitted in whatsoever form without the written the consent of the manufacturer, except for copies retained by the purchaser for personal archival purposes.

Chapter 1 Overview

Main Features 2
Package Checklist 4
 The PA-2005 Mainboard 5
 The Cables 6
 This User Manual 7
Something Interesting 8
 The BIOS Setup Utility 8
 IRQ Functionality 9
 DMA Channels of ISA Cards 10
 Enhanced IDE 10
 Serial Infrared (SIR) Connections 11
 Universal Serial Bus (USB) Functionality 12

Chapter 2 Installation Procedures

Mainboard Layout 14
1). Set System Jumpers 15
 Jumpers 15
 Clear Password: CPW 16
 Flash EPROM Type Selection: MFG5 16
 PS/2 Mouse Feature: MS_1 and MS_2 (optional) 17
 PCI2 ID: PCI2ID 17
2). Install RAM Modules 18
 DRAM Memory 18
 RAM Module Configuration 19
 Install SIMMs 20
 Remove SIMMs 21
 Cache Memory 22
 256KB Cache SRAM 22
 512KB Cache SRAM 23
 1MB Cache SRAM 24
3). Install the CPUs 25
 CPU External Clock (Bus) Frequency:
 CLK1, CLK2, CLK3 27

CPU to Bus Frequency Ratio: FREQ1, FREQ2.....	28
Intel Pentium CPUs	29
Frequency.....	29
Voltage.....	30
AMD-K5/K6 CPUs.....	31
Frequency.....	31
Voltage.....	32
Cyrix 6x86/MX CPUs	33
Frequency.....	33
Voltage.....	34
IBM 6x86/MX CPUs.....	35
Frequency.....	35
Voltage.....	36
Installation of Cyrix (or IBM) 6x86 CPU Fan.....	37
4). Install Expansion Cards	38
5). Connect Cables and Power Supply	40
Keyboard Connector: AT_KB	40
Serial Port Connectors: COM1 and COM2.....	40
CPU Fan Connectors: FAN	41
Floppy Diskette Drive Connector: FLOPPY	41
Front Panel Block Connector: F_PNL	42
IDE HDD Device Connectors:	
PRIMARY and SECONDARY	43
Infrared Connector: IR	43
Outlet Connector: OUTLET	44
PS/2 Mouse Connector: MS_CON	44
Power Connector: POWER	45
Printer Block Connector: PRINTER	45
Remote Power Connector: RPW_CON.....	46
Universal Serial Bus Connector: USB1 and USB2 (Reserved For Future Upgrade).....	46

Chapter 3 Award BIOS Setup

CMOS Setup Utility.....	47
Standard CMOS Setup	48
BIOS Features Setup.....	50

Chipset Features Setup.....	53
Power Management Setup.....	57
PCI Configuration Setup.....	60
PnP Configuration Setup.....	62
Load BIOS Defaults.....	63
Load Setup Defaults.....	63
Supervisor/User Password.....	63
IDE HDD Auto Detection.....	64
Save and Exit Setup.....	65
Exit without Saving.....	65

Appendix A Application Note

This Page Intentionally Left Blank

Overview

The PA-2005 mainboard combines the advanced capabilities of the VIA Apollo 580VP® chipset with a high-performance concurrent PCI local bus architecture to provide the ideal platform for unleashing the unsurpassed speed and power of the Intel Pentium® processor.

This highly-flexible mainboard is designed to run a full range of Intel Pentium™, Cyrix 6x86/MX™, IBM 6x86/MX™ and AMD-K5/K6™ processors; and can be easily upgraded using its 321-pin ZIF socket. The processor's advanced performance is complemented by a second level write back Pipeline Burst SRAM cache of up to 1MB and main memory of up to 512MB RAM. The main memory is installed using the board's four 72-pin SIMM sockets that accept an unrivaled choice of high-speed EDO, ultra-fast Burst EDO, or standard Fast Page Mode DRAM.

The PA-2005 integrates a full set of I/O features onboard, including two 16550 UART compatible serial ports, one EPP/ECP capable parallel port, and one Floppy Disk Drive controller. It also comes with a built-in Enhanced IDE controller that provides convenient, high-speed PCI Bus Master connections with up to four IDE devices, including Hard Disk and CD-ROM drives. Three 16-bit ISA slots and four 32-bit PCI slots provide ample room for further expansion. The mainboard also features support for the state-of-the-art Universal Serial Bus (USB) that provides ease-of-use and high-speed Plug & Play connections to future USB compliant peripheral devices. The IrDA compliant serial port and optional onboard SIR support further enhance system I/O connectivity.

This chapter gives you a brief overview of the PA-2005 mainboard. In addition to basic information on the board's main components and features, it also provides advice on how to upgrade and expand it. For updated BIOS, drivers, or product release information, please visit FIC's home page at: <http://www.fic.com.tw>.

Congratulations on your decision to adopt the PA-2005 mainboard. With its high-speed PCI local bus architecture and ultra-fast I/O connections, the PA-2005 provides the ultimate solution for optimizing the performance of your high-end system.

Main Features

The PA-2005 mainboard comes with the following high-performance features:

- **Easy Installation**
Award BIOS with support for Plug and Play, auto detection of Hard Drive and IDE features, and MS Windows 95®.

- **Flexible Processor Support**
The onboard 321-pin ZIF socket supports Intel Pentium (P54C) CPU speed 75/90/100/120/133/150/166/200 MHz processors / P54CTB / P55C.
Cyrix 6x86-P120+ (100 MHz) / 6x86-P133+ (110 MHz) / 6x86-P150+ (120 MHz) / 6x86-P166+ (133 MHz) / 6x86-P200+ (150 MHz)*
/ MX series processors.
IBM 6x86-P120+ (100 MHz) / 6x86-P133+ (110 MHz) / 6x86-P150+ (120 MHz) / 6x86-P166+ (133 MHz) / 6x86-P200+ (150 MHz)*
/ MX series processors.
AMD K5-PR75 (75 MHz) / K5-PR90 (90 MHz) / K5-PR100 (100 MHz) / K5-PR120 (90 MHz) / K5-PR133 (100 MHz) / K5-PR150 (105 MHz) / K5-PR166 (116 MHz) / K5-PR200 (133 MHz) / K6-166/200 processors.

NOTE : * The support for Cyrix 6x86-P200+ and IBM 6x86-P200+ is optional.

- **Leading Edge Chipset**
Intel Apollo 580VP chipset, including a CPU interface controller, advanced cache controller, integrated DRAM controller, synchronous ISA bus controller, PCI local bus interface, integrated power management unit.

- **Ultra-fast Level II Cache**
Supports up to 256KB/512KB/1MB synchronous PBSRAM direct-mapped write-back cache memory.

- **Versatile Main Memory Support**
Accepts up to 512MB RAM in two banks using 72-pin SIMMs of 4, 8, 16, 32, 64, 128MB with support for EDO, BEDO, and Fast Page Mode memory.

- **ISA & PCI Expansion Slots**
Three 16-bit ISA and four 32-bit PCI expansion slots provide all the room you need to install a full range of add-on cards.

- **USB Support (reserved for future upgrade)**
Onboard support for two Universal Serial Bus connectors via a plug-in connector.

- **Enhanced PCI Bus Master IDE Controller**
Integrated Enhanced PCI local bus IDE controller with two connectors supports up to four IDE devices such as Hard Disk, CD-ROM or Tape Backup drives via two channels for high speed data throughput. This controller supports PIO Modes 3 and 4, and DMA Mode 2 for optimized system performance.

- **Super Multi I/O**
Integrated Winbond W83877F or W83877AF I/O chipset features two 16550A UART compatible serial ports, one EPP/ECP capable parallel port, one IR port, and one floppy disk drive connector.

Package Checklist

Please check that your package contains all the items listed below. If you discover any item is damaged or missing, please contact your vendor.

- The PA-2005 mainboard
- One serial port and parallel port cable with bracket
- One serial port cable with bracket
- One IDE device cable
- One floppy disk drive cable
- One SIR cable (optional)
- This user manual
- PS/2 mouse cable with bracket (optional)

The PA-2005 Mainboard

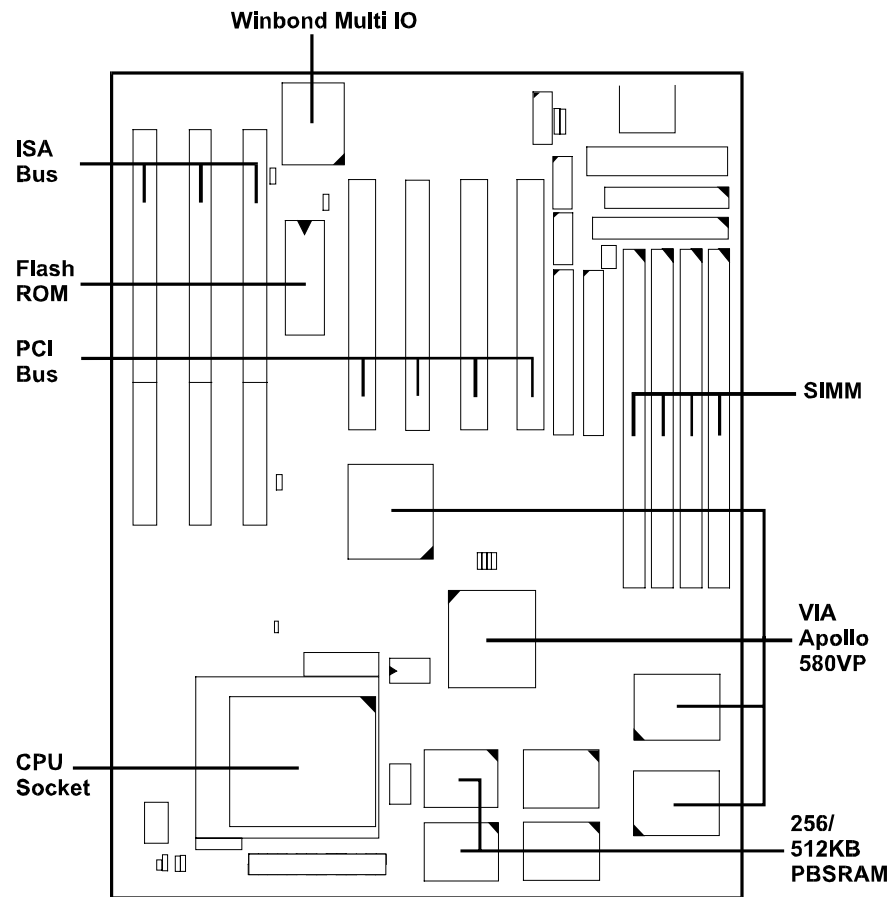

The Cables

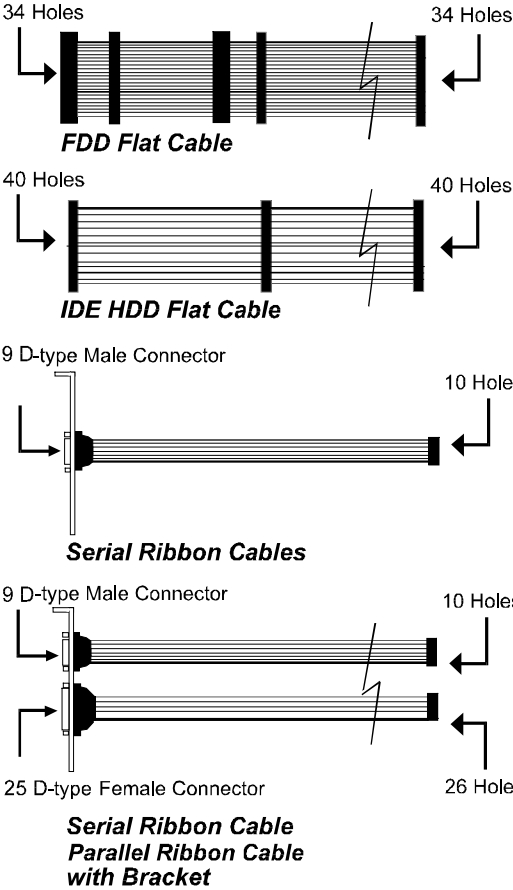

This User Manual

This manual is designed to guide you and facilitate your use of the PA-2005 mainboard. It contains a description of the design and features of the mainboard, and also includes useful information for changing the configuration of the board and the system it is installed in. The manual is divided into three chapters:

- Chapter 1 - Overview
gives an overview of the mainboard and describes its major components and features.
- Chapter 2 - Installation Procedures
gives instructions on how to set up the mainboard, including jumper settings and CPU installation guides.
- Chapter 3 - Award BIOS Setup
briefly explains the mainboard's BIOS system setup in general and tells you how to run it and change the system configuration settings.
- Appendix
provides application tips that help the mainboard to achieve its best performance.

NOTE : The material in this manual is for information only and is subject to change without notice. We reserve the right to make changes in the product design without reservation and without notification to its users. We shall not be liable for technical or editorial omissions made herein; nor for incidental or consequential damages resulting from the furnishing, performance, or use of this material.

Something Interesting

This section provides useful information that you will need to know should you decide to modify or upgrade the configuration of the mainboard and the system it is installed in. If you do not have the confidence to upgrade the mainboard yourself, we advise that you consult a qualified service technician for assistance.

The BIOS Setup Utility

The BIOS (Basic Input Output System) is the basic firmware that instructs the computer how to operate. For the BIOS to work properly, there must be a record of the computer's hardware and configuration settings for it to refer to. This record is created using the Setup Utility, a program that is stored permanently in the BIOS ROM chip on the mainboard.

The system configuration record created by the Setup Utility is also stored on the mainboard, but not permanently. This section of the memory is stored in the NVRAM.

When you buy your computer, the system configuration record will already be set and may in some cases differ from the basic defaults. The first time you use your computer or when you need to re-configure your system, you should run the Setup Utility and write down the settings.

IRQ Functionality

As you read through this manual, you will see the term **IRQ** on a number of occasions. It is important for you to know what this term means, particularly if you intend to upgrade your system.

IRQ stands for **Interrupt Request**, the process in which an input or output device tells the processor to temporarily interrupt its current task and immediately process something from the source of the interrupt. When it has completed this, the processor returns to the task it was already processing. Devices that need an IRQ line to operate sometimes need to have exclusive use of that line.

A large number of add-on cards, such as sound cards and LAN cards, require the use of an IRQ line to function. Some of IRQs may already be in use by components in the system such as the keyboard and mouse. Add-on cards that need to use an IRQ draw from the unused group of IRQs. When installing a card that uses an IRQ, it will have a default IRQ setting which you might have to change if that IRQ is already in use and cannot be shared.

Both ISA and PCI add-on cards may need to use IRQs. System IRQs are available to add-on cards installed on the ISA bus first; the remaining ones can be used by cards installed on the PCI bus. There are two categories of ISA add-on cards: so-called **Legacy** ISA cards, which need to be configured manually and then installed in any available ISA slot; and **Plug and Play** (PnP) ISA cards, which are configured automatically by the system. As a result, when you install Legacy ISA cards, you have to carefully configure the system to ensure that the installed cards do not conflict with each other by having the same IRQ. With PnP cards, on the other hand, IRQs are assigned automatically from the ones available in the system. In the case of PCI add-on cards, the BIOS automatically assigns an IRQ card to the PCI slot the card is installed in.

DMA Channels of ISA Cards

Some Legacy and PnP ISA add-on cards may also need to use a Direct Memory Access (DMA) channel. DMA assignments for this mainboard are handled in the same way as the IRQ assignment process outlined above. For more information, please refer to Chapter 3 of this manual.

Enhanced IDE

This mainboard features an integrated Enhanced IDE controller that provides convenient, high-speed connections with up to four IDE devices, such as Hard Disk, CD-ROM and Tape Backup Drives. Enhanced IDE is an upgrade of the original IDE specification and provides increased capabilities and performance in a number of areas, including support for Hard Disk Drives utilizing the PIO Mode 4 timing scheme.

With the integrated IDE controller you can connect up to four IDE peripheral devices to your system. All devices are categorized in the same way that IDE Hard Disks were configured in the past, with one device set as the **Master** device and the other as the **Slave** device. We recommend that Hard Disk Drives use the **Primary IDE connector** and that CD-ROM drives utilize the **Secondary IDE connector** for improved system performance.

Serial Infrared (SIR) Connections

This mainboard features support for highly-sophisticated SIR technology, which allows bi-directional and cordless data transactions with other IrDA compliant computers and peripheral devices using infrared as a medium. This transmission is carried out in either Full Duplex Mode or Half Duplex Mode. The former allows simultaneous data transmission and reception, while the latter disables the reception when transmission occurs.

The I/O chipset on this mainboard features a SIR interface that is fully compliant with the IrDA standard. An IrDA device can be installed via a **9-pin D-type connector** in the rear panel of the computer which is linked by a cable to the onboard IrDA pinhead, as shown in the illustration below.

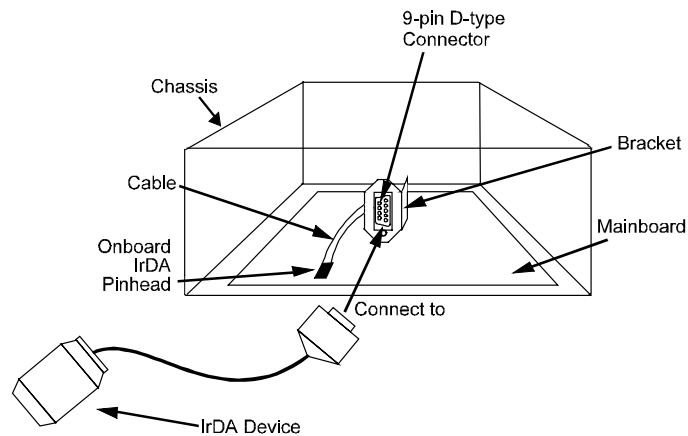

The **serial port COM2** on this mainboard is designed to be a **SIR compliant** port. If you wish to install the SIR connection feature, you need to adjust the BIOS option for high-speed performance.

Universal Serial Bus (USB) Functionality

This mainboard features integrated support for state-of-the-art USB technology, which provides high-speed and easy-to-use Plug & Play connections to the future generation of external peripherals, such as keyboards, mouse, monitors, game devices, scanners, printers, and fax/modems.

USB overcomes conventional I/O bottlenecks by combining the I/O ports into a single dual-channel connector. For optimum ease of use and flexibility, USB not only allows the automatic detection and configuration of peripherals after installation, but also enables the simultaneous connection.

This mainboard features an optional USB connector bracket that is connected by a cable to the onboard USB pinhead. The bracket can be installed in one of the I/O expansion slots on the rear panel of the system, as shown in the illustration below. It provides fast and convenient Plug and Play peripheral connections outside your computer, allowing you take full advantage of the universal functionality and flexibility of USB technology.

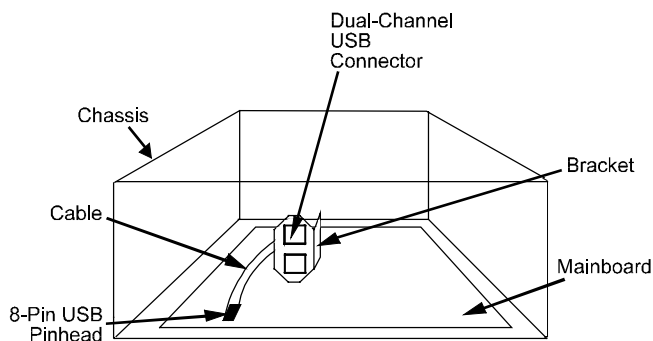

Installation Procedures

The PA-2005 has several user-adjustable jumpers on the board that allow you to configure your system to suit your requirements. This chapter contains information on the various jumper settings on your mainboard.

To set up your computer, you should follow these installation steps:

- Step 1 -
Set system jumpers
- Step 2 -
Install System RAM modules
- Step 3 -
Install the CPU
- Step 4 -
Install expansion cards
- Step 5 -
Connect cables and power supply
- Step 6 -
Set up BIOS feature (Please read Chapter Three.)

CAUTION : If you use an electric driver to install this mainboard on your chassis, please wear a static wrist strap and the recommended electric driver torque is from 5.0 to 8.0 kg/cm to avoid damaging chips' pins.

Mainboard Layout

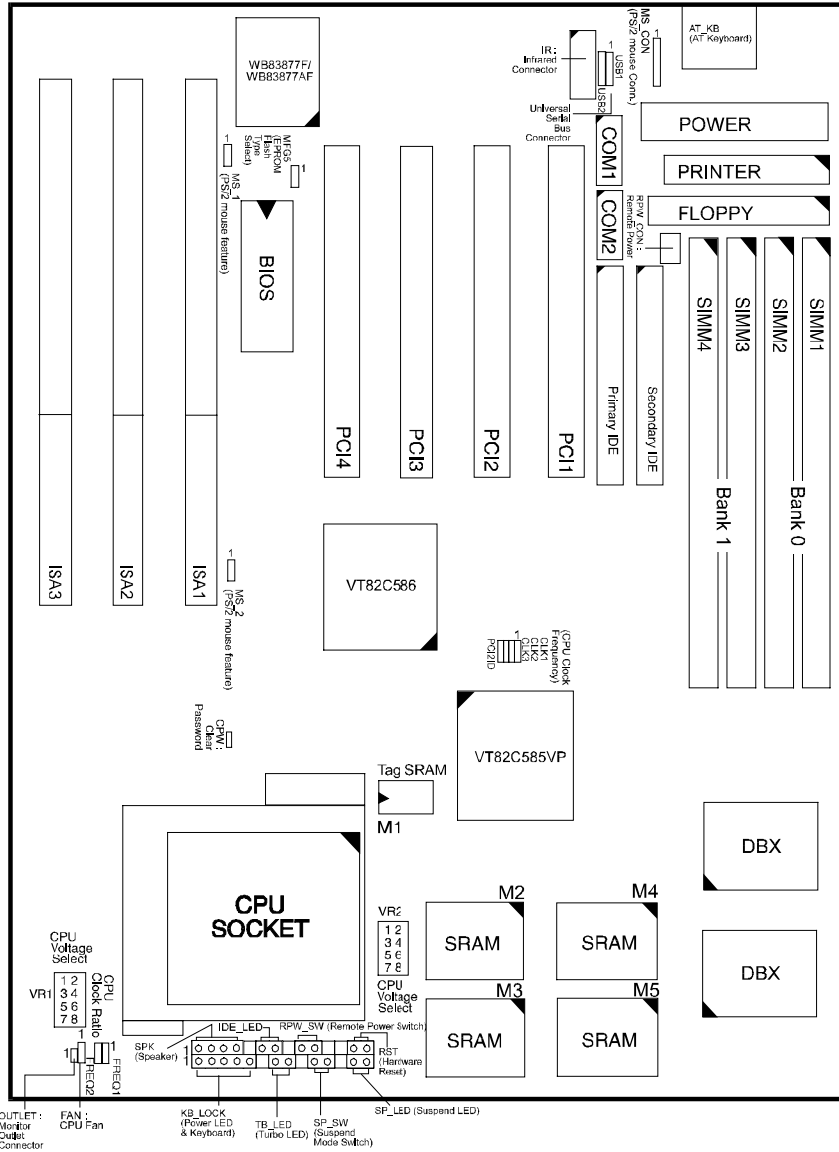

1). Set System Jumpers

Jumpers

Jumpers are used to select the operation modes for your system. Some jumpers on the board have three metal pins with each pin representing a different function. To **set** a jumper, a black cap containing metal contacts is placed over the jumper pins according to the required configuration. A jumper is said to be **shorted** when the black cap has been placed on one or two of its pins. The types of jumpers used in this manual are shown below:

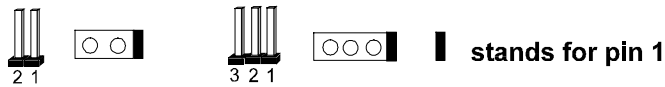
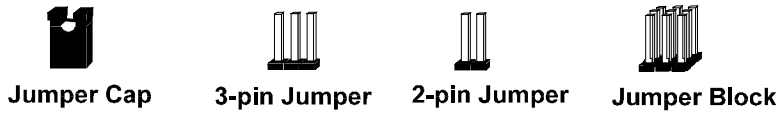

Jumpers are shown as above



Jumper cap is shown as above



Jumpers in a Block

NOTE : Users are not encouraged to change the jumper settings not listed in this manual. Changing the jumper settings improperly may adversely affect system performance.

Clear Password: CPW

This jumper allows you to set the password configuration to **Enabled** or **Disabled**. You may need to enable this jumper if you forget your password.

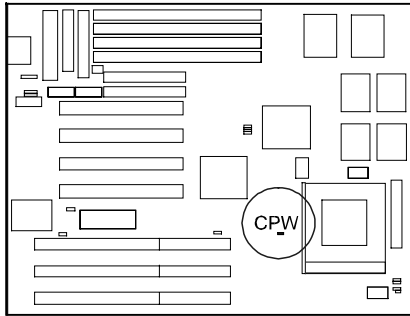

1

Enable



1

Disable
(Default)

Flash EPROM Type Selection: MFG5

This jumper allows you to configure the Flash EPROM chip. This mainboard uses the SST chip as default.

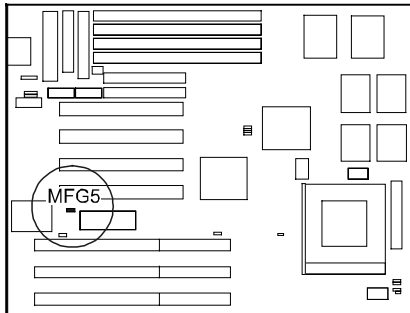

1

Intel 28F001BX-T



1

SST 29EE010

PS/2 Mouse Feature: MS_1 and MS_2 (optional)

If your mainboard does not have these two jumpers, MS_1 and MS_2, do not need to refer to this PS/2 Mouse Feature: MS_1 and MS_2 section.

*These two jumpers allow you to release the **IRQ12**, if you do not install a PS/2 mouse.*

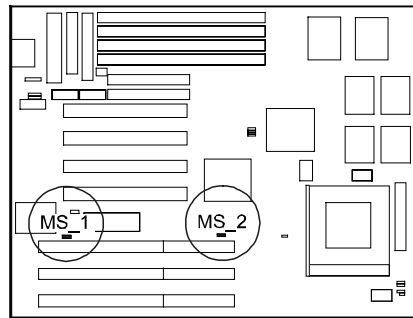

MS_1



Enable
(Default)



Disable

MS_2



Enable
(Default)



Disable

PCI2 ID: PCI2ID

This setting is provided to allow you to install more than one PCI add-on card released before the launch of the PCI Encoding Standard in 1993.

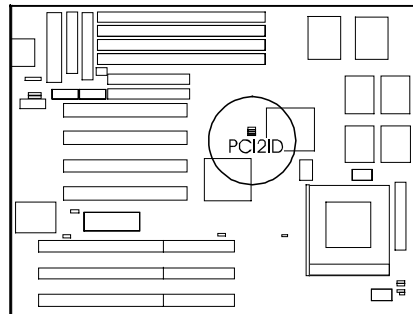

Disable
(Default)



Enable

NOTE : Please be aware that this feature is only provided for reasons of convenience and it is only in rare cases that the user needs to alter the default setting. Please consult your dealer for further information.

2). Install RAM Modules

DRAM Memory

The working space of the computer is the Random Access Memory (RAM). The system cannot act upon data unless it is loaded into RAM. The system RAM is comprised of industry-standard 72-pin Single In-line Memory Modules (SIMMs).

Occasionally the system must break apart data files because the entire file can not be fitted into the RAM area. Consequently, when the system needs data that is not in RAM, it must access the disk where the balance of the data is stored. Compared with the lightning speed accessing a RAM, accessing a mechanical disk drive is a much slower process.

Burst Extended Data Out (BEDO) and Extended Data Out (EDO) memory are the latest DRAM chip designs that perform a lot better than Fast Page Mode DRAM type. With BEDO and EDO memory, CPU access to memory is 10 to 15% faster.

When more RAM is added, the working area of the computer is larger, thereby increasing total performance. You should verify the type and speed of the RAM currently installed from your dealer. Mixtures of the RAM types, other than those described in this manual, will have unpredictable results.

The PA-2005 is able to support standard **FPM (Fast Page Mode), BEDO (Burst EDO), and EDO (Extended Data Out) DRAM**; and can accommodate onboard memory from 8 to 512MB using SIMMs. The mainboard has two memory banks, Bank 0 and Bank 1. Each bank has two SIMM sockets which can accept either a pair of **4MB, 8MB, 16MB, 32MB, 64MB, or 128MB** SIMM in each socket. Bank 0 and Bank 1 allow different types of SIMMs (e.g. 4MB or 16MB); however, you must populate each memory bank with the same type of SIMM.

RAM Module Configuration

TOTAL MEMORY	SIMM 1 & 2 (72-PIN X 2)	SIMM 3 & 4 (72-PIN X 2)
8MB	4MB & 4MB	
16MB	8MB & 8MB	
	4MB & 4MB	4MB & 4MB
24MB	8MB & 8MB	4MB & 4MB
32MB	8MB & 8MB	8MB & 8MB
	16MB & 16MB	
40MB	16MB & 16MB	4MB & 4MB
48MB	16MB & 16MB	8MB & 8MB
64MB	16MB & 16MB	16MB & 16MB
	32MB & 32MB	
72MB	32MB & 32MB	4MB & 4MB
80MB	32MB & 32MB	8MB & 8MB
96MB	32MB & 32MB	16MB & 16MB
128MB	32MB & 32MB	32MB & 32MB
	64MB & 64MB	
256MB	64MB & 64MB	64MB & 64MB
512MB	128MB* & 128MB*	128MB* & 128MB*

NOTE :

- 1, All memory banks use 72-pin memory modules.
2. * A SIMM of this size was not available for testing when this manual was printed.

Install SIMMs

Complete the following procedures to install SIMMs:

CAUTION :

1. Always turn the system power off before installing or removing any device.
2. Always observe static electricity precautions.
See "Handling Precautions" at the start of this manual.

1. Locate the SIMM slots on the mainboard. (See figure below.)

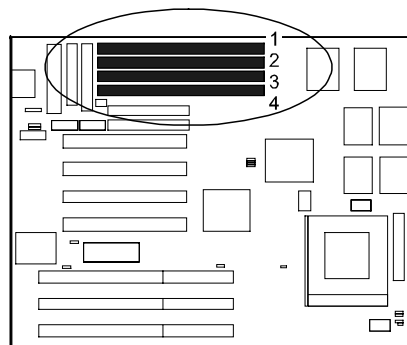

NOTE : SIMMs in each bank must be of the same type; and the BIOS automatically configures the memory size.

2. Carefully fit a SIMM at a 45 degree angle into each empty socket to be populated. All the SIMMs must face the same direction.

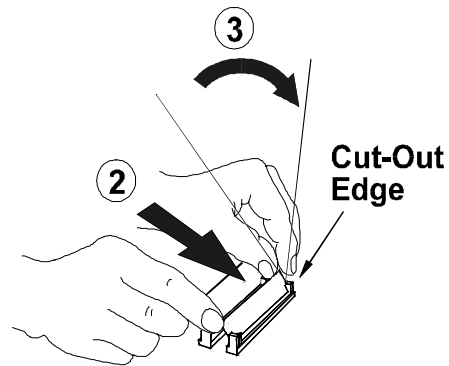

3. Swing each SIMM into its upright, locked position.
When locking a SIMM in place, push on each end of the SIMM - do not push in the middle, as shown above.

Remove SIMMs

To remove the SIMMs, pull the retaining latch on both ends of the socket and reverse the procedure above.

Cache Memory

Cache memory access is very fast compared to main memory access. The cache holds data for imminent use. Since cache memory is from five to more than ten times faster than main memory, the CPU's access time is reduced, giving you better system performance.

Pentium mainboards may implement various types of L2 cache SRAMs. Pipeline Burst SRAM is one of them, delivering the best price performance ratio. They perform much better than asynchronous SRAMs.

The PA-2005 comes with onboard 256KB/512KB/1MB synchronous 3V Pipeline Burst SRAMs. Please note that for 256KB secondary cache, M2 and M3 should be mounted with 32Kx32 Pipeline Burst SRAM. (Please refer to your dealer for the 512KB/1MB cache upgrade and the appropriate SRAM type.)

NOTE : Use the correct chips for the amount of cache memory you want to add. Install both the correct SRAM module and tag SRAM.

256KB Cache SRAM

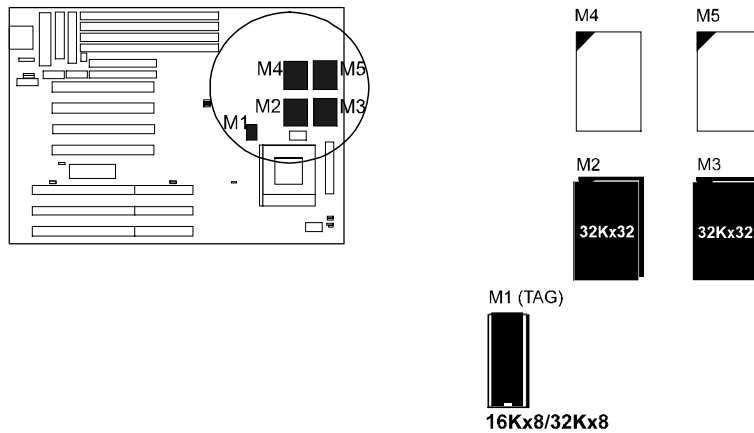

512KB Cache SRAM

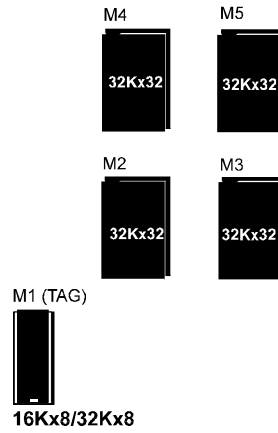

OR

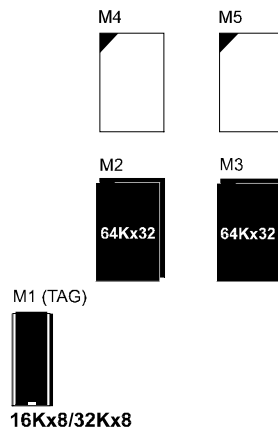

1MB Cache SRAM

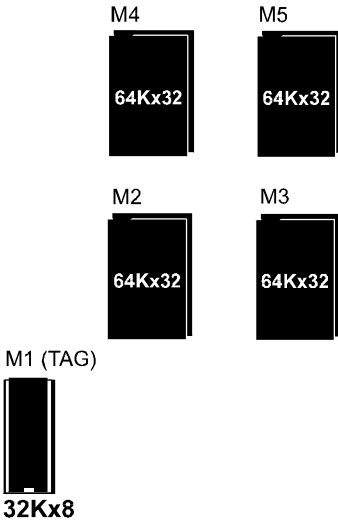
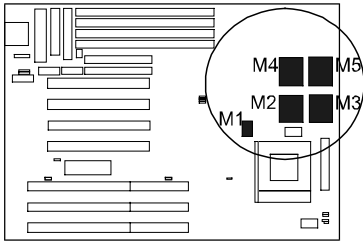

3). Install the CPU

The CPU module resides in the Zero Insertion Force (ZIF) socket on the mainboard.

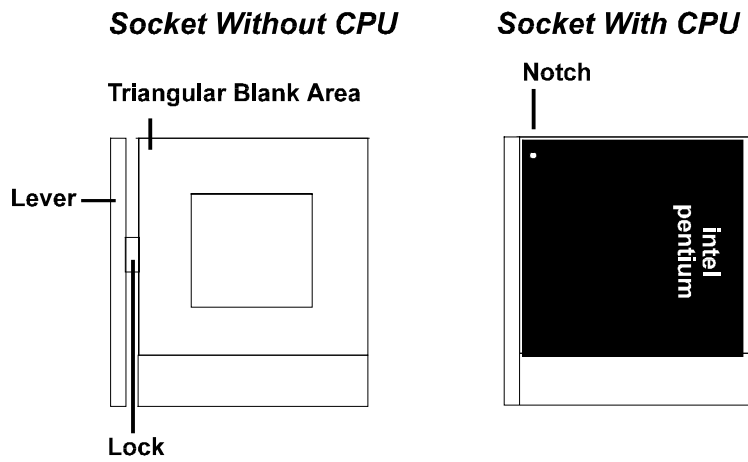
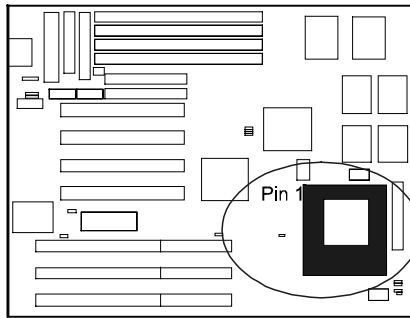

CAUTION :

1. Always turn the system power off before installing or removing any device.
2. Always observe static electricity precautions.
See "Handling Precautions" at the start of this manual.
3. Inserting the CPU chip incorrectly may damage the chip.









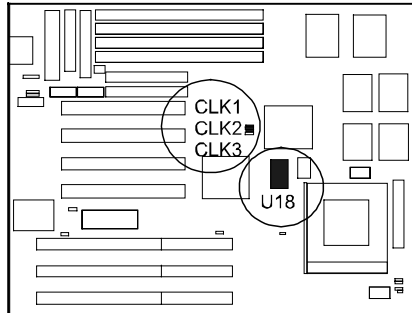









To install the CPU, do the following:

1. Lift the lever on the side of the CPU socket.
2. Handle the chip by its edges and try not to touch any of the pins.
3. Place the CPU in the socket. The chip has a notch to correctly orientate the chip. Align the notch with pin one of the socket. Pin one is located in the blank triangular area. Do not force the chip. The CPU should slide easily into the socket.
4. Swing the lever to the down position to lock the CPU in place.
5. See the following sections for information on the CPU jumpers settings.

CPU External Clock (BUS) Frequency: CLK1, CLK2, CLK3

The table below shows the jumper settings for the different CPU speed configurations.



CPU Speed	CLK1	CLK2	CLK3
75 MHz	 1	 1	 1
75 MHz	 1	 1	 1
66 MHz	 1	 1	 1
60 MHz	 1	 1	 1
55 MHz	 1	 1	 1
50 MHz	 1	 1	 1

The 75 MHz Settings in the left-hand side table is only for Cyrix 6x86-P200+ (150 MHz) and for IBM 6x86-P200+ (150 MHz).

← for PLL52C59-14TSC onboard (U18)







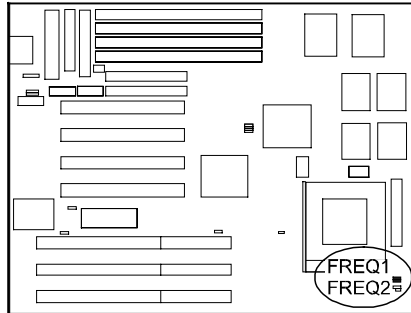

← for W48C60-234 onboard (U18)

If Jumper CLK3 is a 1x3 pin-header, the mainboard supports 75 MHz; otherwise, the jumper is wired, the mainboard does not support 75 MHz.

CPU to Bus Frequency Ratio: *FREQ1, FREQ2*









































These two jumpers are used in combination to decide the ratio of the internal frequency of the CPU to the bus clock.



FREQ1	FREQ2	Ratio		
		Intel	Cyrix	AMD
 1	 1	3 x	3 x	
 1	 1	2.5 x	2.5 x	1.75 x
 1	 1	2 x	2 x	2 x
 1	 1	1.5 x	3.5 x	1.5 x

Intel Pentium CPUs

Frequency

CPU Speed	External (CPU/CLK)	CLK1	CLK2	CLK3	CPU Clock Rate		
					Internal	FREQ1	FREQ2
200 MHz	66 MHz	 1	 1	 1	3 x	 1	 1
166 MHz	66 MHz	 1	 1	 1	2.5 x	 1	 1
150 MHz	60 MHz	 1	 1	 1	2.5 x	 1	 1
133 MHz	66 MHz	 1	 1	 1	2 x	 1	 1
120 MHz	60 MHz	 1	 1	 1	2 x	 1	 1
100 MHz	66 MHz	 1	 1	 1	1.5 x	 1	 1
90 MHz	60 MHz	 1	 1	 1	1.5 x	 1	 1
75 MHz	50 MHz	 1	 1	 1	1.5 x	 1	 1

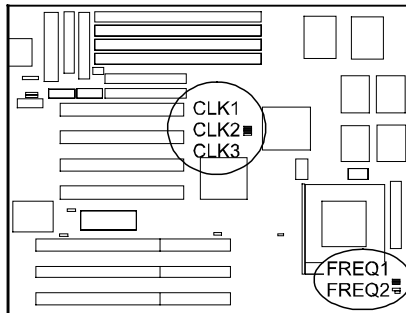

Voltage

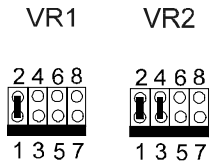

Core: 3.384V
IO : Same
P54C - STD, VR

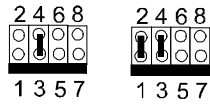

Core: 3.4V-3.6V
IO : Same
P54C - VRE

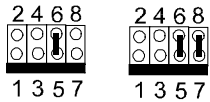

Core: 2.7V-2.9V
IO : 3.3V
P55C

**Intel Pentium CPU
Bottom Side Marking**

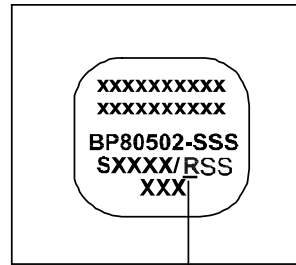



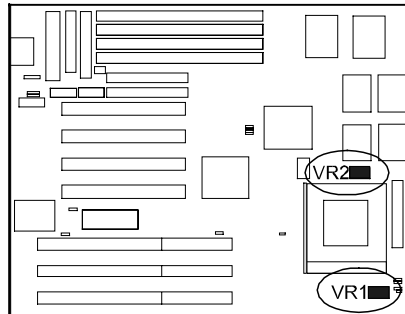















































R (Identifier for Voltage Range) :
V for VRE Voltage Range
or
S for Standard Voltage Range



AMD-K5/K6 CPUs

Frequency

Model Name	CPU Speed	External (CPU/CLK)	CLK1	CLK2	CLK3	CPU Clock Rate		
						Internal	FREQ1	FREQ2
K6-200	200 MHz	66 MHz	 1	 1	 1	3 x	 1	 1
K6-166	166 MHz	66 MHz	 1	 1	 1	2.5 x	 1	 1
K5-PR200	133 MHz	66 MHz	 1	 1	 1	2 x	 1	 1
K5-PR166	116 MHz	66 MHz	 1	 1	 1	1.75 x **	 1	 1
K5-PR150	105 MHz	60 MHz	 1	 1	 1	1.75 x **	 1	 1
K5-PR133	100 MHz	66 MHz	 1	 1	 1	1.5 x	 1	 1
K5-PR120	90 MHz	60 MHz	 1	 1	 1	1.5 x	 1	 1
K5-PR100	100 MHz	66 MHz	 1	 1	 1	1.5 x	 1	 1
K5-PR90	90 MHz	60 MHz	 1	 1	 1	1.5 x	 1	 1
K5-PR75	75 MHz	50 MHz	 1	 1	 1	1.5 x	 1	 1

NOTE : ** For AMD CPUs only, jumper FREQ1/FREQ2 can be set for 1.75x bus ratio.

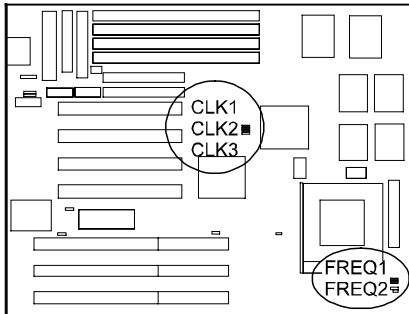

Voltage

VR1 VR2

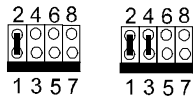

Core : 3.384V
IO : Same
AMD-K5 - C, F

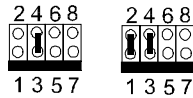

Core : 3.4V-3.6V
IO : Same
AMD-K5 - B

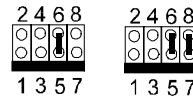

Core : 2.7V-2.9V
IO : 3.3V
AMD-K5 - H, J

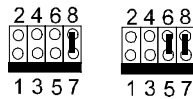

Core : 2.9V
IO : 3.3V
AMD-K5 - K
K6-166/200

**AMD-K5 CPU
Top Side Marking**

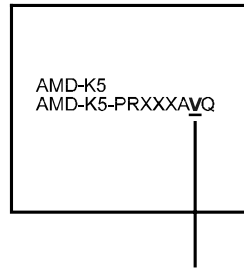

V (Identifier for Operation Voltage) :

B	H	Please refer to the left-hand-side table
C	J	
F	K	

**AMD-K6 CPU
Top Side Marking**

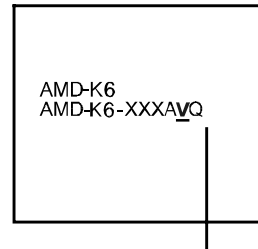





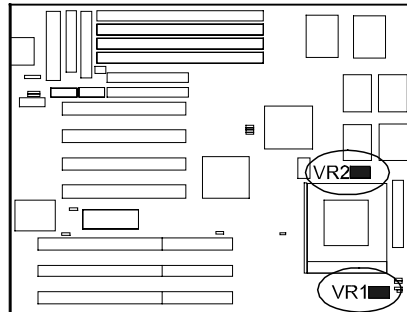





























V (Identifier for Operation Voltage) :

N	3.1-3.3V Core/3.135-3.6V I/O
L	2.755-3.045V Core/3.135-3.6V I/O



Cyrix 6x86/MX CPUs

Frequency

Model Name	CPU Speed	External (CPU/CLK)	CLK1	CLK2	CLK3	CPU Clock Rate		
						Internal	FREQ1	FREQ2
6x86MX-PR200*	166 MHz	66 MHz	 1	 1	 1	2.5 x	 1	 1
6x86MX-PR166*	150 MHz	60 MHz	 1	 1	 1	2.5 x	 1	 1
6x86-P200+ 6X86L-P200+	150 MHz	75 MHz ⁺	 1	 1	 1	2 x	 1	 1
6x86-P166+ 6x86L-P166+	133 MHz	66 MHz	 1	 1	 1	2 x	 1	 1
6x86-P150+ 6x86L-P150+	120 MHz	60 MHz	 1	 1	 1	2 x	 1	 1
6x86-P133+ 6x86L-P133+	110 MHz	55 MHz	 1	 1	 1	2 x	 1	 1
6x86-P120+ 6x86L-P120+	100 MHz	50 MHz	 1	 1	 1	2 x	 1	 1

NOTE :
 * This CPU had not been tested when this manual was printed.
 ** For Cyrix/IBM CPUs only, FREQ1/2 can be set for 3.5x bus ratio.
 + Please read Page 27 " CLK1, CLK2, CLK3".

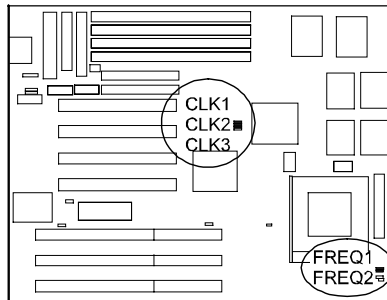

Voltage

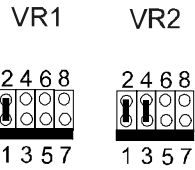

Core : 3.3V
IO : Same
Cyrix 6x86-016

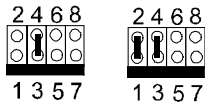

Core : 3.4V-3.6V
IO : Same
Cyrix 6x86-028

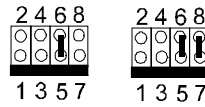

Core : 2.8V
IO : 3.3V
Cyrix 6x86L *

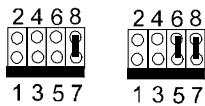

Core : 2.9V
IO : 3.3V
Cyrix 6x86MX

**Cyrix 6x86 CPU
 Top Side Marking**

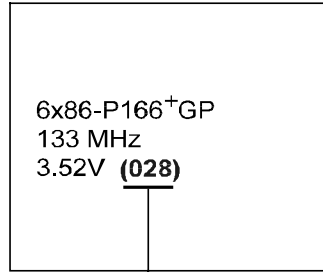



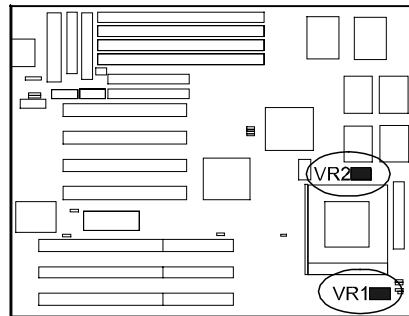































(016) : 3.3V
(028) : 3.52V



IBM 6x86/MX CPUs

Frequency

Model Name	CPU Speed	External (CPU/CLK)	CLK1	CLK2	CLK3	CPU Clock Rate		
						Internal	FREQ1	FREQ2
6x86MX-PR200*	166 MHz	66 MHz	 1	 1	 1	2.5 x	 1	 1
6x86MX-PR166*	150 MHz	60 MHz	 1	 1	 1	2.5 x	 1	 1
6x86-P200+ 6x86L-P200+	150 MHz	75 MHz [†]	 1	 1	 1	2 x	 1	 1
6x86-P166+ 6x86L-P166+	133MHz	66 MHz	 1	 1	 1	2 x	 1	 1
6x86-P150+ 6x86L-P150+	120 MHz	60 MHz	 1	 1	 1	2 x	 1	 1
6x86-P133+ 6x86L-P133+	110 MHz	55 MHz	 1	 1	 1	2 x	 1	 1
6x86-P120+ 6x86L-P120+	100 MHz	50 MHz	 1	 1	 1	2 x	 1	 1

NOTE :

* This CPU had not been tested when this manual was printed.

** For Cyrix/IBM CPUs only, FREQ1/2 can be set for 3.5x bus ratio.

+ Please read Page 27 " CLK1, CLK2, CLK3".

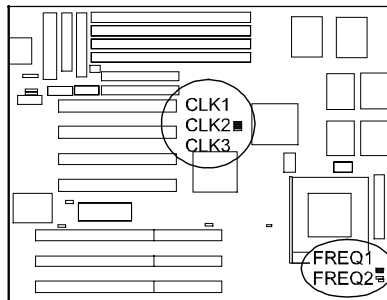

Voltage

VR1 VR2

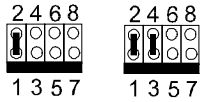

Core : 3.3V
IO : Same
IBM 6x86-016

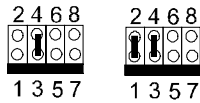

Core : 3.4V-3.6V
IO : Same
IBM 6x86-028

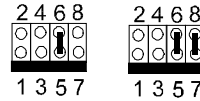

Core : 2.5V
IO : 3.3V
IBM 6x86L *

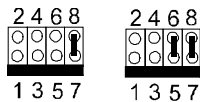

Core : 2.9V
IO : 3.3V
IBM 6x86MX

**IBM 6x86 CPU
 Top Side Marking**

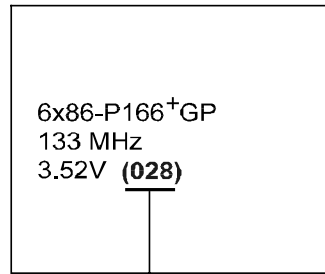

(016) : 3.3V

(028) : 3.52V

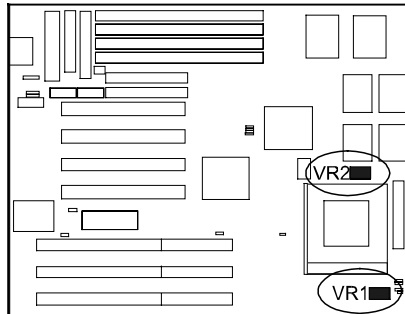

Installation of Cyrix (or IBM) 6x86 CPU Fan

CAUTION : When you install a Cyrix (or IBM) 6x86 CPU fan, please pay attention to the direction of the air flow. Make sure that it lowers the temperature of the regulator. Otherwise, the system may overheat.

We recommend that you use one of the following two CPU fans for the Cyrix (or IBM) 6x86 CPU when you install the fan on the mainboard.

- 1). Supplier : BIRCHTECK, Taiwan (Phone : 886-2-7935677)
Model Number - BEC6x86B1.
- 2). Supplier : Cyrix (or IBM). The fan comes with the Cyrix (or IBM) 6x86 CPU purchase. For the stable system performance, make sure that the air flow blow toward the regulator the temperature of the regulator.

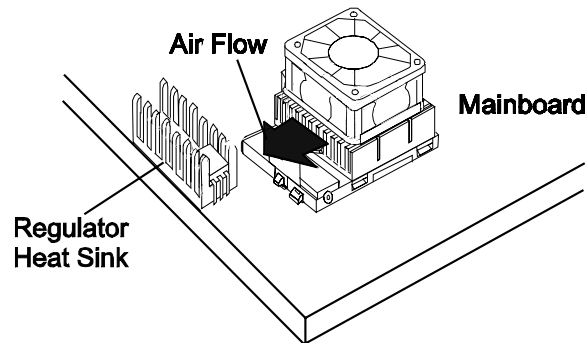

4). Install Expansion Cards

Your PA-2005 features four 16-bit ISA Bus and four 32-bit PCI Bus expansion slots.

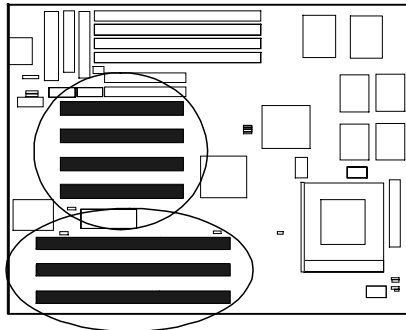

This section describes how to connect an expansion card to one of your system's expansion slots. Expansion cards are printed circuit boards that, when connected to the mainboard, increase the capabilities of your system. For example, expansion cards can provide video and sound capabilities.

<p>CAUTION :</p> <ol style="list-style-type: none">1. Always turn the system power off before installing or removing any device.2. Always observe static electricity precautions. See "Handling Precautions" at the start of this manual.

To install an expansion card, do the following:

1. Remove the chassis cover and select an empty expansion slot.
2. Remove the corresponding slot cover from the chassis.
Unscrew the mounting screw that secures the slot cover and pull the slot cover out from the chassis. Keep the slot cover mounting screw nearby.

3. Holding the edge of the peripheral card, carefully align the edge connector with the expansion slot. (See figure below.)

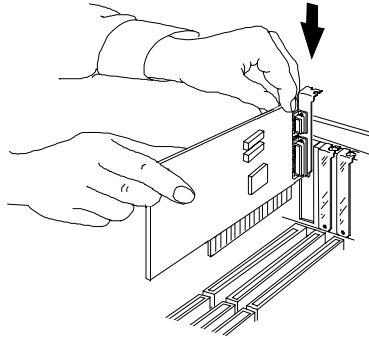

4. Push the card firmly into the slot. Push down on one end of the expansion card, then the other. Use this “rocking” motion until the add-in card is firmly seated inside the slot.
5. Secure the board with the mounting screw removed in Step 2. Make sure that the card has been placed evenly and completely into the expansion slot.

5). Connect Cables and Power Supply

Keyboard Connector: AT_KB

This 5-pin female connector is used for your 101-key enhanced keyboard or 106-key Windows 95 keyboard.

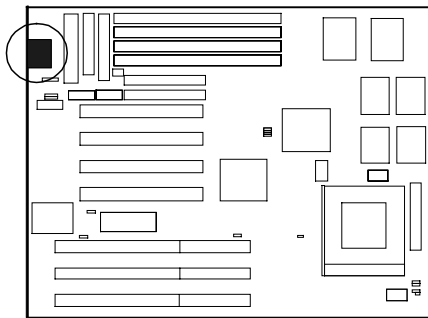

Serial Port Connector: COM1 and COM2

These two 10-pin male connectors allow you to connect with your devices that take serial ports, such as a serial mouse or a modem. The COM2 Port on the PA-2005 mainboard can also be used as another IR Port. Usually, your serial mouse is attached to COM1. Your modem is linked to COM2. When you do not use the modem, you can set the BIOS to let COM2 be an IR port to save a dedicated SIR port.

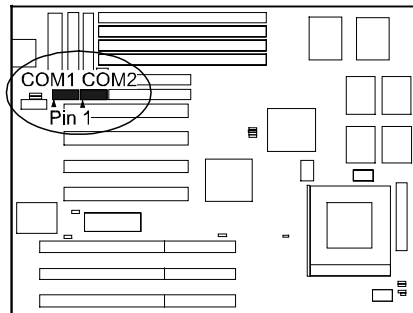

CPU Fan Connector: FAN

This connector is linked to the CPU fan.

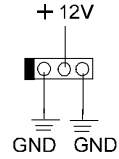
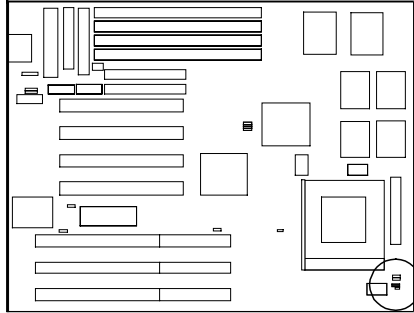

Floppy Diskette Drive Connector: FLOPPY

This 34-pin block connector connects to your floppy diskette drive (FDD) using the cable that is provided with this mainboard.

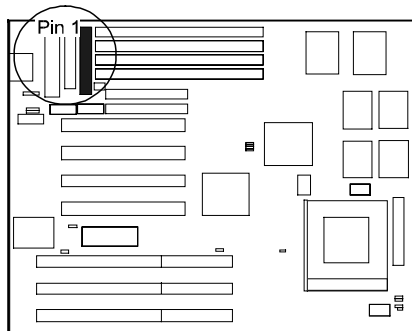

Front Panel Block Connector: F_PNL

This block connector includes: PW_LED, KB_LOCK, TB_LED, SP_SW, SPK, SP_LED, IDE_LED, RPW_SW, and RST connectors.

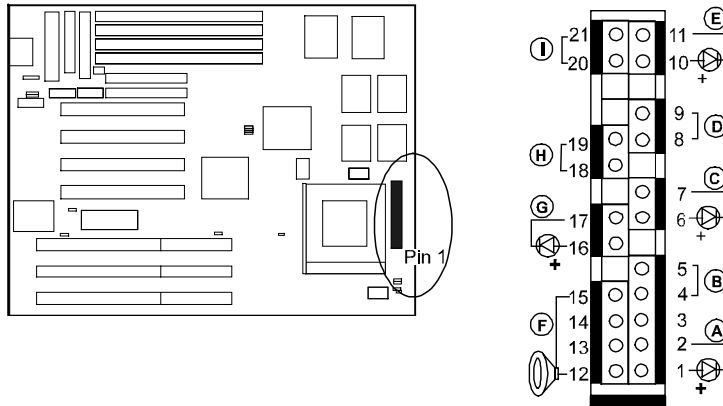

Item	Connector	Pin Type	Feature
A	PW_LED	2-pin male	indicates the system power status
B	KB_LOCK	2-pin male	allows the keyboard to access the system
C	TB_LED	2-pin male	indicates the system speed is in normal or turbo speed
D	SP_SW	2-pin male	Suspend mode switch
E	SP_LED	2-pin male	indicates the system into Suspend mode when LED lit
F	SPK	4-pin male	connects to speaker
G	IDE_LED	2-pin male	indicates the IDE HDD I/O access LED lit
H	RPW_SW	2-pin male	remote power switch
I	RST	2-pin male	allows you to reset the system

IDE HDD Device Connector: PRIMARY and SECONDARY

These two 40-pin block connectors are used for your IDE hard disks. If you have one IDE hard disk, connect it to the PRIMARY connector using the IDE HDD flat cable provided with the mainboard. The BIOS auto detection sets it to be a **Primary Master** disk. If you want to install another IDE hard disk or CD-ROM, please use the SECONDARY connector. If two hard disks are connected to the PRIMARY connector using the same cable, one of them is the master drive, the other one is the slave drive. You may need to set jumpers for the slave drive; please refer to the HDD manual for details.

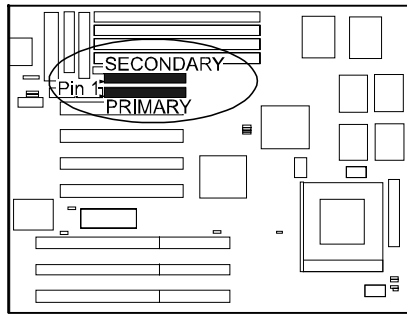

Infrared Connector: IR

This 10-pin male connector is used for connecting to the infrared (SIR) port and allows transmission of data to another system which also supports the SIR feature.

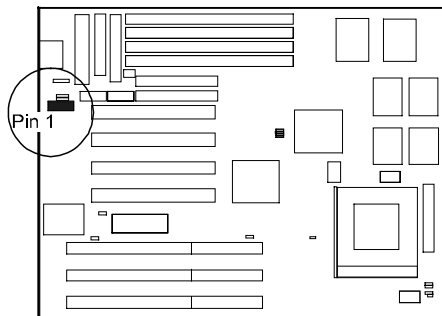

Outlet Connector: OUTLET

This 2-pin male connector is used for connecting to the system power supply for enabling (disabling) the power output from the direct connection of the system power supply. (This feature is designed for monitors without DPMS mode support and only applies if the monitor is directly connected to the system power supply.)

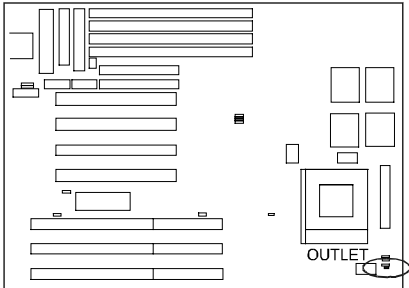

PS/2 Mouse Connector: MS_CON

This connector is connected to the PS/2 mouse. Please read **Page 17**, also.

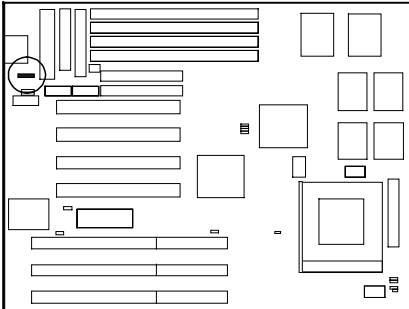

Standard Power Connector: POWER

This 12-pin block connector is used for connecting to the standard 5V power supply. In the picture below, notice that, in most cases, there are two marks **P8** and **P9** on the surface of the connector. You have to insert the **P8** plug into the **P8** section of the connector, and so forth for **P9**. Two black wires must be in the middle.

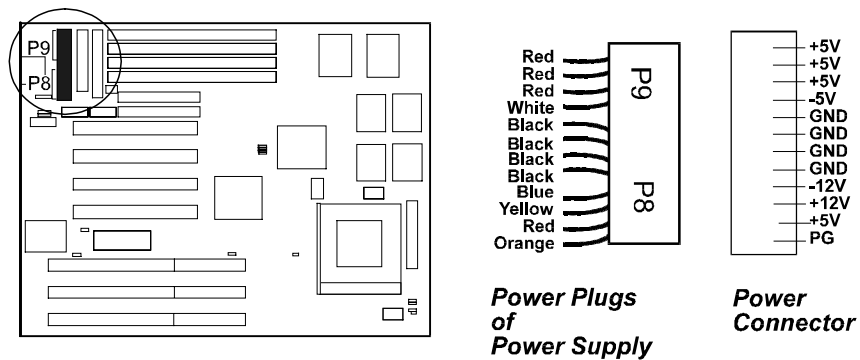

Printer Connector: PRINTER

This 26-pin male block connector is attached to your printer via a cable. When inserting the cable, please be sure that the red line is always on the same side as pin 1 of this connector.

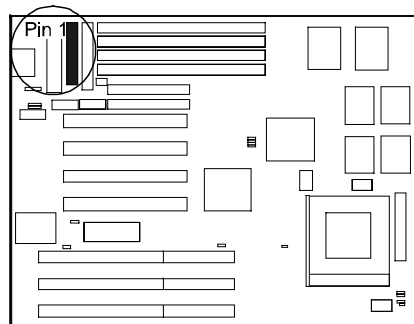

Remote Power Supply Connector: RPW_CON

This 3-pin male connector allows you to enable (or disable) the system power if the RPW_SW is on (or off).

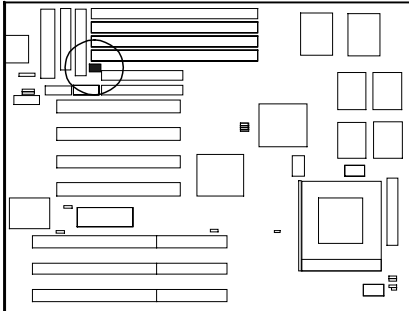

Universal Serial Bus Connectors (reserved for future upgrade)

This connects to the port that allows you to attach a USB hub. The USB connectors are built-in for future upgrade of devices or peripherals that support Universal Serial Bus features.

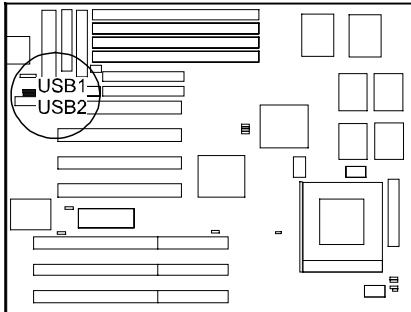

Award BIOS Setup Utility	
BIOS : 090408 8 0104 0000	Serial LS : CMOS00000000
ESCP : 0000	↑ ↓ ← → : Setup Menu
LOAD SETUP DEFAULTS	EXIT SETUP CHANGES
LOAD BIOS DEFAULTS	SAVE & EXIT SETUP
NO CMOS BATTERY BATTERY	PREVIOUS VALUES DELETED
ADJUST POWER MGMT. SETUP	POWER MGMT. SETUP
CHARGE LIMITING SETUP	POWER MGMT. SETUP
BIOS SECURITY SETUP	POWER MGMT. SETUP
ADJUST CMOS SETUP	POWER MGMT. SETUP
AWARD BIOS SETUP UTILITY	
CMOS SETUP HELP	
HOW TO USE HELP	

Chapter 3

Award BIOS Setup

The mainboard comes with the Award BIOS chip that contains the ROM Setup information of your system. This chip serves as an interface between the processor and the rest of the mainboard’s components. This chapter explains the information contained in the Setup program and tells you how to modify the settings according to your system configuration.

CMOS Setup Utility

A Setup program, built into the system BIOS, is stored in the CMOS RAM that allows the configuration settings to be changed. This program is executed when the user changes system configuration; the user changes system backup battery; or the system detects a configuration error and asks the user to run the Setup program. At power-on RAM testing, the message **Press DEL to enter Setup** appears. Use the arrow keys to select and press **Enter** to run the selected program.

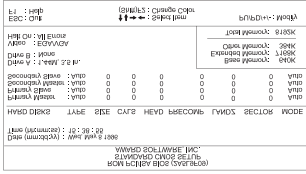

Standard CMOS Setup

The Standard CMOS Setup screen is displayed above. System BIOS automatically detects memory size, thus no changes are necessary. It has a few items for setting. Each item may have one or more option settings. It allows you to change the system Date and Time, IDE hard disk, floppy disk drive types for drive A: and B:, boot up video display mode, and POST error handling selection. Use the arrow keys to highlight the item and then use the **PgUp**, or **PgDn** keys to select the value you want in each item.

Hard Disk Configurations

TYPE:

Select from **1** to **45** to fill remaining fields with predefined values of disk drives. Select User to fill the remaining fields. Select **Auto** to detect the HDD type automatically.

SIZE:

The hard disk size. The unit is Mega Bytes.

CYLS:

The cylinder number of the hard disk.

HEAD:

The read/write head number of hard disk. The range is from 1 to 16.

PRECOMP:

The cylinder number at which the disk drive changes the write timing.

LANDZ:

The cylinder number that the disk drive heads (read/write) are seated when the disk drive is parked.

SECTOR:

The sector number of each track defined on the hard disk. The range is from 1 to 64.

MODE:

Select **Auto** to detect the mode type automatically. If your hard disk supports the LBA mode, select **LBA** or **Large**. However, if your hard disk cylinder is more than 1024 and does not support the LBA function, you have to set at **Large**. Select **Normal** if your hard disk supporting cylinders is below 1024.

Software Turbo Speed

The BIOS supports Software Turbo Speed feature. Instead of pressing the Turbo Speed Button on the front panel, simply press the **Alt**, **Ctrl**, and **+** keys at the same time to enable the Turbo Speed feature; and press the **Alt**, **Ctrl**, and **-** keys at the same time to disable the feature.

BIOS Features Setup

ROM PCI/ISA BIOS (2A5L9F09) BIOS FEATURES SETUP AWARD SOFTWARE, INC.	
Virus Warning : Disabled	Video BIOS Shadow : Enabled
CPU Internal Cache : Enabled	C8000 - CFFFF Shadow : Disabled
External Cache : Enabled	CC000 - CFFFF Shadow : Disabled
Quick Power On Self Test : Disabled	D0000 - D3FFF Shadow : Disabled
Boot Sequence : A, C	D4000 - D7FFF Shadow : Disabled
Swap Floppy Drive : Disabled	D8000 - DBFFF Shadow : Disabled
Boot Up Floppy Seek : Enabled	DC000 - DFFFF Shadow : Disabled
Boot Up NumLock Status : On	
Port 82H Fast A20E : Fast	
Typeomatic Rate Setting : Disabled	
Typeomatic Rate (Chars/Sec) : 6	
Typeomatic Delay (Msec) : 250	
Security Option : Setup	ESC : Quit ↑ ↓ → ← : Select Item
PCI/VGA Palette Snoop : Disabled	F1 : Help PU/PD,+/- : Modify
OS Select For DRAM > 64MB : Non-OS2	F5 : Old Values (Shift) F2 : Color
	F6 : Load BIOS Defaults
	F7 : Load Setup Defaults

Moving around the BIOS and Chipset Features (refer to the next section) Setup programs shown works the same way as moving around the Standard CMOS Setup program. Users are not encouraged to run the BIOS and Chipset Features Setup programs. Your system should have been fine-tuned before shipping. Improper Setup may cause the system to fail, consult your dealer before making any changes.

Virus Warning

When enabled, assigns the BIOS to monitor the master boot sector and the DOS boot sector of the first hard disk drive.
The options are: Enabled, Disabled (Default).

CPU Internal Cache

When enabled, improves the system performance. Disable this item when testing or trouble-shooting.
The options are: Enabled (Default), Disabled.

External Cache

When enabled, supports an optional cache SRAM.
The options are: Enabled (Default), Disabled.

Quick Power On Self Test

When enabled, allows the BIOS to bypass the extensive memory test.
The options are: Enabled, Disabled (Default).

Boot Sequence

Allows the system BIOS to first try to boot the operating system from the selected disk drive.

The options are: A, C (Default); C, A; C, CDROM, A; CDROM, C, A.

Swap Floppy Drive

When enabled, allows you to switch the order in which the operating system accesses the floppy drives during boot up.

The options are: Enabled, Disabled (Default).

Boot Up Floppy Seek

When enabled, assigns the BIOS to perform floppy diskette drive tests by issuing the time-consuming seek commands.

The options are: Enabled (Default), Disabled.

Boot Up Numlock Status

When set to On, allows the BIOS to automatically enable the Num Lock Function when the system boots up.

The options are: On (Default), Off.

Port 92H Fast A20G

When enabled, allows the A20G bus line signal generated from the chipset 82C586 PC/AT to directly pass to port 92H, instead of the keyboard controller. It will speed up the system performance.

The options are: Fast (Default), Normal.

Typematic Rate Setting

The term **typematic** means that when a keyboard key is held down, the character is repeatedly entered until the key is released. When this item is enabled, you may change the typematic repeat rate.

The options are: Disabled (Default), Enabled.

Typematic Rate (Chars/Sec)

Sets the rate of a character repeat when the key is held down.

The options are: 6 (Default), 8, 10, 12, 15, 20, 24, 30.

Typematic Delay (Msec)

Sets the delay time before a character is repeated.

The options are: 250 (Default), 500, 750, 1000 millisecond.

Security Option

Allows you to set the security level of the system.
The options are: Setup (Default), System.

PCI/VGA Palette Snoop

When enabled, allows you install an enhanced graphics adapter card. If your graphics adapter card does not support the Palette Snoop function, please set at Disable to avoid system malfunctions.
The options are: Enabled, Disabled (Default).

OS Select For DRAM > 64MB

If your operating system (OS) is OS2, select the options **OS2**; otherwise, stay with the default setting **Non-OS2**.
The options are: Non-OS2 (Default), OS2.

Video BIOS Shadow

When enabled, allows the BIOS to copy the video ROM code of the add-on video card to the system memory for faster access.
The options are: Enabled (Default), Disabled.

C8000-CBFFF to DC000-DFFFF Shadow

When enabled, allows the BIOS to copy the BIOS ROM code of the add-on card to system memory for faster access. It may improve the performance of the add-on card. Some add-on cards will not function properly if its BIOS ROM code is shadowed. To use these options correctly, you need to know the memory address range used by the BIOS ROM of each add-on card.
The options are: Enabled, Disabled (Default).

Chipset Features Setup

ROM PCI/ISA BIOS (2A5L9F09) CMOS SETUP UTILITY CHIPSET FEATURES SETUP			
Video BIOS Cacheable	: Enabled	Onboard FDD Control	: Enabled
System BIOS Cacheable	: Disabled	Onboard Serial Port 1	: 3F8/IRQ4
Memory Hole At 15Mb Addr.	: Disabled	Onboard Serial Port 2	: 2F8/IRQ3
		UART 2 Mode	: Standard
Sustained 3T write	: Enabled		
CPU Pipeline	: Enabled		
DRAM Timing Control	: Fast	Onboard Parallel Port	: 378H/IRQ7
Enhanced Page Mode	: Enabled	Onboard Parallel Mode	: SPP
OnChip IDE first channel	: Enabled		
OnChip IDE second channel	: Enabled		
IDE Prefetch	: Enabled		
IDE HDD Block Mode	: Enabled		
IDE Primary Master PIO	: Auto	ESC : Quit	↑ ↓ → ← : Select Item
IDE Primary Slave PIO	: Auto	F1 : Help	PU/PD/+/- : Modify
IDE Secondary Master PIO	: Auto	F5 : Old Values (Shift) F2 : Color	
IDE Secondary Slave PIO	: Auto	F6 : Load BIOS Defaults	
		F7 : Load Setup Defaults	

Video BIOS Cacheable

When enabled, allows the system to use the video BIOS codes from SRAMs, instead of the slower DRAMs or ROMs.

The options are: Enabled (Default), Disabled.

System BIOS Cacheable

When enabled, allows the ROM area F000H-FFFFH to be cacheable when cache controller is activated.

The options: Enabled, Disabled (Default).

The recommended setting is Disabled especially for high speed CPUs (200 MHz and above).

Memory Hole At 15MB Addr.

When enabled, the memory hole at the 15MB address will be relocated to the 15~16MB address range of the ISA cycle when the processor accesses the 15~16MB address area.

When disabled, the memory hole at the 15MB address will be treated as a DRAM cycle when the processor accesses the 15~16MB address.

The options: Enabled, Disabled (Default).

Sustained 3T Write

When enabled, allows the CPU to complete the memory writes in 3 clocks.

The options: Enabled (Default), Disabled.

CPU Pipeline

When enabled, allows the CPU to execute the pipeline function.
The options: Enabled (Default), Disabled.

DRAM Timing Control

Allows you to speed up the data access of 82C586.
The options: Normal, Fast (Default), Turbo.

Enhanced Page Mode

When enabled, it allows the system BIOS to pre-determine the next access is on or off page. This leads the start of precharge time if off page.
The options: Enabled (Default), Disabled.

OnChip IDE First Channel

When enabled, allows the IDE drive to use the first channel of the primary IDE.
The options: Enabled (Default), Disabled.

OnChip IDE Second Channel

When enabled, allows the IDE drive to use the second channel of the primary IDE.
The options are: Enabled (Default), Disabled.

IDE Prefetch

When enabled, allows the BIOS to utilize the prefetch buffer of the onboard IDE controller to prefetch the next sequential data of the current access.
The options are: Enabled (Default), Disabled.

IDE HDD Block Mode

When enabled, allows the system to execute read/write requests to hard disk in block mode.
The options are: Enabled (Default), Disabled.

IDE Primary Master PIO

Allows you to select first PCI IDE channel of the primary master hard disk mode or to detect it by the BIOS.
The options are: Auto (Default), Mode 0, Mode 1, Mode 2, Mode 3, Mode 4.

IDE Primary Slave PIO

Allows you to select the first PCI IDE channel of the primary slave hard disk mode or to detect it by the BIOS.

The options are: Auto (Default), Mode 0, Mode 1, Mode 2, Mode 3, Mode 4.

IDE Secondary Master PIO

Allows you to select first PCI IDE channel of the primary master hard disk mode or to detect it by the BIOS.

The options are: Auto (Default), Mode 0, Mode 1, Mode 2, Mode 3, Mode 4.

IDE Secondary Slave PIO

Allows you to select the first PCI IDE channel of the primary slave hard disk mode or to detect it by the BIOS.

The options are: Auto (Default), Mode 0, Mode 1, Mode 2, Mode 3, Mode 4.

Onboard FDD Control

When enabled, the floppy diskette drive (FDD) controller is activated. The options are: Enabled (Default), Disabled.

Onboard Serial Port 1

If the serial port 1 uses the onboard I/O controller, you can modify your serial port parameters. If an I/O card needs to be installed, COM3 and COM4 may be needed.

The options are: 3F8/IRQ4 (Default), 3F8/IRQ4, 2E8/IRQ3, 2F8/IRQ3, Disabled.

Onboard Serial Port 2

If the serial port 2 uses the onboard I/O controller, you can modify your serial port parameters. If an I/O card needs to be installed, COM3 and COM4 may be needed.

The options are: 2F8/IRQ3 (Default), 3E8/IRQ4, 2E8/IRQ3, 3F8/IRQ4, Disabled.

UART 2 Mode

Allows you to select the IR modes if the serial port 2 is used as an IR port. Set at Standard, if you use COM2 as the serial port, instead as an IR port.

The options are: HPSIR, ASKIR, Standard (Default).

IR Function Duplex

Allows you to select the infrared transaction modes.
The options are: Half (Default), Full.

RxD , TxD Active

Allows you to select the active level of the reception end (RxD) and transmission end (TxD). The Hi stands for Active, the Lo stands for Non-active.
The options are: Hi, Hi (Default); Hi, Lo; Lo, Hi; Lo, Lo.

Onboard Parallel Port

Allows you to select from a given set of parameters if the parallel port uses the onboard I/O controller.
The options are: 378H/IRQ7 (Default), 278H/IRQ5, 3BCH/IRQ7, Disabled.

Onboard Parallel Mode

Allows you to connect with an advanced printer I/O mode.
The options are: SPP (Default), EPP, ECP, ECP/EPP.

ECP Mode Use DMA 3

Allows you to select the DMA channel number 3 or 1 for the ECP printer mode.
The options are: 1, 3 (Default).

Parallel Port EPP Type

Allows you to select the EPP version.
The options are: EPP1.7, EPP1.9 (Default).

IMPORTANT : I/O port 240h is reserved for the onboard Winbond I/O chip. Devices requiring I/O port address should not use port 240h.

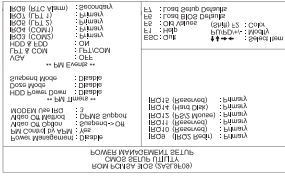

Power Management Setup

Power Management

When enabled, allows you to use Power Management features.
 The options are: Enabled, Disabled (Default).

PM Control by APM

The option **No** allows the BIOS to ignore the APM (Advanced Power Management) specification. Selecting **Yes** will allow the BIOS wait for APM's prompt before it enters Doze mode, Standby mode, or Suspend mode. If the APM is installed, it will prompt the BIOS to set the system into the power saving mode after all tasks are done.
 The options are: Yes (Default), No.

Video Off Option

This feature provides the selections of the video display power saving mode. The option **Suspend - Off** allows the video display to go blank if the system enters Suspend mode. The option **All Modes - Off** allows the video display to go blank if the system enters Doze mode or Suspend mode. The option **Always On** allows the video display to stay in Standby mode even when the system enters Doze or Suspend mode.
 The options are: Suspend - Off (Default), All Modes - Off, Always On.

Video Off Method

The option **V/H SYNC+Blank** allows the BIOS to blank off screen display by turning off the V-Sync and H-Sync signals sent from add-on VGA card.

DPMS Support allows the BIOS to blank off screen display by your add-on VGA card which supports DPMS (Display Power Management Signaling function.) **Blank Screen** allows the BIOS to blank screen display by turning off the red-green-blue signals.

The options are: DPMS Support (Default), V/H SYNC+Blank, Blank Screen.

MODEM Use IRQ

This feature allows you to select the IRQ# to meet your modem's IRQ#.

The options are: NA, 3 (Default), 4, 5,7, 9, 10, 11.

HDD Power Management

Selecting **Disabled** will turn off the hard disk drive (HDD) motor. Selecting **1 Min..15Min** allows you to define the HDD idle time before the HDD enters Power Saving Mode. The option **When Suspend** lets the BIOS turn the HDD motor off when the system is in Suspend mode.

The options **1 Min..15Min** and **When Suspend** will not work concurrently. When HDD is in Power Saving Mode, any access to the HDD will wake the HDD up.

The options are: Disabled (Default), 1 Min..15 Min, When Suspend.

Doze Mode

When disabled, the system will not enter Doze mode. The specified time option defines the idle time the system takes before it enters Doze mode.

The options are: Disabled (Default), 10, 20, 30, 40 sec, 1, 2, 4, 6, 8, 10, 20, 30, 40 min, 1h.

Suspend Mode

When disabled, the system will not enter Suspend mode. The specified time option defines the idle time the system takes before it enters Suspend mode.

The options are: Disabled (Default), 10, 20, 30, 40 sec, 1, 2, 4, 6, 8, 10, 20, 30, 40 min, 1h.

VGA

Selecting **ON** will enable the power management timers when a *no activity* events is detected in the VGA. Selecting **OFF** to disable the PM timer even if a *no activity* event is detected.

The options are: OFF (Default), ON.

LPT & COM

Selecting **LPT & COM** will enable the power management timers when a *no activity* event is detected in the LPT and COM ports. Selecting **LPT (COM)** will enable the power management timers when a *no activity* event is detected in the **LPT (COM)** ports. Selecting **NONE** to disable the PM timer even if a *no activity* event is detected.

The options are: LPT & COM (Default), LPT, COM, NONE.

HDD & FDD

Selecting **ON** will enable the power management timers when a *no activity* event is detected in the hard disk drive and floppy disk drive. Selecting **OFF** to disable the PM timer even if a *no activity* event is detected.

The options are: OFF, ON (Default).

IRQ# Activity

After the time period which you set at in Suspend Mode Feature, the system advances from Doze Mode to Suspend Mode in which the CPU clock stops and the screen display is off. At this moment, if the IRQ activity which is defined as **Primary** occurs, the system goes back to Full-on Mode directly.

If the IRQ activity which is defined as **Secondary** takes place, the system enters another low power state, Dream Mode, in which the system will act as Full-on Mode except that the screen display remains off until the corresponding IRQ handler finishes, then back to Suspend Mode. For instance, if the system connects to a LAN and receives an interruption from its file server, the system will enter the dreaming mode to execute the corresponding calling routine.

The options are: Primary, Secondary. The default values of IRQ3, 4, 5, 7, 9, 10, 11, 12, 14, 15 are: Primary. The default value of IRQ8 is: Secondary.

<p>NOTE : Under certain operating system such as Windows NT 4.0 (Build 1381), the CD auto-insertion feature might have some effect on the power management. It is recommended that the CD-ROM drive to use the secondary channel, and set the following features in the feature Power Management Setup. - HDD & FDD : Off ; IRQ15 (Reserved) : Secondary</p>

PCI Burst

When enabled, data transfer on PCI Buses will improve. Disable this item during trouble-shooting.

The options are: Disabled, Enabled (Default).

PCI Master 0 WS Write

When enabled, allows a zero-wait-state-cycle delay when the PCI master drive writes data to DRAM.

The options are: Enabled (Default), Disabled.

Quick Frame Generation

When enabled, allows the system to start the PCI Bus (by asserting frame) as soon as possible when the bus cycle is going to forward to the PCI Bus.

The options are: Disabled, Enabled (Default).

PnP Configuration Setup

ROM PCI/ISA BIOS (2A5L9F09) PNP CONFIGURATION SETUP AWARD SOFTWARE, INC.	
Resources Controlled By : Auto Reset Configuration Data : Disabled	PNP OS Installed : No Assign IRQ For VGA : Enabled
ESC : Quit ↑ ↓ → ← : Select Item F1 : Help PU/PD +/- : Modify F5 : Old Values (Shift) F2 : Color F6 : Load BIOS Defaults F7 : Load Setup Defaults	

Resources Controlled By

If you set at Auto, the BIOS automatically arranges all system resources for you. If there are conflicts or you are not satisfy with the configuration, simply set all the resources listed in the above figure by selecting Manual.

The options are: Auto (default), Manual.

The manual options of **IRQ- / DMA- assigned to** are: Legacy ISA, PCI/ISA PnP.

Reset Configuration Data

When enabled, this feature allows the system to clear the last BIOS configuration data and reset them with the default BIOS configuraton data.

The options are: Enabled, Disabled (default).

PNP OS Installed

If the operating system (OS) you installed supports PNP (Plug-and-Play), such as Windows 95, please select Yes; otherwise, stay with the default value, Disabled.

The options are: No, Yes (default).

Assign IRQ For VGA

If your PCI VGA card does not need an IRQ, select Disabled; therefore, an IRQ can be released for the system use.

The options are: Enabled (Default), Disabled.

Load BIOS Defaults

The BIOS defaults contain the most appropriate values of the system parameters that allow minimum system performance. The OEM manufacturer may change the defaults through MODBIN before the binary image burns into the ROM.

Load Setup Defaults

Selecting this field loads the factory defaults for BIOS and Chipset Features which the system automatically detects.

Supervisor/User Password

To enable the Supervisor/User passwords, select the item from the Standard CMOS Setup. You will be prompted to create your own password. Type your password up to eight characters and press **Enter**. You will be asked to confirm the password. Type the password again and press **Enter**. You may also press **Esc** to abort the selection and not enter a password. To disable password, press **Enter** when you are prompted to enter password. A message appears, confirming the password is disabled.

Under the BIOS Feature Setup, if **System** is selected under the Security Option field and the Supervisor Password is enabled, you will be prompted for the Supervisor Password every time you try to enter the CMOS Setup Utility. If **System** is selected and the User Password is enabled, you will be requested to enter the User Password every time you reboot the system. If **Setup** is selected under the Security Option field and the User Password is enabled, you will be prompted only when you reboot the system.

IDE HDD Auto Detection

The IDE Hard Disk Drive Auto Detection feature automatically configures your new hard disk. Use it for a quick configuration of new hard drives. This feature allows you to set the parameters of up to four IDE HDDs. The option(s) with (Y) is recommended by the system BIOS. You may also key in your own parameters instead of setting by the system BIOS. After all settings, press Esc key to return the main menu. For confirmation, enter the Standard CMOS Setup feature.

ROM PC/MISA BIOS (2A5L9F09) STANDARD CMOS SETUP AWARD SOFTWARE, INC.								
HARD DISKS	TYPE	SIZE	CYLS	HEAD	PRECOMP	LANDZ	SECTOR	MODE
Primary Master :								
Select Primary Master Option (N=SMp) : N								
OPTIONS	SIZE	CYLS	HEAD	PRECOMP	LANDZ	SECTOR	MODE	
2 (Y)	851	825	32	0	1650	63	LBA	
1	852	1651	16	65535	1650	63	NORMAL	
3	851	825	32	65535	1650	63	LARGE	

Note : Some OSes (like SCO-UNIX) must use "NORMAL" for installation



Save and Exit Setup

After you have made changes under Setup, press **Esc** to return to the main menu. Move cursor to Save and Exit Setup or press **F10** and then press **Y** to change the CMOS Setup. If you did not change anything, press **Esc** again or move cursor to Exit Without Saving and press **Y** to retain the Setup settings. The following message will appear at the center of the screen to allow you to save data to CMOS and exit the setup utility: **SAVE to CMOS and EXIT (Y/N)?**

Exit without Saving

If you select this feature, the following message will appear at the center of the screen to allow you to exit the setup utility without saving CMOS modifications: **Quit Without Saving (Y/N)?**

NOTE : Default values of the various Setup items on this chapter may not be the same ones shown on your screen.

This Page Intentionally Left Blank

Application Note

Below are some recommended configurations for the BIOS utility that will allow your mainboard to perform efficiently when using certain devices or when under a particular environment.

1. Page 54, Onboard Parallel Mode Feature:
The I/O port 240h is reserved for the onboard Winbond I/O chip. Devices requiring the I/O port address should not use port 240h.

2. Page 57, IRQ# Activity Feature:
Under certain operating systems such as Windows NT 4.0 (Build 1381), the CD auto-insertion feature might have some effect on the power management. It is recommended that the CD-ROM drive uses the secondary channel, and set the following features in the feature Power Management Setup -
HDD & FDD : Off
IRQ15 (Reserved) : Secondary.