



User's Manual

VIA *KT600* mainboard
for AMD Socket A processor

TRADEMARK

All products and company names are trademarks or registered trademarks of their respective holders.

These specifications are subject to change without notice.

*Manual Revision 1.0
June 18, 2003*

DISCLAIMER OF WARRANTIES:

THERE ARE NO WARRANTIES WHICH EXTEND BEYOND THE DESCRIPTION ON THE FACE OF THE MANUFACTURER LIMITED WARRANTY. THE MANUFACTURER EXPRESSLY EXCLUDES ALL OTHER WARRANTIES, EXPRESS OR IMPLIED, REGARDING ITS PRODUCTS; INCLUDING ANY IMPLIED WARRANTIES OF MERCHANTABILITY, FITNESS FOR A PARTICULAR PURPOSE OR NONINFRINGEMENT. THIS DISCLAIMER OF WARRANTIES SHALL APPLY TO THE EXTENT ALLOWED UNDER LOCAL LAWS IN THE COUNTRY PURCHASED IN WHICH LOCAL LAWS DO NOT ALLOW OR LIMIT THE EXCLUSION OF THE IMPLIED WARRANTIES.

80 Port Frequently Asked Questions

Below is a list of some basic POST Codes, possible problems, and solutions. For more detailed information about POST Codes, refer to Appendix E in this manual.

POST CODE	Problem	Solution
FFh or CFh	<ol style="list-style-type: none">1. BIOS chip inserted incorrectly2. Incorrect BIOS update version3. Mainboard problem4. Add-on card inserted incorrectly.	<ol style="list-style-type: none">1. Reinsert the BIOS chip2. Download the correct BIOS version update from the manufacturer's Web site.3. Replace mainboard4. Remove and replace the add-on card
C1h - C5h	<ol style="list-style-type: none">1. Memory module inserted incorrectly2. Memory compatibility problem3. Memory module damaged	<ol style="list-style-type: none">1. Reinsert memory module2. Replace memory with correct type3. Replace memory module
2Dh	<ol style="list-style-type: none">1. Error occurred in VGA BIOS2. VGA card inserted incorrectly	<ol style="list-style-type: none">1. Replace VGA card2. Reinsert the VGA card
26h	Overclock error	Clear CMOS or press the insert key to power on the system
07h - 12h	<ol style="list-style-type: none">1. Initial Keyboard controller error2. RTC error	<ol style="list-style-type: none">1. Ensure that the keyboard and mouse are connected correctly.2. Replace the RTC battery.

Table of Contents

	<i>Page</i>
Section 1	Introduction
	Package Contents 1-1
	Overview
	Athlon™ Processors 1-2
	Accelerated Graphics Port 1-3
	Ultra ATA66/100/133 1-3
	Hardware Monitoring 1-3
	LAN (Optional) 1-3
	Serial ATA 1-3
	IEEE 1394 (Optional) 1-4
	Mainboard Form-Factor 1-5
	I/O Shield Connector 1-6
	Power-On/Off (Remote) 1-6
	System Block Diagram 1-7
Section 2	Features
	Mainboard Features 2-1
Section 3	Installation
	Mainboard Layout 3-2
	Easy Installation Procedure
	CPU Insertion 3-3
	Jumper Settings 3-5
	System Memory Configuration 3-6
	Expansion Slots 3-8
	Device Connectors 3-10
	STR (Suspend To RAM) Function 3-16
	CPU Overheating Protection 3-17

Section 4	<i>Award BIOS Setup</i>	
	Main Menu	4-1
	Standard CMOS Setup	4-2
	Advanced BIOS Features	4-3
	Advanced Chipset Features	4-7
	Integrated Peripherals	4-12
	Power Management Setup	4-17
	PNP/PCI Configuration Setup	4-21
	PC Health Status	4-23
	Power BIOS Features	4-24
	Defaults Menu	4-26
	Supervisor/User Password Setting	4-27
	Exit Selecting	4-28
Section 5	<i>Driver Installation</i>	
	Easy Driver Installation	5-1
	Realtek Sound Manager Quick User-guide	5-2
Appendix	<i>Appendix A</i>	
	Realtek Media Player User's Guide	A-1
	<i>Appendix B</i>	
	Update Your System BIOS	B-1
	<i>Appendix C</i>	
	EEPROM BIOS Remover	C-1
	<i>Appendix D</i>	
	GHOST 7 Quick User's Guide (Optional)	D-1
	<i>Appendix E</i>	
	POST Codes	E-1

Section 1
INTRODUCTION

Package Contents

Contents

- A. Mainboard
- B. User's manual
- C. Floppy drive cable
- D. HDD ribbon cable
- E. CD and diskette (drivers and utilities)
- F. I/O Shield
- G. Game port cable
- H. S-ATA data and power cables

Deluxe Pack Items

- I. IEEE 1394 two port cable

Other Optional Items

- J. Extra USB2.0 port cable
- K. S/PDIF Module

If you need the other optional item, please contact your dealer for assistance.

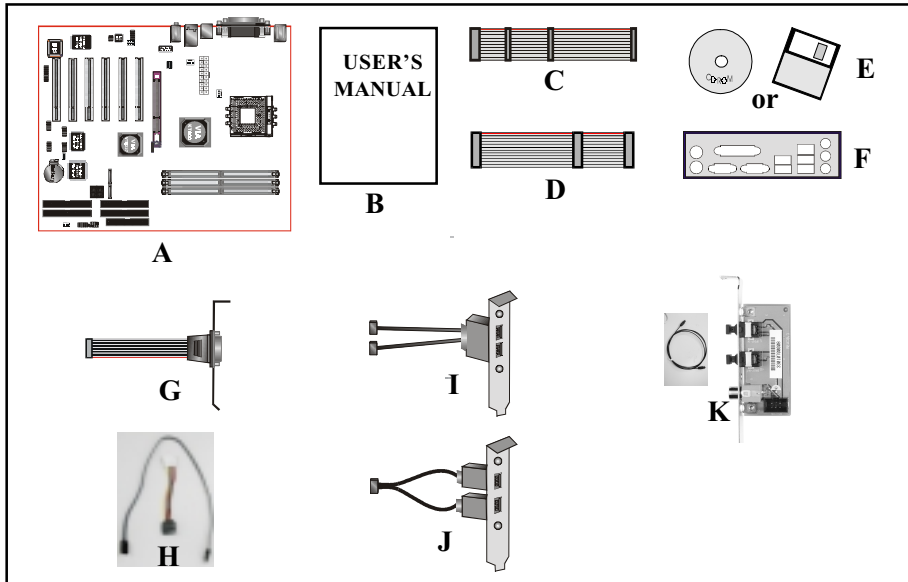

Introduction

Athlon™ Processors

The AMD Athlon™ is a seventh-generation micro architecture with an integrated L2 cache, which is powerful enough to support the bandwidth requirements of a large range of applications, hardware, graphics, and memory technologies. These processors implement advanced design techniques such as:

- ◆ Socket A (PGA 462)
- ◆ 200/266/333/400MHz system interface based on the Alpha™ EV6 bus protocol.
- ◆ Three out-of-order, superscalar, pipelined Multimedia Units.
- ◆ Three out-of-order, superscalar, pipelined Integer Units.
- ◆ Fixed-sized internal instruction formats (MacroOPs).
- ◆ 72-entry Instruction Control Units.
- ◆ AMD enhanced 3DNow!™ technology
- ◆ L1 and L2 caches.
- ◆ Dynamic branch prediction.

Socket A is the name for AMD's new socketed interface designed to support AMD Athlon™ processors. This innovation is made possible by integrating the L2 cache memory on chip with the processor. Socket A will help enable smaller enclosures, and ultimately result in a wider variety of solutions in the market.

The Athlon™ processors in the Socket A format continue to deliver the ultimate performance for cutting-edge applications. They bring to desktop systems running industry-standard x86 software superscalar RISC performance. Being provided in the Socket A format they are the world's most powerful x86 processors. They easily deliver the highest integer, floating-point, and 3D multimedia performance for applications running on x86 platforms around.

It features full-speed, on-chip cache memory, a 200/266/333/400MHz front side system bus, and enhanced 3DNow!™ technology. The AMD Athlon™ processor is targeted at the performance segment, and as such will have more cache memory and higher clock speeds.

Accelerated Graphics Port (AGP)

The AGP slot on the board is compliant with the new AGP 3.0 specification. This new specification enhances the functionality of the original AGP specification by allowing 8X data transfers (8 data samples per clock) resulting in maximum bandwidth of 2.1GB/s. In addition, it defines 1.5 volt power supply operation. Complying with this specification, this board supports external AGP-8X/4X cards with Fast Write Transactions. Only 1.5V AGP cards are supported.

Ultra ATA/66/100/133

This mainboard provides two independent ATA133 IDE controllers, supporting standard programmable input/output (PIO) and Direct Memory Access (DMA) mode operations, as well as UltraDMA-133/100/66/33 standards for a maximum data transfer rate of 133MB/sec per channel.

Hardware Monitoring

Hardware monitoring enables you to monitor various aspects of the system operation and status. The features include CPU temperature, voltage and fan speed in RPMs.

LAN (Optional)

This mainboard is optionally mounted with a LAN chipset. It allows the mainboard to connect to a local area network by means of a network hub.

Serial ATA

The evolutionary serial ATA interface replaces the standard parallel ATA physical storage interface. The serial ATA specification provides scalability and allows future enhancements to the computing platform. Serial technology overcomes performance limits of parallel interface architecture, meeting the escalating need for faster data throughput in servers and storage devices.

Serial ATA is completely software compatible with parallel ATA, requiring no modification to your operating system. The serial ATA interface cable requires lower voltages and uses smaller cable connectors, providing ease of installation. You can easily upgrade storage devices that are compatible with the serial ATA interface specification.

Introduction

IEEE1394 (Optional)

IEEE 1394 is a high-speed serial bus developed by Apple that allows users to connect up to 63 devices to the serial bus on a PC. IEEE is sometimes called the IEEE 1394 standard, the i.Link connector, FireWire, and the High Performance Serial Bus (HPSB).

IEEE 1394 provides transfer rates up to 400Mbits/sec. IEEE 1394 provides enhanced PC connectivity for consumer electronics audio/video (A/V) appliances, storage peripherals, portable devices such as digital cameras, and inter-PC communications. IEEE 1394 supports hot swapping, multiple speeds on the same bus, and isochronous data transfer providing much needed bandwidth for multimedia operations.

Mainboard Form-Factor

This board is designed with ATX form factor - the latest industry standard for chassis design. The ATX form factor is essentially a Baby-AT baseboard rotated 90 degrees within the chassis enclosure and a new mounting configuration for the power supply. With these changes the processor is relocated away from the expansion slots, allowing them all to hold full length add-in cards. ATX defines a double height aperture to the rear of the chassis which can be used to host a wide range of onboard I/O. Only the size and position of this aperture is defined, allowing PC manufacturers to add new I/O features (e.g.; TV input, TV output, joystick, modem, LAN, audio, etc.) to systems. This will help systems integrators differentiate their products in the marketplace, and better meet your needs.

- By integrating more I/O down onto the board and better positioning the hard drive and floppy connectors, material cost of cables and add-in cards are reduced.
- By reducing the number of cables and components in the system, manufacturing time and inventory holding costs are reduced and reliability will increase.
- By using an optimized power supply, it's possible to reduce cooling costs and lower acoustical noise. An ATX power supply, which has a side-mounted fan, allows direct cooling of the processor and add-in cards making a secondary fan or active heatsink unnecessary in most system applications.

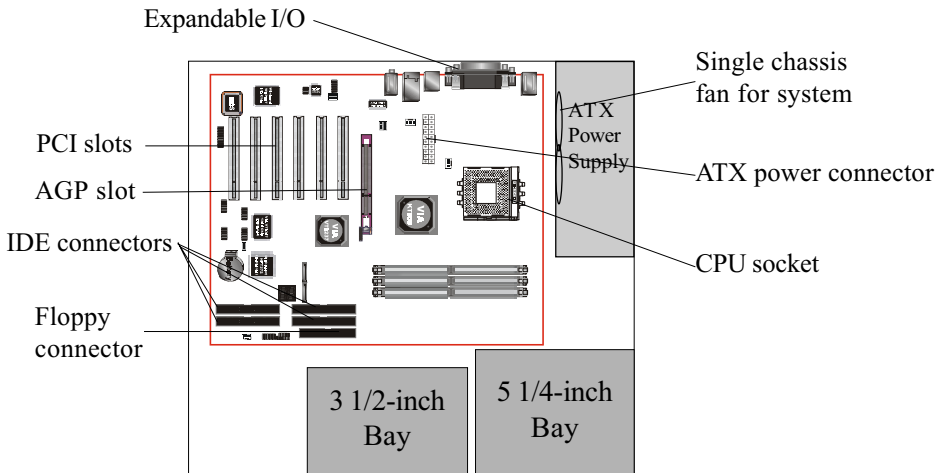

Figure 2: Summary of ATX chassis features

Introduction

I/O Shield Connector

The board is equipped with an I/O back panel (Figure 3). Ensure that your computer case has the appropriate I/O cutout.

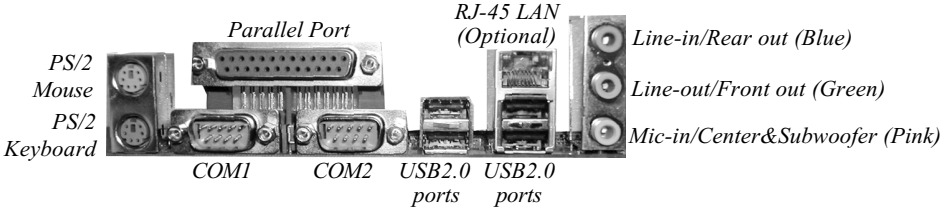

Figure 3: I/O ports

Power-On/Off (Remote)

This board has a 20-pin ATX power supply connector (Figure 4). For power supplies that support the **Remote On/Off** feature, this should be connected to the mainboard front panel PW_ON connector for the computer power On/Off button. This board has been designed with "Soft Off" function. You can turn off the system in two ways: by pressing the front panel power On/Off button or using the "Soft Off" function that can be controlled by an operating system such as Windows®XP/ME/2000/98.

Note: For maintaining the DDR SDRAM power during STR (ACPI S3) function, it is strongly recommended to use power supplies that have a +5VSB current of (> =) 2A. Please check the 5VSB's specification printed on the power supply's outer case.

Note: The board requires a minimum of 250 Watt power supply to operate. Your system configuration (amount of memory, add-in cards, peripherals, etc.) may exceed this minimum power requirement. To ensure that adequate power is provided, use a 300 Watt (or higher) power supply.

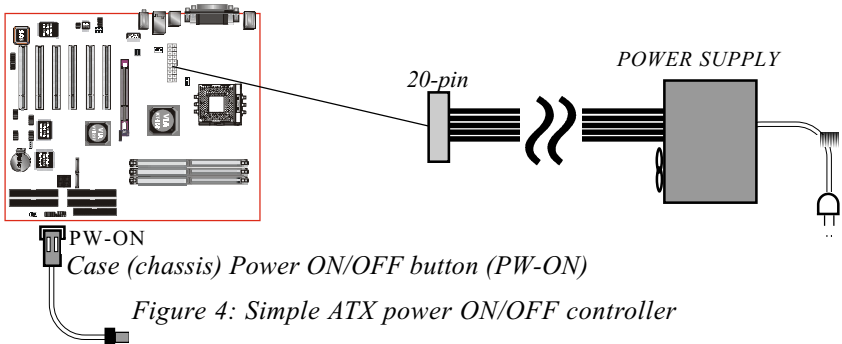

Figure 4: Simple ATX power ON/OFF controller

System Block Diagram

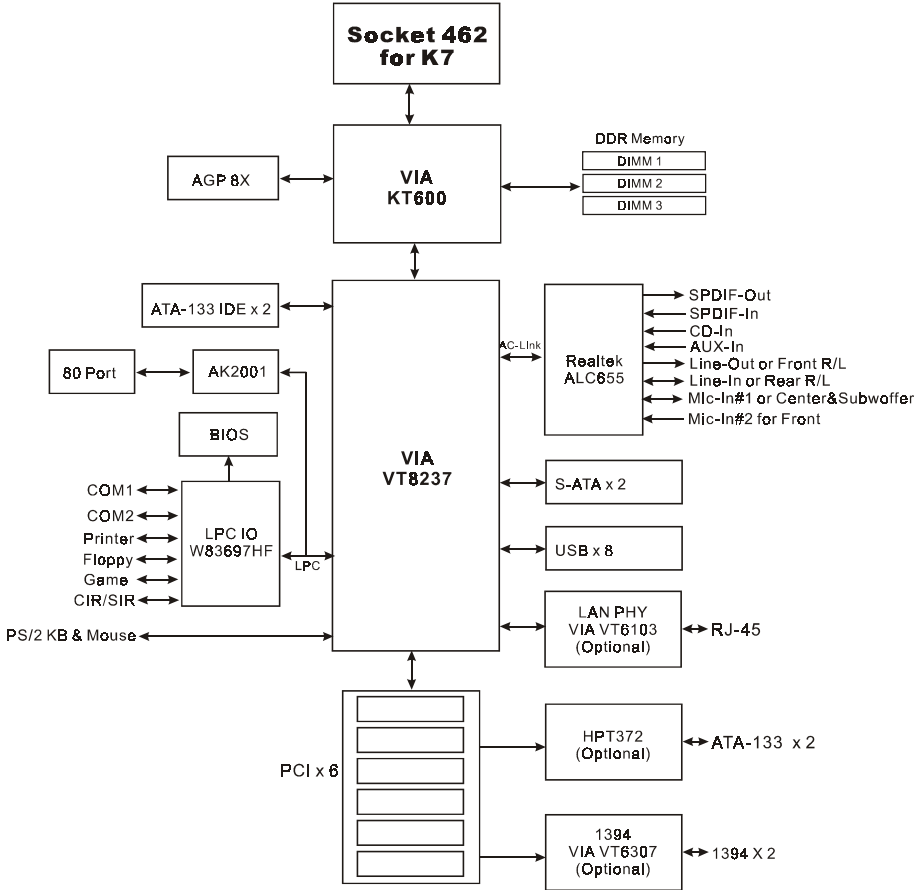

Figure 5: System Block Diagram

Mainboard Features

● **Processor**

- ◆ Supports 462-pin Socket A for AMD Athlon XP processors with 200/266/333/400MHz Front Side Bus
 - Athlon XP (1500+ to 3000+) with 266/333MHz Front Side Bus,
 - Barton (2500+ to 3200+) with 333/400MHz Front Side Bus

● **Chipset**

- ◆ VIA KT600 AGPset: VIA KT600 + VT8237

● **Main Memory**

- ◆ **Three** 184-pin DDR DIMM sockets for 64-bit, Unbuffered, Single/Double-side and Non-ECC DDR-266/333/400 DIMMs
- ◆ Supports up to **3GB** memory size

● **BIOS**

- ◆ Flash EEPROM with Award BIOS
 - ACPI v2.0 compliant
 - S3 (Suspend to DRAM) sleep-state support
 - SMBIOS (System Management BIOS) v2.2 compliant
 - Supports Power failure recovery
 - Able to wake the computer from specific states by LAN, Power switch, PME#, RTC alarm, USB, PS2 KB&Mouse, Modem ring on COM#1...

● **Onboard PCI Devices**

- ◆ LAN --> Embedded 10/100Mbps Fast Ethernet controller with onboard (Optional) **VIA 6103** PHY

Features

- ◆ 1394--> Onboard 1394 controller from [VIA VT6307](#) for 2 port solution (Optional)
 - IEEE-1394a compliant with up to 400Mbps bandwidth
- ◆ IDE--> Embedded IDE controller with 2 ordinary IDE ports up to 4 IDE devices, supports ATA-133 with up to 133MB/sec bandwidth
 - 2 extra IDE Port by HPT372 with Ultra DMA-133 & IDE RAID up to 4 devices (Optional)

● Legacy IO Controller

- ◆ [Winbond W83697HF](#) LPC IO controller for floppy, printer, serial and CIR/SIR interface

● Audio

- ◆ Six channel audio with analog and digital output using [Realtek ALC655](#) AC'97 CODEC
 - AC'97 v2.3 compliant
 - In 2-CH mode, supports Line-In (Blue), Line-Out (Green) and Mic-In (Pink) at rear panel
 - In 6-CH mode, supports Rear speaker out (Blue), Front speaker out (Green) and Center&Subwoofer speaker out (Pink) at rear panel
 - Supports CD-In, Aux-In and S/PDIF-in/out interface
 - Supports Line-out and Mic-In for front panel
 - Supports automatic “jack-sensing”

● Peripheral Interfaces

☞ At Rear Panel

- ◆ PS/2 keyboard and mouse ports
- ◆ [One](#) Parallel (printer) port
- ◆ [Two](#) Serial port
- ◆ [One](#) RJ45 LAN connector (Optional)
- ◆ [Four](#) USB2.0 ports
- ◆ [Three](#) Audio jacks

☞ Onboard connector and pin-header

- ◆ **One** floppy drive connector
- ◆ **Two** IDE connectors
- ◆ **Two** extra IDE connectors with RAID function (Optional)
- ◆ **Four** extra USB2.0 ports
- ◆ **One** CD-IN and One AuX-IN connector
- ◆ **One** S/PDIF in/out connector
- ◆ **One** IR connector
- ◆ **One** Front Panel Audio connector
- ◆ **One** Game port connector
- ◆ **Two** S-ATA connectors
- ◆ **Two** IEEE 1394 connectors
- ◆ **Three** Fan connectors

● **Front Panel Controller**

- ◆ Supports Reset & Soft-Off switches
- ◆ Supports HDD & Power LEDs
- ◆ Supports PC speaker

● **Expansion Slots**

- ◆ **One** AGP slot supporting 1.5v **4X/8X** AGP cards
 - AGP v3.0 compliant
- ◆ **Six** PCI slots with Bus Master support
 - PCI v2.2 compliant

● **Other Features**

- ◆ Magic Health – a BIOS H/W monitoring utility for voltage, temperature and fan-speed sensing displayed during POST
- ◆ EZ Boot – A simple shortcut to select the boot device, e.g. hard drive, CD-ROM or floppy without entering CMOS setup

Features

- ◆ Supports exclusive KBPO (Keyboard Power On) function
- ◆ Excellent Over clocking capabilities through
 - subtle voltage tuning for CPU, Memory
 - subtle frequency tuning on FSB
 - supports complete Asynchronous FSB/Memory for overclocking
- ◆ CPU Overheating Protection

● **Form Factor**

- ◆ 305mm x 244 mm ATX size

Section 3
INSTALLATION

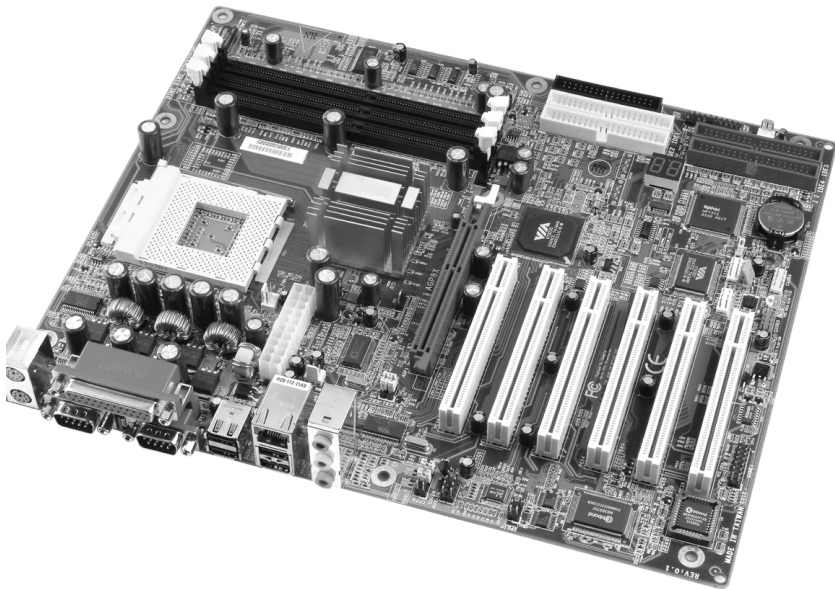

Mainboard Layout

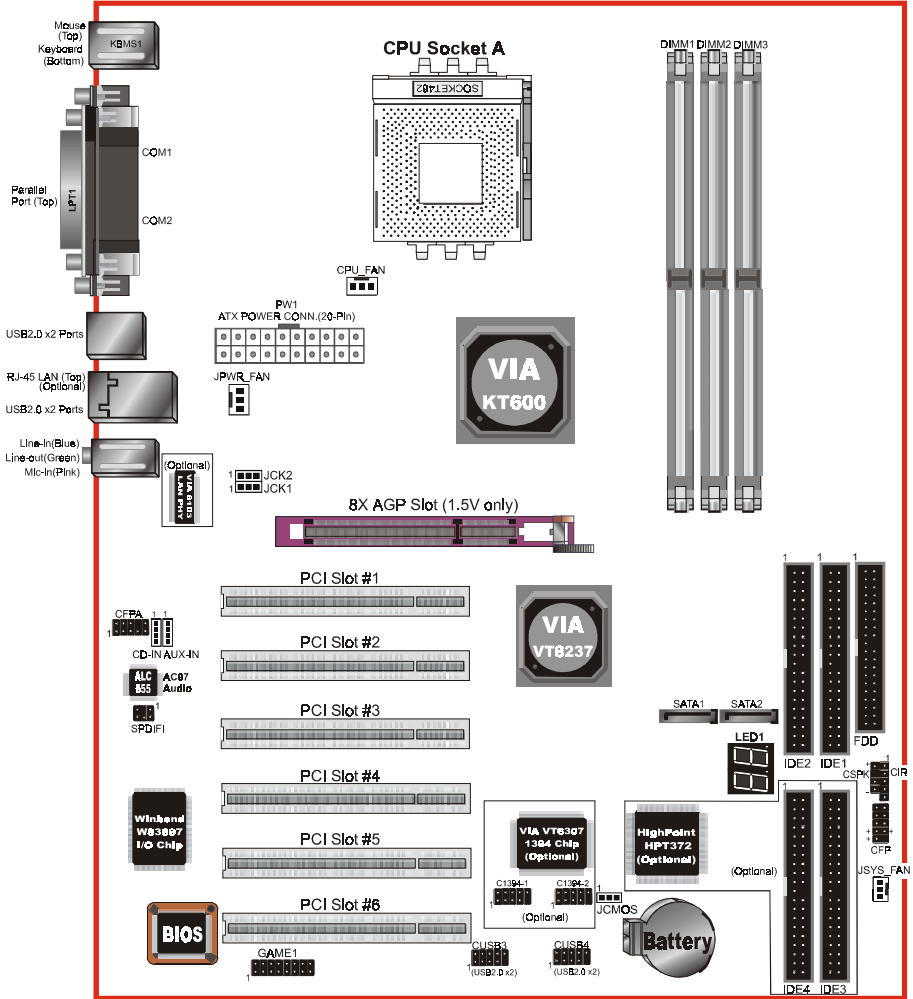

Figure 1

Easy Installation Procedure

The following must be completed before powering on your new system:

- 3-1. CPU Installation
- 3-2. Jumper Settings
- 3-3. System Memory Configuration
- 3-4. Expansion Slots
- 3-5. Device Connectors

3-1 CPU Installation

CPU Insertion: (use AMD Athlon™ as reference)

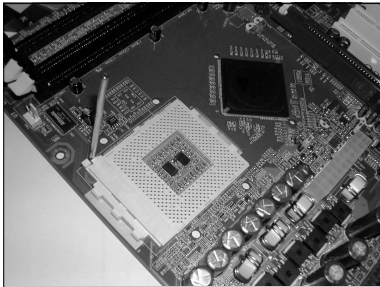

Figure 2

Step 1

Open the socket by raising the actuation lever.

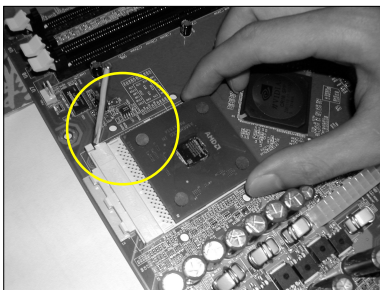

Figure 3

Step 2

Insert the processor.

Ensure proper pin 1 orientation by aligning the FC-PGA corner marking with the socket corner closest to the actuation arm tip. The pin field is keyed to prevent mis-oriented insertion.

Don't force processor into socket. If it does not go in easily, check for mis-orientation and debris.

Make sure the processor is fully inserted into the socket on all sides.

Installation

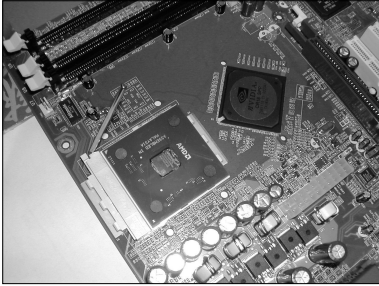

Figure 4

Step 3

Close the socket by lowering and locking the actuation lever.

Step 4

Thermal compound and qualified heatsink recommended by AMD are a must to avoid CPU overheat damage. For more information about installing your CPU, please refer to the AMD website article “Socket A AMD processor and Heatsink Installation Guide” <http://www.amd.com/products/cpg/athlon/pdf/23986.pdf>.

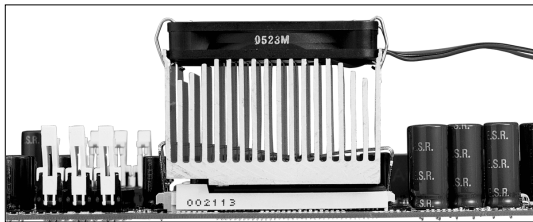
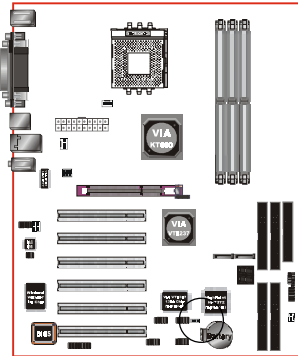

Figure 5

3-2 Jumper Settings



JCMOS: Clear CMOS data Jumper

If the CMOS data becomes corrupted or you forgot the supervisor or user password, clear the CMOS data to reconfigure the system back to the default values stored in the ROM BIOS.



Settings:

- 1-2: Normal (Default)
- 2-3: Clear CMOS

To CMOS Clear data, please follow the steps below.

1. Turn off the system.
2. Change the jumper from “1-2” to “2-3” position for a few seconds.
3. Replace the jumper on to the “1-2” position.
4. Turn on the system and hold down the key to enter BIOS setup.

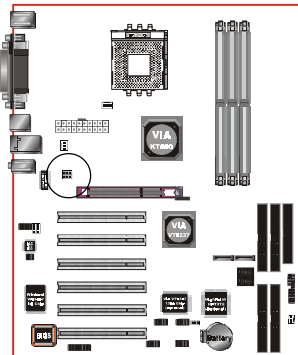

JCK1/ CPU FSB Select Jumper

JCK2: This jumper is used to select the front side bus of the CPU installed on the mainboard.

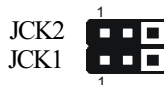

Settings:

- | JCK1 | JCK2 | Settings: |
|------|------|-------------------|
| 1-2 | 1-2 | By BIOS (Default) |
| 2-3 | 1-2 | 133MHz |
| 2-3 | 2-3 | 166MHz |
| 1-2 | 2-3 | 200MHz |

CAUTION!

If you change JCK1 and JCK2 back to default settings, you must use the Clear CMOS function, or else the system will not boot-up.

Note: Overclocking may cause system instability and are not guaranteed to provide better system performance.

Installation

3-3 System Memory Configuration

Memory Layout

The mainboard accommodates three PC2100/PC2700/PC3200 184-pin DIMMs (Dual In-line Memory Modules):

- Supports up to 3.0GB of 266/333MHz DDR SDRAM
- Supports up to 2.0GB of 400MHz DDR SDRAM (see note below)
- Supports unbuffered and non-ECC DIMMs
- Supports configurations defined in the JEDEC DDR DIMM specification

Figure 6 and Table 1 show two possible memory configurations.

<Figure 6>



<Table 1>

Total Memory	DDR DIMM 1	DDR DIMM 2	DDR DIMM 3
= 1GB Maximum	DDR SDRAM* 64MB, 128MB, 256MB, 512MB, 1GB* X 1	None	None
= 2GB Maximum	DDR SDRAM* 64MB, 128MB, 256MB, 512MB, 1GB* X 1	DDR SDRAM* 64MB, 128MB, 256MB, 512MB, 1GB* X 1	None
= 3GB Maximum (except DDR400)	DDR SDRAM* 64MB, 128MB, 256MB, 512MB, 1GB* X 1	DDR SDRAM* 64MB, 128MB, 256MB, 512MB, 1GB* X 1	DDR SDRAM* 64MB, 128MB, 256MB, 512MB, 1GB* X 1

NOTES:

- For DDR400, only up to two slots are guaranteed. Stability and performance with three slots are not guaranteed.
- When FSB is 200MHz, only DDR266 is supported.
- When FSB is 266/333/400MHz, DDR266/333/400 are supported.
- Using non-compliant memory with higher bus speeds (overclocking) may severely compromise the integrity of the system.

DIMM Module Installation

Figure 7 displays the notch on the DDR DIMM memory module.

DIMMs have 184 pins and one notch that matches with the DDR DIMM socket. DIMM modules are installed by placing the chip firmly into the socket and pressing straight down as shown in figure 8 until the white clips close and the module fits tightly into the DIMM socket (figure 9).

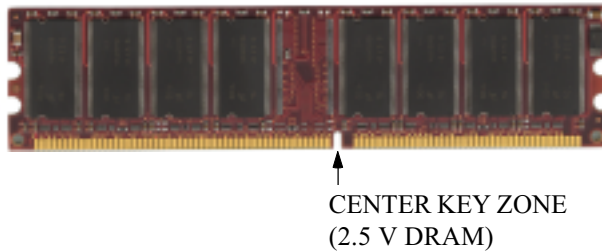

Figure 7 - DIMM notch

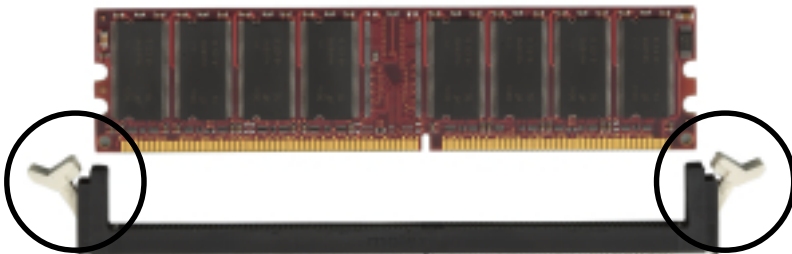

Figure 8 - DIMM module clips before installation

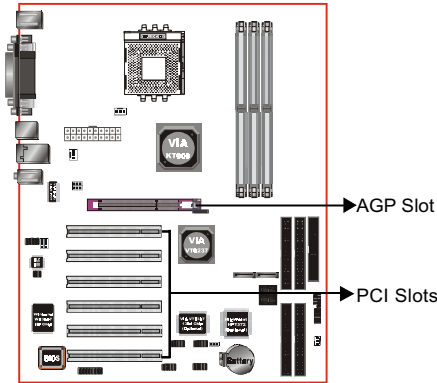

Figure 9 - DIMM module clip after installation

To remove the DIMM module press down the white clips and the module is ejected from the socket.

Installation

3-4 Expansion Slots



AGP Slot

The mainboard is equipped with an AGP slot. Make sure you install a card that supports the 1.5V specification.

PCI Slots

The mainboard is equipped with 6 PCI slots.

Installing an Expansion Card

The steps below assume that the mainboard is already installed in the system chassis.

1. Make sure the PC and all other peripheral devices connected to its has been powered down.
2. Disconnect all power cords and cables.
3. Remove the system unit cover.
4. Remove the bracket of the slot that you intend to use. (You need to remove the screw in order to remove the bracket.)
5. Align the card above the slot then press it down firmly until it is completely seated in the slot.
6. Secure the card to the chassis with the screw you removed in step 4.
7. Replace the system unit cover.
8. Power on the PC.
9. Enter the BIOS step program to make the necessary settings.
10. Save the settings and restart the PC.
11. Install the software drivers of the expansion cards, if necessary.

AGP Card Installation Caution

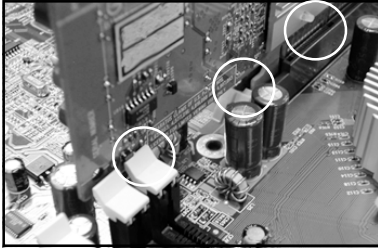

1. AGP card component is blocked by DIMM socket lock.
2. AGP slot clicker is not locked.
3. AGP card edge connector is not inserted properly.

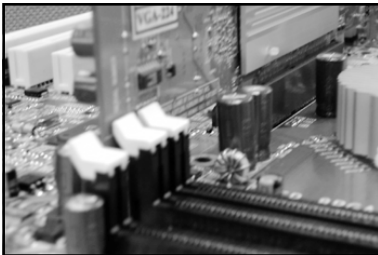

1. AGP card component is not blocked by DIMM socket lock.
2. AGP slot clicker is locked.
3. AGP card edge connector is inserted properly.

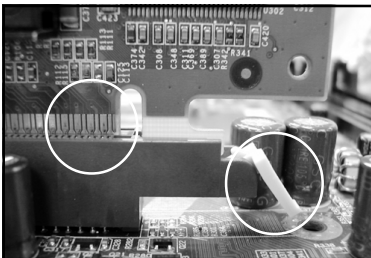

1. AGP slot clicker is not locked.
2. AGP card edge connector is not inserted properly.

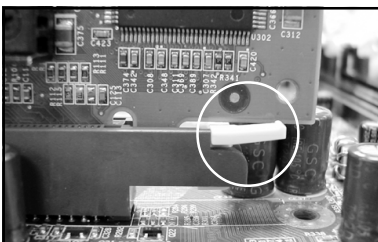

1. AGP slot clicker is locked.
2. AGP card edge connector is inserted properly.



Installation

3-5 Device Connectors

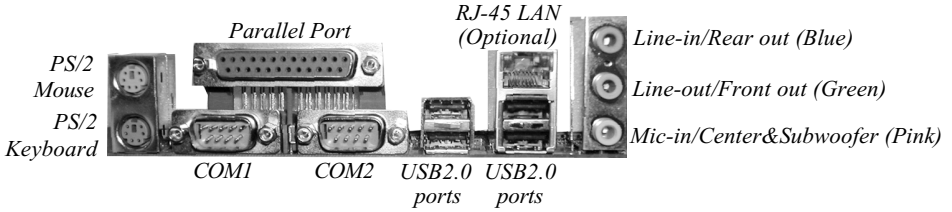
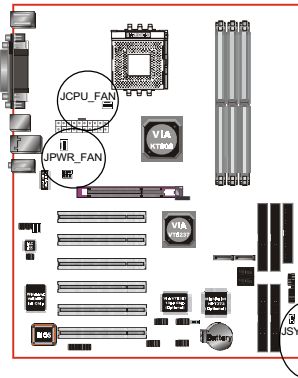

Figure 10 - I/O Ports



JCPU_FAN / JPWR_FAN / JSYS_FAN:

CPU/Chassis Fan Power Connectors

JCPU_FAN: The CPU must be kept cool by using a heatsink with fan assembly.

JPWR_FAN: If you are installing an additional fan in the unit, connect to this fan connector.

JSYS_FAN: The chassis fan will provide adequate airflow throughout the chassis to prevent overheating the CPU.

JCPU_FAN

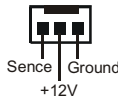

JPWR_FAN



JSYS_FAN

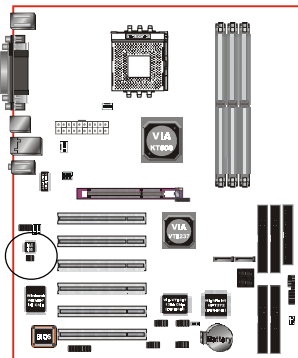
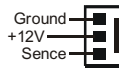

S/PDIFI: Sony/Philips Digital InterFace connector

This connector links digital audio between the mainboard and your audio devices, such as CD player, sampler or DAT recorder. It allows the digital transmission of audio data in S/PDIF format.

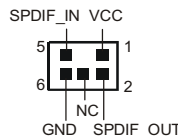

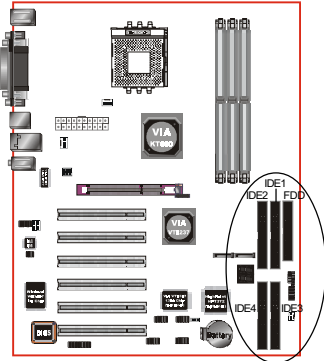

FDD1: Floppy drive Connector

This mainboard is equipped with a floppy disk drive connector for connecting up to 2 floppy disk drives.

IDE1/IDE2: Ultra DMA-66/100/133 Primary/Secondary IDE Connector

This mainboard is equipped with 2 IDE disk connectors for connecting up to 4 ATA-133 IDE drives. It supports PIO and DMA mode operations for maximum data transfer rate of 133MB/sec per channel.

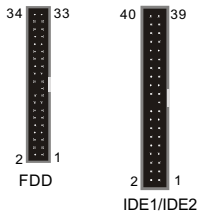

IDE3/IDE4: Ultra DMA-133 & RAID IDE Connector **(Optional)** Supported by HPT372 chipset, refer to HPT372 RAID Controller user's manual for detail information.

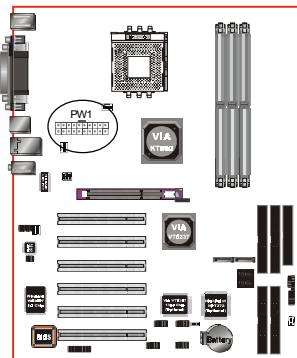

PW1: 20-pin ATX Power Connector

The mainboard is equipped with a standard 20-pin ATX main power connector for connecting power supply. The plugs of the power cables are designed to fit in only one orientation. Find the proper orientation then insert the plugs into the connectors until they fit in place.

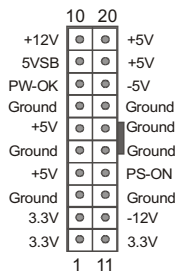

Installation

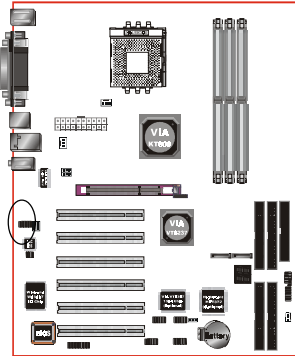

CFPA: Front Panel Audio Connector

When the jumpers are removed this connector can be used for front panel audio.

The front panel line-out phone jack should have a “normal close” switch. Without a phone-plug inserted, the rear panel audio is enabled. With phone plug inserted, the rear panel audio will be disabled.

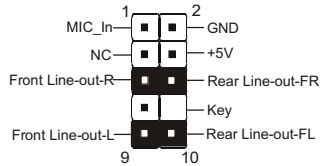

Settings

Pins (5-6) & (9-10) Short (default): Only the onboard rear panel audio jack can be used.

Pins (5-6) & (9-10) Open: Only front panel audio jack can be used.



In 2-Channel audio mode, Mic-In is shared for both front panel and rear panel. In 6-Channel audio mode, the Mic-In is dedicated for front panel use, and rear panel Mic-In function will switch to Center and Subwoofer support.

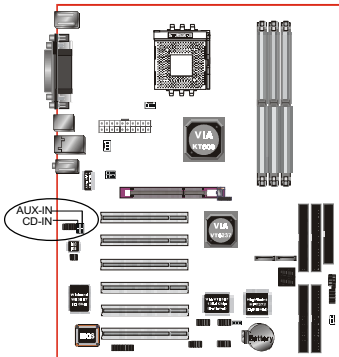

CD-IN/AUX-IN: CD Audio_IN Connector

The CD-IN and AUX-IN connectors are used to receive audio from a CD-ROM drive, TV tuner or MPEG card.

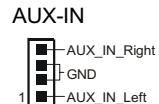
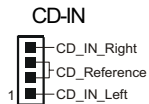

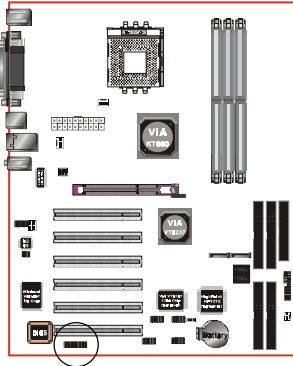

GAME1: Game/MIDI connector

This port works well with any application that is compatible with the standard PC joystick.

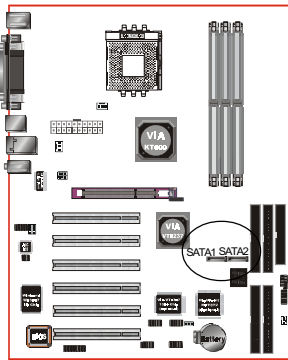

SATA1 / SATA2: Serial ATA Connectors

These connectors enable you to connect two Serial ATA devices that conform to the Serial ATA specification.

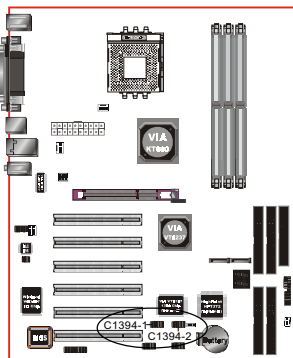
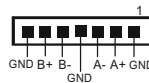

C1394-1 / C1394-2: (Optional)

400Mbps 1394a (FireWire) Connectors

C1394-1 and C1394-2 enable you to connect two IEEE 1394 ports for use with external devices that conform to the IEEE 1394 specification.

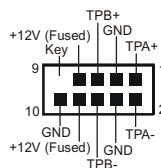

Installation

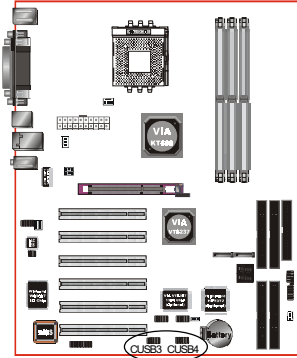

CUSB3/CUSB4: Four USB 2.0 ports

This mainboard includes 4 additional onboard USB ports, identified by 2 10-pin connector.

If you wish to use the additional USB ports, install the card-edge bracket to the system chassis then insert its cables to this 10-pin connector.

USB2.0 allows data transfer speed up to 480Mbps.

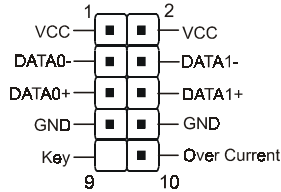

CAUTION!

Please make sure the USB cable has the same pin assignment. A different pin assignment may cause damage to the system.
If you need the USB cable, please contact our retailer.

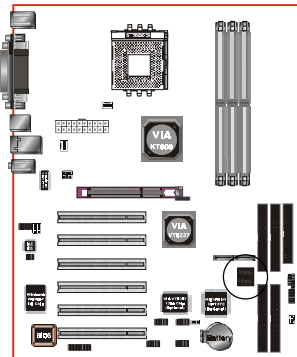

LED1: 80 Port Debug LED

Provides two-digit POST code to show why the system fail to boot. Allows quick and easy optimization.



80 Port Debug 7-segment LED display
(Refer to Appendix E for POST codes)

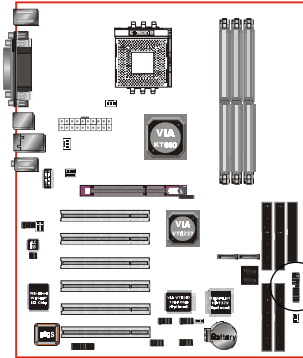

CFP / CIR / CSPK

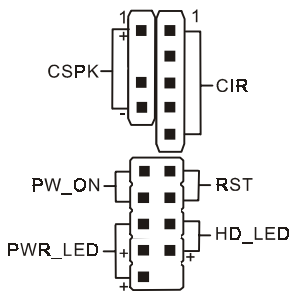

CFP: Front Panel Connector

◆ HD_LED

This LED will light up whenever the hard drive is being accessed.

◆ PWR_LED

This connects to the power button of the system chassis

◆ RST

This switch allows you to reboot without having to power off the system thus prolonging the life of the power supply or system.

◆ PW_ON

This is connected to the power button on the case. Using the Soft-Off by Pwr-BTTN feature, you can choose either Instant Off (turn off system immediately) or 4 sec delay (push the button for 4 seconds to turn off the system). When the system is in 4 sec delay mode, suspend mode is enabled by pushing the button momentarily.

CIR: IR connector

Connect your IrDA cable to the IR connector.

- | | |
|----------|---------|
| 1. VCC | 4. GND |
| 2. CIRRX | 5. IRTX |
| 3. IRRX | |

CSPK: Speaker

Connect to the system's speaker for beeping

- | | |
|--------|------------|
| 1. VCC | 3. GND |
| 2. NC | 4. Speaker |

Installation

3-6 STR (Suspend To RAM) Function

This mainboard supports the STR (Suspend To RAM) power management scheme by maintaining the appropriate power states in the DDR SDRAM interface signals. The power source to the DDR SDRAM is kept active during STR (ACPI S3). Advanced Configuration Power Interface (ACPI) provides many Energy Saving Features for operating systems that support Instant ON and QuickStart™ function.

1. To enable STR functionality to save system power :
 - a. Install ACPI certified add-on cards (such as AGP, LAN, and modem cards).
 - b. In BIOS, under Power Management Setup (refer to Section 4), select “ACPI Suspend Type: S3(STR)” and “USB Port Wake Up Control” (if you have a USB mouse or keyboard device).
 - c. Install Windows® XP/2000/ME/98SE.
 - d. Restart the system.
 - e. Open the Control Panel Power Management application, and click the Advanced tab. In the Power buttons section, select “Stand By” from the drop-down lists.
2. To activate the STR function, click the START button and choose Shut Down. In the Shut Down Windows dialog box, select the Stand By option to enter STR mode.

The following are the differences between STR power saving mode and Green (or Suspend) mode:

- a. STR is the most advanced Power Management mode.
- b. STR cuts all the power supplied to peripherals except to memory - max. power saving.
- c. STR saves and keeps all on-screen data including any executed applications to DDR SDRAM.
- d. In STR mode, you must push the power button (connected to the onboard PW-On of CFP pin), click your USB mouse buttons, or press your USB keyboard keys to wake up your system to the last display.

3-7 CPU Overheating Protection

This mainboard is equipped with CPU Overheating Protection. It will automatically remove power to shutdown the system when CPU temperature reaches approximately 110°C. This is to prevent long term damage to the CPU from overheating. When this happens, the speaker produces a sustained beep sound and the system will not be able to power on. This protection is designed through hardware and no BIOS setup is required.

To power on your system again,

- Step 1:** Unplug the ATX power cord (or turn off the ATX power supply switch)
- Step 2:** Wait a few minutes for the CPU to cool.
- Step 3:** Check that the CPU heatsink and cooling fan assembly is properly installed. **Be careful when touching the heatsink as it may be hot.**
- Step 4:** Plug back the ATX power cord (or turn on the ATX power supply switch) and power -on the system.

If the beeping sound persists, repeat Step 1 to remove the power source.

Note: The CPU Overheating Protection will function only if the CPU is designed with an internal thermal diode. AMD Athlon XP or later CPUs is equipped with internal thermal diode.

Section 4

BIOS SETUP

Main Menu

The ROM BIOS provides a built-in Setup program which allows user to modify the basic system configuration and hardware parameters. The modified data is stored in a battery-backed CMOS, so that data will be retained even when the power is turned off. In general, the information saved in the CMOS RAM will stay unchanged unless there is a configuration change in the system, such as hard drive replacement or a device is added.

It is possible for the CMOS battery to fail causing CMOS data loss. If this happens you will need install a new CMOS battery and reconfigure your BIOS settings.

 The BIOS setup screen and description are for reference only, and may not exactly match what you see on your screen. The contents of BIOS are subject to change without notice. Please visit our website for updates.

To enter the Setup Program :

Power on the computer and press the key during the POST (Power On Self Test). The BIOS CMOS SETUP UTILITY opens.

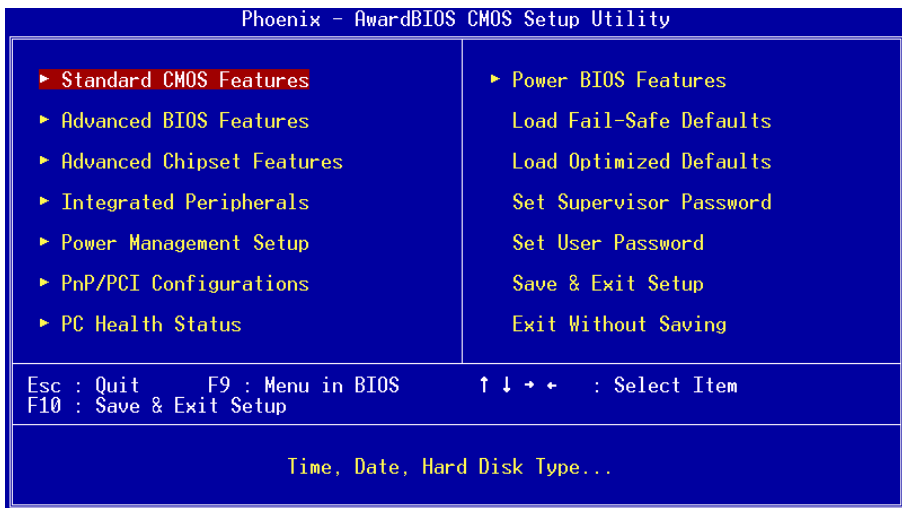

Figure 1: CMOS Setup Utility

BIOS

The main menu displays all the major selection items. Select the item you need to reconfigure. The selection is made by moving the cursor (press any direction (arrow key)) to the item and pressing the 'Enter' key. An on-line help message is displayed at the bottom of the screen as the cursor is moved to various items which provides a better understanding of each function. When a selection is made, the menu of the selected item will appear so that the user can modify associated configuration parameters.

4-1 Standard CMOS Setup

Choose "STANDARD CMOS FEATURES" in the CMOS SETUP UTILITY Menu (Figure 2). Standard CMOS Features Setup allows the user to configure system settings such as the current date and time, type of hard disk drive installed, floppy drive type, and display type. Memory size is auto-detected by the BIOS and displayed for your reference. When a field is highlighted (use direction keys to move the cursor and the <Enter> key to select), the entries in the field can be changed by pressing the <PgDn> or the <PgUp> key.

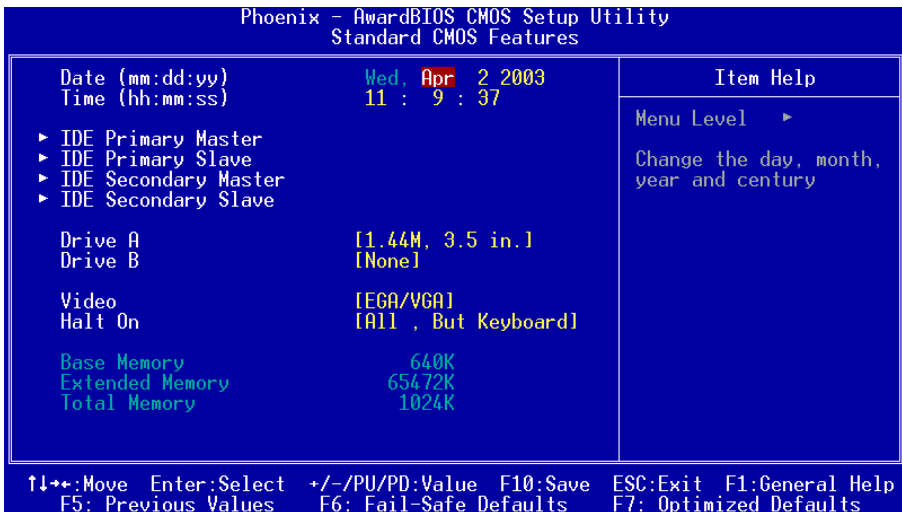

Figure 2: Standard CMOS Setup

Notes:

- If the hard disk Primary Master/Slave and Secondary Master/Slave are set to Auto, the hard disk size and model will be auto-detected.
- The “Halt On:” field is used to determine when the BIOS will halt the system if an error occurs.
- Floppy 3 Mode support is a mode used to support a special 3.5-inch drive used in Japan. This is a 3.5-inch disk that stores 1.2 MB. The default setting for this is disabled.

4-2 Advanced BIOS Features

Selecting the “ADVANCED BIOS FEATURES” option in the CMOS SETUP UTILITY menu allows users to change system related parameters in the displayed menu. This menu shows all of the manufacturer’s default values for the board.

Pressing the [F1] key displays a help message for the selected item.

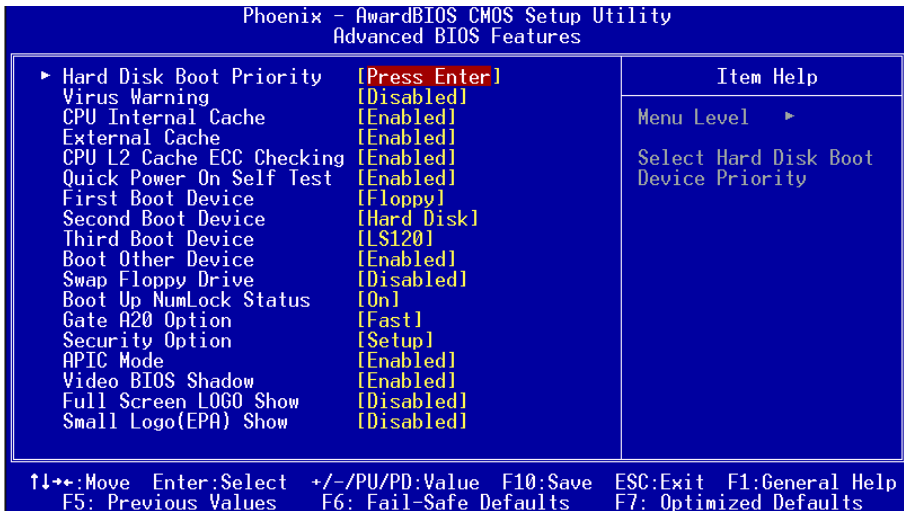
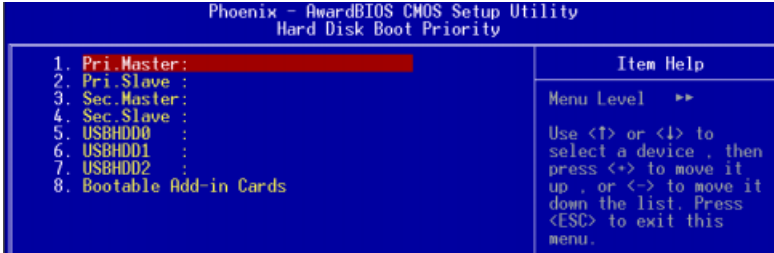

Figure 3: BIOS Features Setup

BIOS

Hard Disk Boot Priority

This item allows you to select the hard disk boot priority.



Virus Warning

During and after system boot up, any attempt to write to the boot sector or partition table of the hard disk drive halts the system and an error message appears.

You should then run an anti-virus program to locate the virus. Keep in mind that this feature protects only the boot sector, not the entire hard drive. The default is Disabled.

Enabled: Activates automatically when the system boots up causing a warning message to appear when anything attempts to access the boot sector.

Disabled: No warning message appears when anything attempts to access the boot sector.

Note: Many disk diagnostic programs that access the boot sector table can trigger the virus warning message. If you plan to run such a program, we recommend that you first disable the virus warning.

CPU Internal Cache

This controls the status of the processor's internal cache area. The default is Enabled.

Options: Enabled, Disabled.

External Cache

This controls the status of the external (L2) cache area. The default is Enabled.

Options: Enabled, Disabled.

CPU L2 Cache ECC Checking

This item allows you to enable/disable CPU L2 Cache ECC checking.

Options: Enabled, Disabled.

Quick Power On Self Test

This category speeds up the Power On Self Test (POST). The default is Enabled.

Enabled: This setting will shorten or skip of the items checked during POST.

Disabled: Normal POST.

First /Second/Third/Other Boot Device

The BIOS attempts to load the operating system from the devices in the sequence selected in these items.

Options: Floppy, LS120, CDROM, ZIP100, USB-FDD, USB-ZIP, USB-CDROM, LAN, Disabled.

Boot Other Device

When enabled, the system searches all other possible locations for an operating system if it fails to find one in the devices specified under the first, second, and third boot devices. The default is Enabled.

Options: Enabled, Disabled.

Swap Floppy Drive

This will swap your physical drive letters A & B if you are using two floppy disks.

Options: Enabled, Disabled.

Boot Up NumLock Status

This controls the state of the NumLock key when the system boots. The default is On.

On: The keypad acts as a 10-key pad.

Off: The keypad acts like cursor keys.

Gate A20 Option

This refers to the way the system addresses memory above 1 MB (extended memory).

Normal: The A20 signal is controlled by the keyboard controller or chipset hardware.

Fast: The A20 signal is controlled by Port 92 or chipset specific method.

Security Option

This category allows you to limit access to the System and Setup, or just to Setup.

System: The system will not boot and the access to Setup will be denied if the correct password is not entered at the prompt.

Setup: The system will boot; but the access to Setup will be denied if the incorrect password is not entered at the prompt.

BIOS

APIC Mode

This item allows you to enable APIC (Advanced Programmable Interrupt Controller) functionality. APIC is an Intel chip that provides symmetric multiprocessing (SMP) for its Pentium systems. The default is Disabled.

Options: Enabled, Disabled.

Video BIOS Shadow

This option allows video BIOS to be copied into RAM. Video Shadowing will increase the video performance of your system.

Options: Enabled, Disabled.

Full Screen LOGO Show

This item allows you determine Full Screen LOGO display during POST.

Options: Enabled, Disabled.

Small Logo (EPA) Show

If the BIOS contains an internal bitmap picture, this option sets the bitmap display at the top right corner of the screen.

Options: Enabled, Disabled.

4-3 Advanced Chipset Features

Choose the “ADVANCED CHIPSET FEATURES” option in the CMOS SETUP UTILITY menu to display following menu.

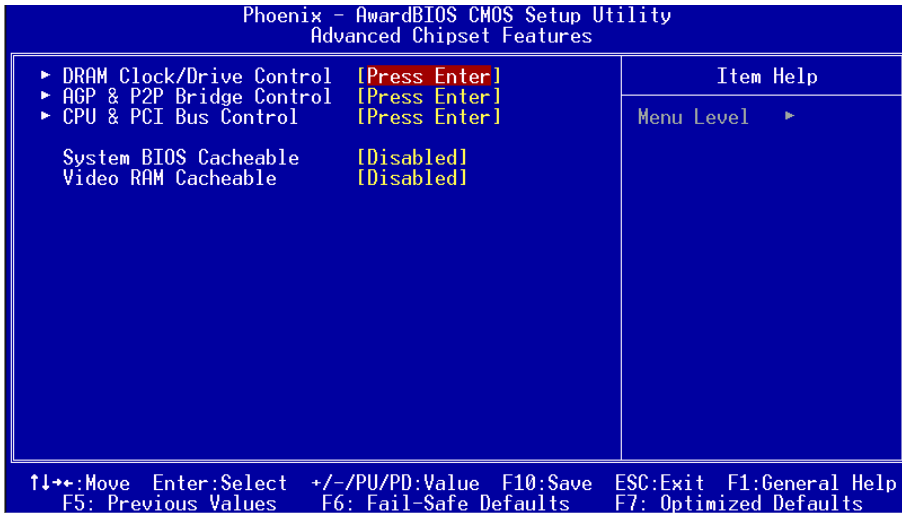

Figure 4: Chipset Features Setup

System BIOS Cacheable

This item allows the system to be cached in memory for faster execution. The default is Enabled.

Options: Disabled, Enabled.

Video RAM Cacheable

This option allows the CPU to cache read/writes of the video RAM. The default is Enabled.

Options: Disabled, Enabled.

BIOS

► DRAM Clock / Drive Control

Scroll to DRAM Clock/Drive Control and press <Enter>. The following screen appears:

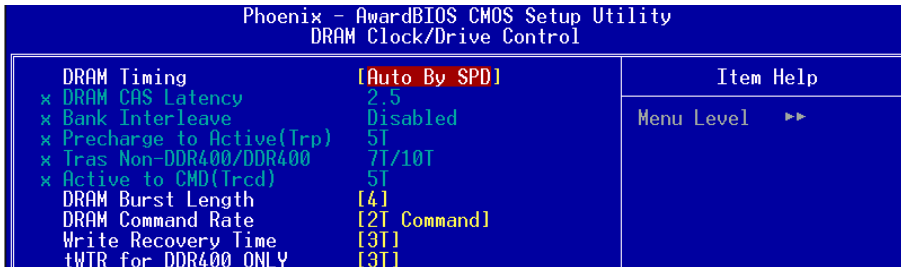

DRAM Timing

For setting DRAM Timing select By SPD to follow SDRAM Serial Presence Detect Specification.

Options: Manual, Auto by SPD, Turbo, Ultra.

DRAM CAS Latency

Enables you to select the CAS latency time. The value is set at the factory depending on the DRAM installed. Do not change the values in this field unless you change specifications of the installed DRAM and DRAM clock from DRAM Timing Selectable. The default is set by SPD (see 'DRAM Timing').

Options: 1.5, 2, 2.5, 3.

Bank Interleave

The item allows you to set how many banks of SDRAM support in your mainboard. Default is by SPD.

Options: 2 Bank, 4 Bank, Disabled.

Precharge to Active (Trp)

This item refers to the number of cycles required to return data to its original location to close the bank or the number of cycles required to page memory before the next bank activate command can be issued. The default is by DRAM SPD.

Options: 3T, 2T, 4T, 5T.

Tras Non-DDR400/DDR400

This item sets tRAS Non-DDR400/DDR400 timing. The default is by DRAM SPD.

Options: 6T/8T, 7T/10T, 5T/6T, 8T/12T.

Active to CMD (Trcd)

This item sets the timing parameters for the system memory such as the CAS (Column Address Strobe) and RAS (Row Address Strobe). The default is by DRAM SPD.

Options: 3T, 2T, 4T, 5T.

DRAM Burst Length

This item sets the DRAM Burst Length.

Options: 4, 8.

DRAM Command Rate

Setup the timing at each cycle.

Options: 1T Command, 2T Command.

Write Recovery Time

This item sets the DRAM Write Recovery Time.

Options: 2T , 3T.

tWTR for DDR400 ONLY

tWTR Timing Control for DDR400 only.

Options: 1T , 3T, 2T.

► AGP & P2P Bridge Control

Scroll to AGP & P2P Bridge Control and press <Enter>. The following screen appears:

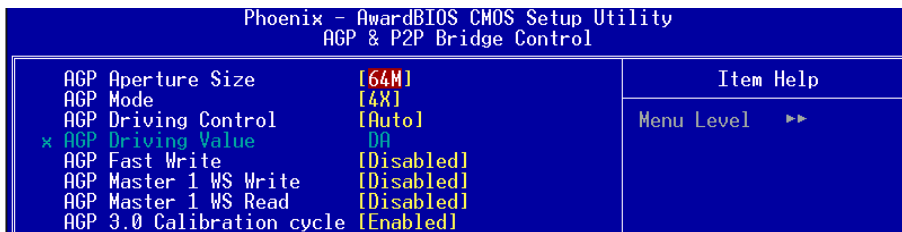

AGP Aperture Size (MB)

This item defines the size of the aperture if you use an AGP graphics adapter. It refers to a section of the PCI memory address range used for graphics memory.

Options: 4M, 8M, 16M, 32M, 64M, 128M, 256M, 512 M, 1G.

BIOS

AGP Mode

Chipset AGP Mode support.

Options: 1X, 2X, 4X.

AGP Driving Control

This item allows you to adjust the AGP driving force. Choose “Manual” to key in a AGP Driving Value in the next selection. This field is recommended to set in “Auto” for avoiding any error in your system.

Options: Auto, Manual.

AGP Fast Write

Selecting Enabled allows to use Fast Write Protocol for 4X AGP card.

Options: Enabled, Disabled.

AGP Master 1 WS Write

When Enabled, Writes to the AGP (Accelerated Graphics Port) are executed with one wait states.

Options: Enabled, Disabled.

AGP Master 1 WS Read

When Enabled, Reads to the AGP (Accelerated Graphics Port) are executed with one wait states.

Options: Enabled, Disabled.

AGP 3.0 Calibration cycle

This item allows you to select AGP 3.0 Calibration cycle function.

Options: Enabled, Disabled.

► **CPU & PCI Bus Control**

Scroll to CPU & PCI Bus Control and press <Enter>. The following screen appears:

Phoenix - AwardBIOS CMOS Setup Utility		CPU & PCI Bus Control	
PCI1 Master 0 WS Write	[Enabled]	Item Help	
PCI2 Master 0 WS Write	[Enabled]	Menu Level	▶▶
PCI1 Post Write	[Enabled]		
PCI2 Post Write	[Enabled]		
VLink 8X Support	[Enabled]		
PCI Delay Transaction	[Enabled]		

PCI1/2 Master 0 WS Write

When Enabled, Writes to the PCI bus are commanded with zero wait states.

Options: Enabled, Disabled.

PCI1/2 Post Write

Enables CPU to PCI bus POST write.

Options: Enabled, Disabled.

VLink 8X Support

Enables VLink 8X support.

Options: Enabled, Disabled.

PCI Delay Transaction

The chipset has an embedded 32-bit posted write buffer to support delay transactions cycles. Select Enabled to support compliance with PCI specification version 2.2.

Options: Enabled, Disabled.

4-4 Integrated Peripherals

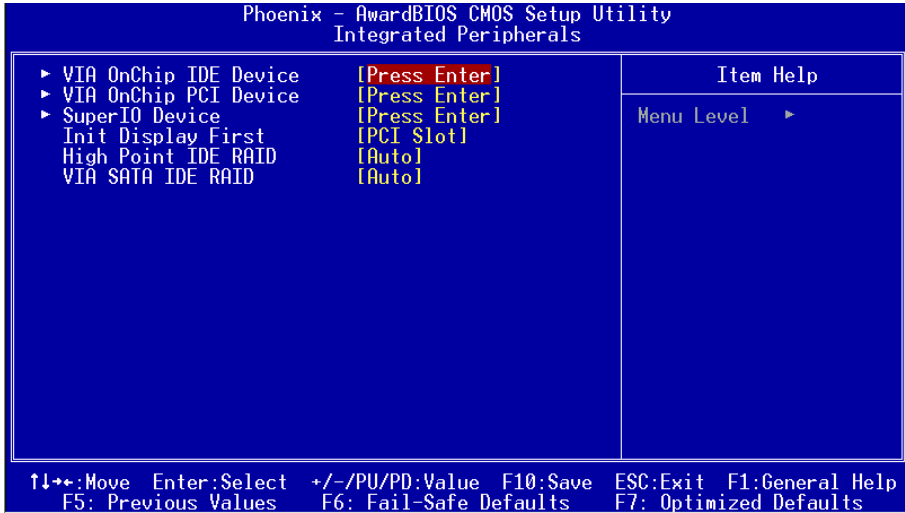

Figure 5: Integrated Peripherals

Init Display First

If two video cards are used (1 AGP and 1 PCI) this specifies which one will be the primary display adapter. The default is PCI Slot.

Options: PCI Slot, AGP.

High Point IDE RAID (Optional)

Enables the onboard HighPoint RAID feature.

Options: Enabled, Disabled, Auto.

VIA SATA IDE RAID (Optional)

Enables the onboard Serial ATA feature.

Options: Enabled, Disabled, Auto.

► **VIA OnChip IDE Device**

Scroll to VIA Onchip IDE Device and press <Enter>. The following screen appears:

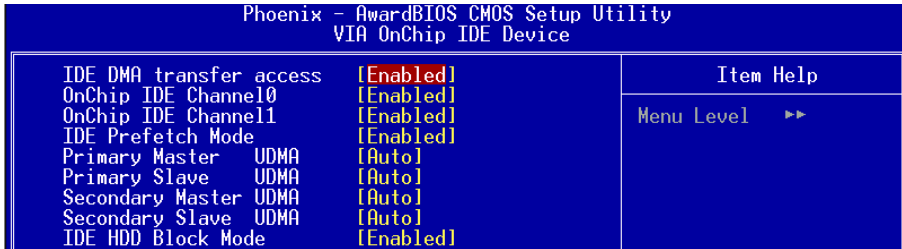

IDE DMA transfer access

Automatic data transfer between system memory and IDE device with minimum CPU intervention. This improves data throughput and frees CPU to perform other tasks. Options: Enabled, Disabled.

OnChip IDE Channel0/1

The integrated peripheral controller contains an IDE interface with support for two IDE channels. Select “Enabled” to activate each channel separately. Options: Enabled, Disabled.

Note: If you do not use the onboard IDE connector, then you will need to set the Onboard Primary PCI IDE and Onboard Secondary PCI IDE to “Disabled”.

IDE Prefetch Mode

Selecting Enabled reduces latency between each drive read/write cycle, but may cause instability in IDE subsystems that cannot support such fast performance. If you are getting disk drive errors, try setting this value to Disabled. This field does not appear when the Internal PCI/IDE field, above, is Disabled. Options: Enabled, Disabled.

Primary/Secondary Master/Slave PIO

The four IDE PIO (Programmed Input/Output) fields let you set a PIO mode (0-4) for each of the four IDE devices that the onboard IDE interface supports. Modes 0 to 4 provide successively increased performance. In Auto mode, the system automatically determines the best mode for each device. Options: Auto, Mode 0 ~ 4.

BIOS

Primary/Secondary Master/Slave UDMA

This allows you to select the mode of operation for the IDE drive. Ultra DMA-33/66/100/133 implementation is possible only if your IDE hard drive supports it and the operating environment includes a DMA driver. If your hard drive and your system software both support Ultra DMA-33/66/100/133, select Auto to enable UDMA mode by BIOS or you can manually disable it.

Options: Auto, Disabled.

IDE HDD Block Mode

Block mode is also called block transfer, multiple commands, or multiple sector read/write. If your IDE hard drive supports block mode (most new drives do), select Enabled for automatic detection of the optimal number of block read/writes per sector the drive can support.

Options: Enabled, Disabled.

▶ VIA Onchip PCI Device

Scroll to VIA Onchip PCI Device and press <Enter>. The following screen appears:

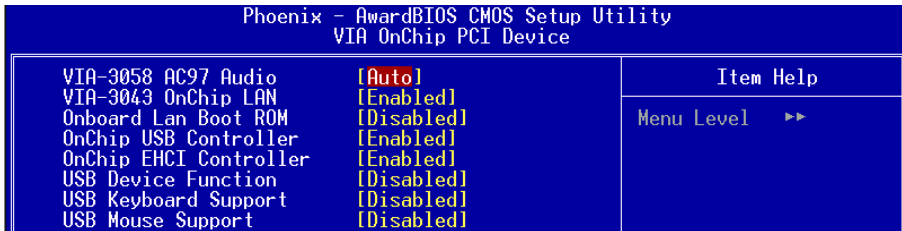

The screenshot shows the BIOS setup utility with the following menu items:

Phoenix - AwardBIOS CMOS Setup Utility	
VIA OnChip PCI Device	
VIA-3058 AC97 Audio	[Auto]
VIA-3043 OnChip LAN	[Enabled]
Onboard Lan Boot ROM	[Disabled]
OnChip USB Controller	[Enabled]
OnChip EHCI Controller	[Enabled]
USB Device Function	[Disabled]
USB Keyboard Support	[Disabled]
USB Mouse Support	[Disabled]

On the right side of the screen, there is a help menu with the following options:

Item Help
Menu Level ▶▶

VIA-3058 AC97 Audio

This item allows you to disable the chipset on-chip support for AC97 Audio.

Options: Auto, Disabled.

VIA-3043 Onchip LAN (Optional)

Enables the onboard LAN feature. The default is Enabled.

Options: Enabled, Disabled.

Onboard Lan Boot ROM (Optional)

Enable/disable the onboard LAN Boot ROM. The default is Disabled.

Options: Enabled, Disabled.

Onchip USB Controller

Enables the USB controller.
Options: Enabled, Disabled.

Onchip EHCI Controller

Enables the EHCI (USB2.0) controller.
Options: Enabled, Disabled.

USB Device Support

Enable/disable support for USB device.
Options: Enabled, Disabled.

USB Keyboard Support

Enable/disable support for USB keyboard.
Options: Enabled, Disabled.

USB Mouse Support

Enable/disable support for USB mouse.
Options: Enabled, Disabled.

► **Super IO Chip Setup**

Scroll to Super IO Chip Setup and press <Enter>. The following screen appears:

Phoenix - AwardBIOS CMOS Setup Utility		Item Help
SuperIO Device		Menu Level ▶▶
Onboard FDC Controller	[Enabled]	
Onboard Serial Port 1	[3F8/IRQ4]	
Onboard Serial Port 2	[2F8/IRQ3]	
UART Mode Select	[Normal]	
Onboard Parallel Port	[378/IRQ7]	
Parallel Port Mode	[SPP]	
EPP Mode Select	[EPP1.7]	
ECP Mode Use DMA	[3]	
Game Port Address	[201]	
Midi Port Address	[330]	
Midi Port IRQ	[10]	

Onboard FDC Controller

Select Enabled if your system has a floppy disk controller (FDC) installed on the system board and you wish to use it. If you install add-in FDC or the system has no floppy drive, select Disabled in this field.

Options: Enabled, Disabled.

BIOS

Onboard Serial Port 1/2

Select an address and corresponding interrupt for the first and second serial ports.

Options: 3F8/IRQ4, 2E8/IRQ3, 3E8/IRQ4, 2F8/IRQ3, Disabled, Auto.

UART Mode Select

This field is to configure which IR mode the 2nd serial port should use.

Options: Normal, IrDA and ASKIR.

Onboard Parallel Port

This field allows the user to configure the LPT port.

Options: 378/IRQ7, 278/IRQ5, 3BC/IRQ7, Disabled.

Parallel Port Mode

This field allows the user to select the parallel port mode.

Options: SPP, EPP, ECP, ECP+EPP, Normal.

EPP Mode Select

This item allows you to determine the IR transfer mode of onboard I/O chip. Options:

EPP1.9, EPP1.7.

ECP Mode USE DMA

This field allows the user to select DMA1 or DMA3 for the ECP mode.

Options: DMA1, DMA3.

Game Port Address

Select an address for the Game port.

Options: 201, 209, Disabled.

Midi Port Address

Select an address for the Midi port.

Options: 290, 300, 330, Disabled.

Midi Port IRQ

Select an interrupt for the Midi port.

Options: 5, 10.

4-5 Power Management Setup

Choose the “POWER MANAGEMENT SETUP” in the CMOS SETUP UTILITY to display the following screen. This menu allows the user to modify the power management parameters and IRQ signals. In general, these parameters should not be changed unless it’s absolutely necessary.

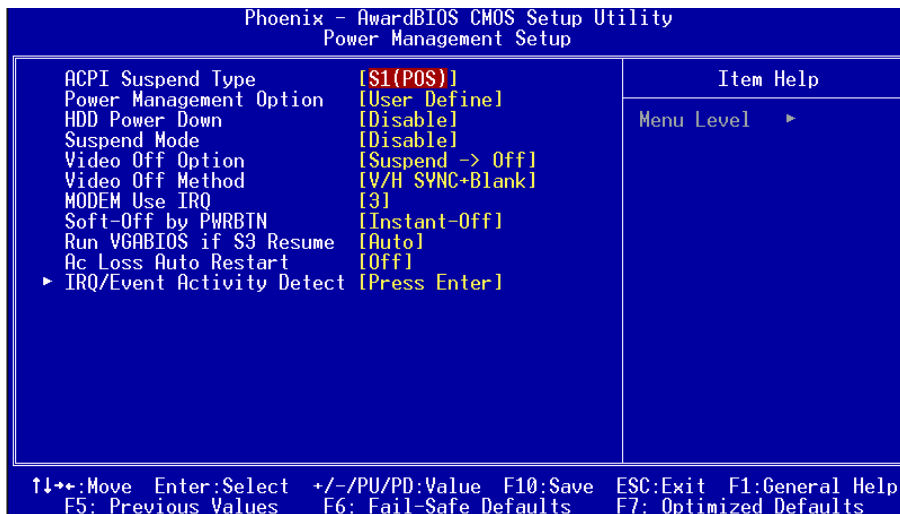

Figure 6: Power Management

ACPI Suspend Type

This item allows you to select S1(POS) or S3(STR) function.

Options: S1(POS), S3(STR), S1&S3.

Power Management Option

Use this to select your Power Management selection. The default is User define.

Max. saving: Maximum power savings. Inactivity period is 1 minute in each mode.

Min. saving: Minimum power savings. Inactivity period is 1 hour in each mode.

User define: Allows user to define PM Timers parameters to control power saving mode.

HDD Power Down

When enabled and after the set time of system inactivity, the hard disk drive will be powered down while all other devices remain active.

Options: Enabled, 1Min ~ 15Min.

BIOS

Suspend Mode

enabled and after the set time of system inactivity, all devices except the CPU will be shut off.

Options: Enabled, 1 , 2, 4 ,6, 8, 10, 20, 30, 40 min and 1 hour .

Video Off Option

When enabled, this feature allows the VGA adapter to operate in a power saving mode.

Always On: Monitor will remain on during power saving modes.

Suspend->Off: Monitor blanked when the systems enters the suspend mode.

Video Off Method

This option allows you to select how the video will be disabled by the power management. The default is V/H Sync + Blank

V/H Sync + Blank: System turns off vertical and horizontal synchronization ports and writes blanks to the video buffer.

DPMS Support: Select this option if your monitor supports the Display Power Management Signaling (DPMS) standard of the Video Electronics Standards Association (VESA). Use the software supplied for your video subsystem to select video power management values.

Blank Screen: System only writes blanks to the video buffer.

MODEM Use IRQ

Name the interrupt request (IRQ) line assigned to the modem (if any) on your system. Activity of the selected IRQ always awakens the system. Default is IRQ 3.

Options: N/A, 3, 4, 5, 7, 9, 10, 11

Soft-Off by PWRBTN

Pressing the power button for more than 4 seconds forces the system to enter the Soft-Off state when the system has “hung.” The default is Instant-off.

Options: Delay 4 Sec, Instant-Off.

Run VGABIOS if S3 Resume

This determines whether or not to enable the system to run the VGA BIOS when resuming from S3(STR) or S1&S3.

Options: Auto, Yes, No.

AC Loss Auto Restart

Configures the system to auto-restart or remain off after a power interrupt.

Off: System remains off after a power interrupt.

On: System always restarts after a power interrupt.

Auto: Depends on whether the system was safely shutdown during power failure.

► IRQ/Event Activity Detect

Scroll to IRQ/Event Activity Detect and press <Enter>. The following screen appears:

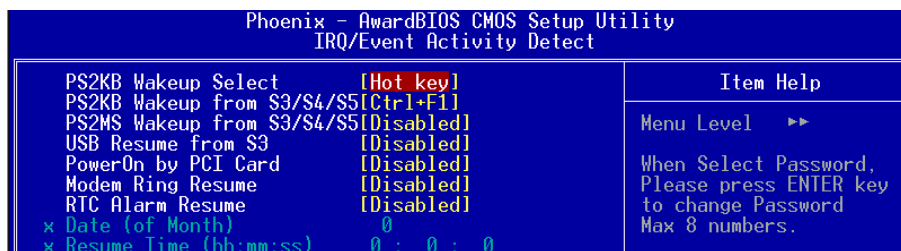

PS2KB Wakeup Select

This item allows you to select Hot Key or Password to wake-up the system by PS2 Keyboard. When select Password, please press ENTER key to change password max 8 numbers.

Options: Hot key, Password.

PS2KB Wakeup form S3/S4/S5

This item allows you to set a Hot Key to wake-up the system by PS2 Keyboard.

Options: Disabled, Ctrl+F1, Ctrl+F2, Ctrl+F3, Ctrl+F4, Ctrl+F5, Ctrl+F6, Ctrl+F7, Ctrl+F8, Ctrl+F9, Ctrl+F10, Ctrl+F11, Ctrl+F12, Power, Wake, Any key.

Note: Power and Wake are Windows98 Keyboard button.

PS2MS Wakeup form S3/S4/S5

This item allows you to wake-up the system by PS2 Mouse.

Options: Enabled, Disabled.

USB Resume from S3

This item allows you to wake-up the system by USB device when you save the computer power at S3.

Options: Enabled, Disabled.

BIOS

PowerOn by PCI Card

An input signal form PME on the PCI card awakens the system from a soft off state.

Options: Enabled, Disabled.

Modem Ring Resume

When set to *Enabled*, any event occurring to the Modem Ring will awaken a system which has been powered down.

Options: Enabled, Disabled.

RTC Alarm Resume

When set to *Enable rtc alarm resume*, you could set the date (of month) and timer (hh:mm:ss), any event occurring at will awaken a system which has been powered down.

4-6 PNP/PCI Configuration

The PNP/PCI configuration program is for the user to modify the PCI/ISA IRQ signals when various PCI/ISA cards are inserted in the PCI or ISA slots.

WARNING: Conflicting IRQ's may cause the system to not find certain devices.

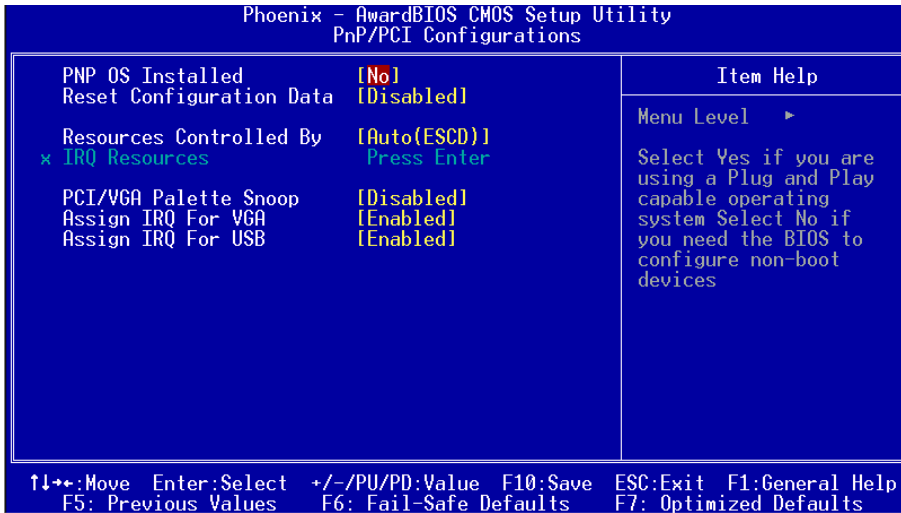

Figure 7: PNP/PCI Configuration Setup

PNP OS Installed

Select “Yes” if you have a PNP OS installed on your system. The default is No.

Options: Yes, No.

Reset Configuration Data

This setting allows you to clear ESCD data. The default is Disabled

Disabled: Normal Setting.

Enabled: If you have plugged in some Legacy cards to the system and they were recorded into ESCD (Extended System Configuration Data), you can set this field to Enabled in order to clear ESCD.

Resources Controlled By

Determines what controls system PNP/PCI resources. The default is Auto (ESCD).

Manual: PNP Card’s resources are controlled manually. The “IRQ Resources” field becomes available and you can set which IRQ-X and DMA-X are assigned to PCI/ISA PNP or Legacy ISA Cards.

BIOS

Auto: If your ISA card and PCI cards are all PNP cards, BIOS assigns the interrupt resource automatically.

PCI/VGA Palette Snoop

This item is designed to overcome problems that may be caused by some nonstandard VGA cards. This board includes a built-in VGA system that does not require palette snooping therefore you must leave this item disabled.

Options: Enabled, Disabled.

Assign IRQ For VGA

This item requests BIOS to assign an IRQ for the VGA. Selecting “Disabled” will free the IRQ for use by other devices.

Options: Enabled, Disabled.

Assign IRQ For USB

This item requests BIOS to assign an IRQ for the USB port. If you have not connected any USB device, selecting “Disabled” will free the IRQ for use by other devices.

Options: Enabled, Disabled.

Interrupt requests are shared as shown below:

	INT A	INT B	INT C	INT D
PCI 1	V			
PCI 2		V		
PCI 3			V	
PCI 4				V
PCI 5			V	
PCI 6				V
AGP Slot	V			
AC97			V	
Onboard USB1	V			
Onboard USB2	V			
Onboard USB3		V		
Onboard USB4		V		
USB2.0			V	
Onboard S-ATA (Optional)		V		
Onboard LAN (Optional)		V		
Onboard HPT372 (Optional)		V		
Onboard 1394 (Optional)			V	

IMPORTANT!

If using PCI cards on shared slots, make sure that the drivers support “Shared IRQ” or that the cards don’t need IRQ assignments. Conflicts will arise between the two PCI groups that will make the system unstable or cards inoperable.

4-7 PC Health Status

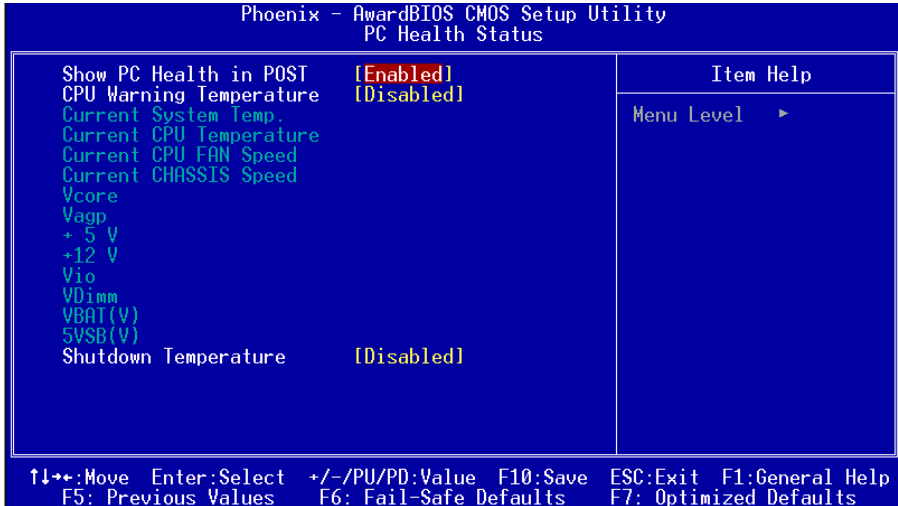

Figure 8: PC Health Status

Show PC Health in POST

When this function is enabled the PC Health information is displayed during the POST (Power On Self Test).

Options: Disabled, Enabled.

CPU Warning Temperature

Sets the temperature at which the computer will respond to an overheating CPU.

Options: Disabled, 50°C/122°F ~ 70°C/158°F.

Current System/CPU Temperature

Displays the current system/CPU temperature.

Current CPU/Chassis FAN Speed

Displays the current speed of the CPU and chassis fan speed in RPMs.

Vcore

The voltage level of the CPU(Vcore).

Vagp

The voltage level of Power supplied to AGP card.

BIOS

VDIMM

The voltage level of the DRAM.

VBAT(V)

The voltage level of the battery.

+ 5V, +12V, Vio, 5VSB(V)

The voltage level of the switching power supply.

Shutdown Temperature

This is the temperature that the computer will turn off the power to combat the effects of an overheating system. (requires ACPI to be enabled in Power Management BIOS and ACPI compliant operating system.) The default is Disabled.

Options available are 60°C/140°F to 75°C/167°F in increments of 5°C.

4-8 Power BIOS Features

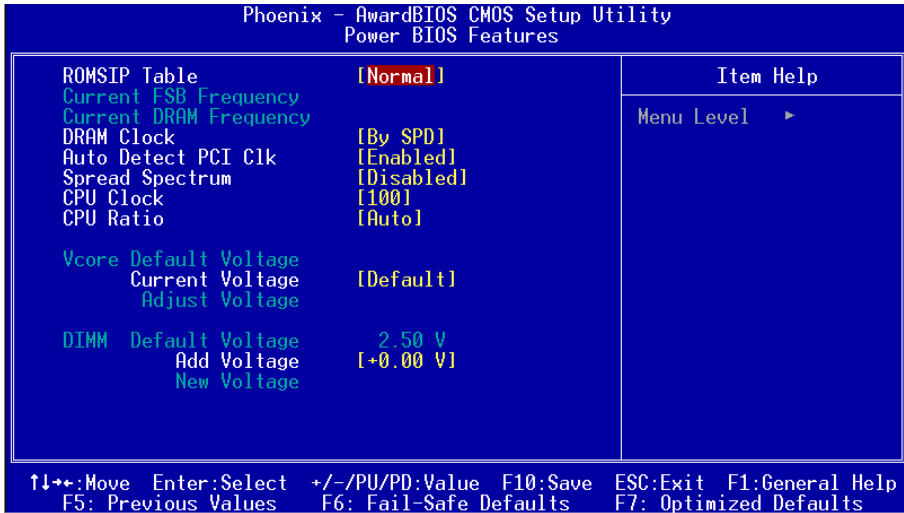

Figure 9: Frequency/Voltage Control

ROMSIP Table

This item can enhance performance.

Options: Normal, Fast, Ultra.

Current FSB Frequency

Display the current CPU front side bus frequency information.

Current DRAM Frequency

Display the current DRAM frequency information.

DRAM Clock

This item allows you to select DRAM clock.

Options: By SPD, 100MHz, 133MHz, 166MHz, 200MHz.

Auto Detect PCI Clk

When enabled the mainboard automatically disables the clock source for a PCI slot which does not have a module in it, reducing EMI (ElectroMagnetic Interference).

Options: Enabled, Disabled.

Spread Spectrum

If you enable spread spectrum, it can significantly reduce the EMI (ElectroMagnetic Interference) generated by the system.

Options: Disabled, Enabled.

CPU Clock

Enables you to set the CPU front side bus speed at increments of 1MHz step. The default is 100 MHz. Press <Enter> to display the following screen:

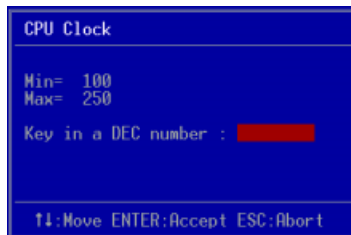

Key in the DEC (decimalism) number for the CPU clock.

Note: Overclocking failure will cause no display on monitor. At this moment, please press “Insert” key to revert back to the initial or default setting to boot up your system.

BIOS

CPU Vcore Voltage

This item allows you to set the CPU Vcore voltage.

Options: Default, 1.400V to 1.850V in 0.025V increment and 1.850V to 2.000V in 0.050V increment. We recommend that you leave this at the default value.

DIMM Voltage

This item allows you to adjust the DIMM slot voltage.

Options: +0.00V to +0.70V in 0.10V increments. We recommend that you leave this at the default value.

4-9 Defaults Menu

Selecting “Defaults” from the main menu shows you two options which are described below

Load Fail-Safe Defaults

When you press <Enter> on this item you get a confirmation dialog box:

Load Fail-Safe Defaults (Y/N) ? N

Pressing ‘Y’ loads the BIOS default values for the most stable, minimal-performance system operations.

Load Optimized Defaults

When you press <Enter> on this item you get a confirmation dialog box:

Load Optimized Defaults (Y/N) ? N

Pressing ‘Y’ loads the default values that are factory settings for optimal performance system operations.

4-10 Supervisor/User Password Setting

You can set either supervisor or user password, or both of them. The differences between are:

supervisor password : can enter and change the options of the setup menus.

user password : just can only enter but do not have the right to change the options of the setup menus. When you select this function, the following message will appear at the center of the screen to assist you in creating a password.

ENTER PASSWORD:

Type the password, up to eight characters in length, and press <Enter>. The password typed now will clear any previously entered password from CMOS memory. You will be asked to confirm the password. Type the password again and press <Enter>. You may also press <Esc> to abort the selection and not enter a password.

To disable a password, just press <Enter> when you are prompted to enter the password. A message will confirm the password will be disabled. Once the password is disabled, the system will boot and you can enter Setup freely.

PASSWORD DISABLED.

When a password has been enabled, you will be prompted to enter it every time you try to enter Setup. This prevents an unauthorized person from changing any part of your system configuration.

Additionally, when a password is enabled, you can also require the BIOS to request a password every time your system is rebooted. This would prevent unauthorized use of your computer.

You determine when the password is required within the BIOS Features Setup Menu and its Security option. If the Security option is set to "System", the password will be required both at boot and at entry to Setup. If set to "Setup", prompting only occurs when trying to enter Setup.

BIOS

4-11 Exiting BIOS

Save & Exit Setup

Pressing <Enter> on this item asks for confirmation:

Save to CMOS and EXIT (Y/N)? Y

Pressing “Y” stores the selections made in the menus in CMOS – a special section of memory that stays on after you turn your system off. The next time you boot your computer, the BIOS configures your system according to the Setup selections stored in CMOS. After saving the values the system is restarted again.

Exit Without Saving

Pressing <Enter> on this item asks for confirmation:

Quit without saving (Y/N)? Y

This allows you to exit Setup without storing in CMOS any change. The previous selections remain in effect. This exits the Setup utility and restarts your computer.

Section 5 Driver Installation

Easy Driver Installation

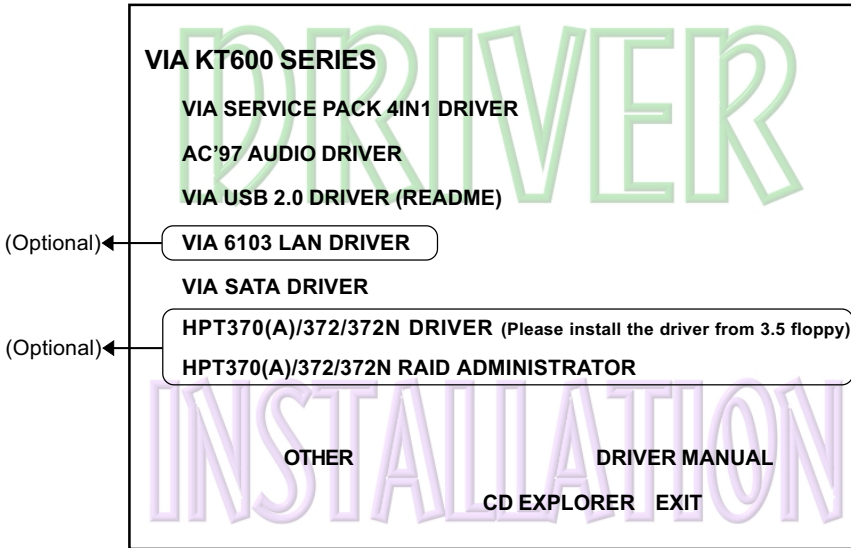

Insert the bundled CD-disk, the main menu screen will appear. The main menu displays buttons that link you to the supported drivers, utilities and software.

- Step 1 :** Click **“SERVICE PACK 4IN1 DRIVER”** to install all components recommended.
- Step 2 :** Click **“AC'97 AUDIO DRIVER”** to install audio driver.
- Step 3:** Click **“VIA USB V2.0 DRIVER”** to install USB2.0 driver under Windows XP system , for Windows 9x/ME operation system refer to README.HTM file introduction to install USB V2.0 driver.
- Step 4 :** Click **“VIA 6103 LAN DRIVER”** to install LAN driver. (Optional)
- Step 5 :** Click **“VIA SATA RAID DRIVER”** to install Serial ATA driver.
- Step 6 :** If your board equipped with a HPT370(A)/372/372N device, please install the driver from 3.5 floppy. (Optional)
The **“HPT370(A)/372/372N RAID ADMINISTRATOR”** item is for install Raid Administrator. (Optional)

Drivers Installation

Realtek Sound Manager Quick User-guide

◆ Introduction

To obtain the best performance from your audio system, run the "Sound Manager" utility to adjust the settings to suit your needs. This section of the manual is intended to provide a quick user-guide to setup "Sound Manager". For more detailed information, refer to "Sound Manager manual" in the CD.

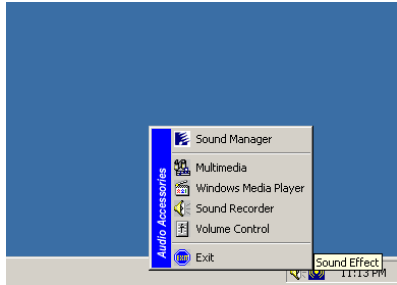

<Figure 1>

1. Right-click "Sound Effect" button on the task bar and select "Sound Manager".

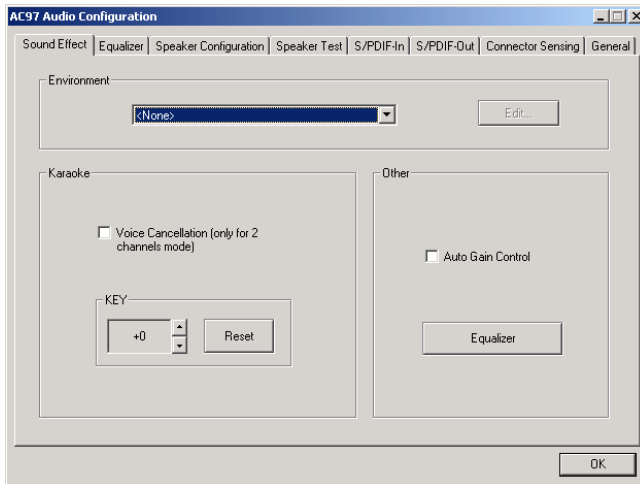

Sound Effect:

<Figure 2>

2. Select "Sound Effect" page to set the desired audio environment from the pull-down menu. There are in total 23 kinds of sound effect.
 - a. For Karaoke function, "Voice Cancellation (only for 2 channels mode)" removes the human voice. "Key" lets you adjust the key pitch.
 - b. "Auto Gain Control" avoids saturation when adjusting the equalizer.

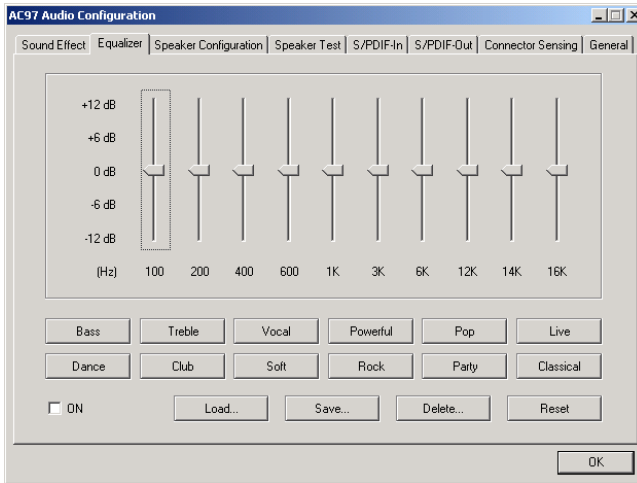

Equalizer:

<Figure 3>

3. There are 10 bands of equalizer control, check "ON" when you want to adjust the equalizer.

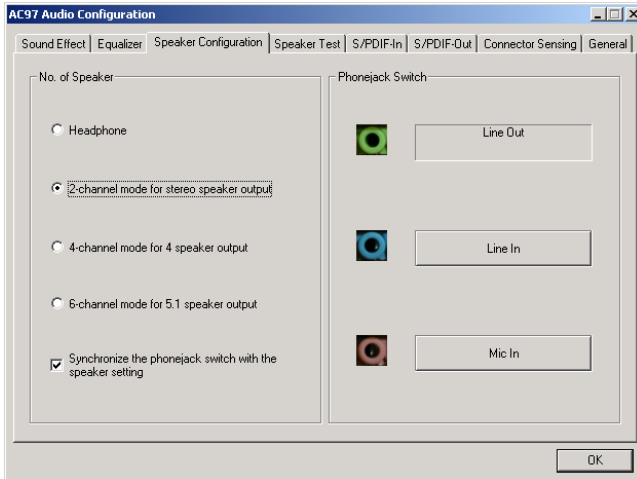

Speaker Configuration:

<Figure 4>

4. This page displays the mainboards's phone jack function when a corresponding audio mode (no. of speaker) is selected.

Figure 4 above shows the phone jack setup for 2 channel mode.

Drivers Installation

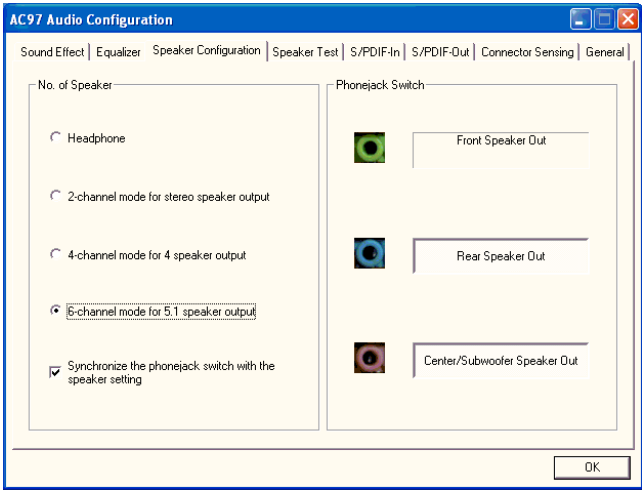

Speaker Configuration:

<Figure 5>

5. For 6 channel mode, the audio combination is shown above.

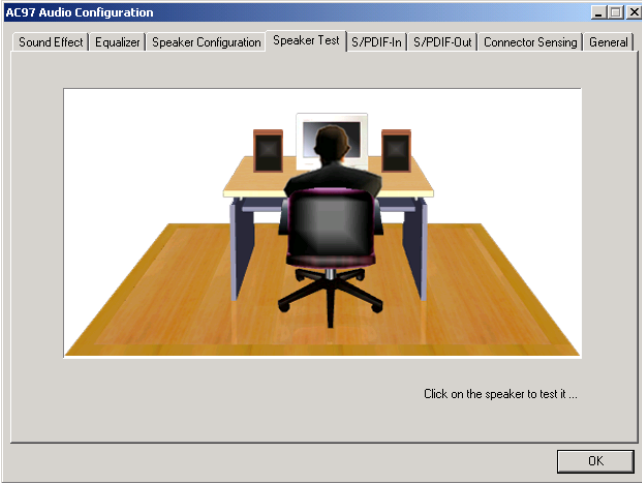

Speaker Test:

<Figure 6>

6. To test the speaker , select the “**Speaker Test**” page and click directly on the speakers shown on the screen.

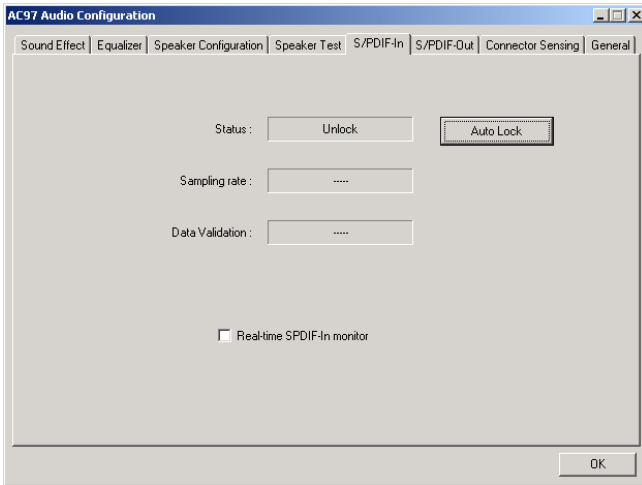

SPDIF-In:

<Figure 7>

7. This page shows S/PDIF IN function on your system.
 - a. Click "Auto Lock" to detect S/PDIF input and display its information.
 - b. Check "Real-time S/PDIF-In monitor" to listen to the S/PDIF IN signal through Line-out connector.

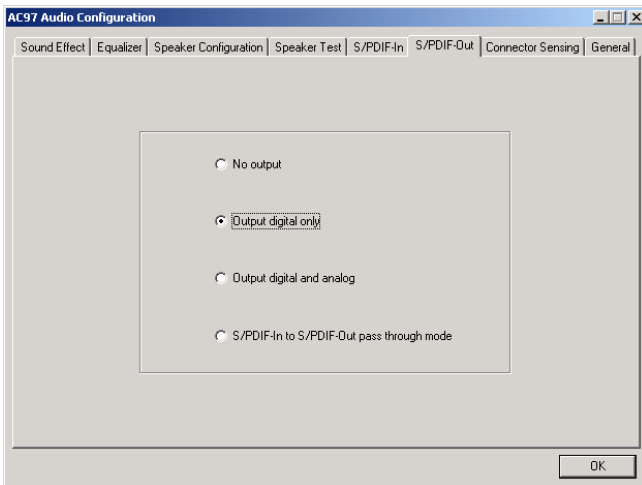

SPDIF-Out:

<Figure 8>

8. This page lets you choose the type of audio source that will appear on the S/PDIF-out connector.

Drivers Installation

This board is equipped with Jack Sensing capability. If an audio device is plugged into the wrong connector, a warning message will appear to remind users to check the connection.

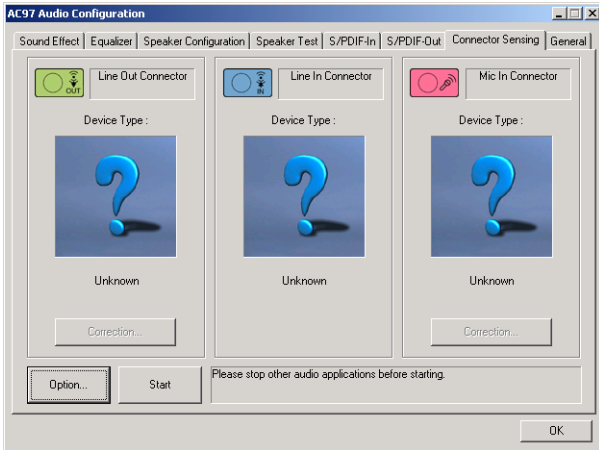

Connector Sensing:

<Figure 9>

9. Push "Start" button to start the sensing. Please remember to terminate all audio applications before starting the sensing.

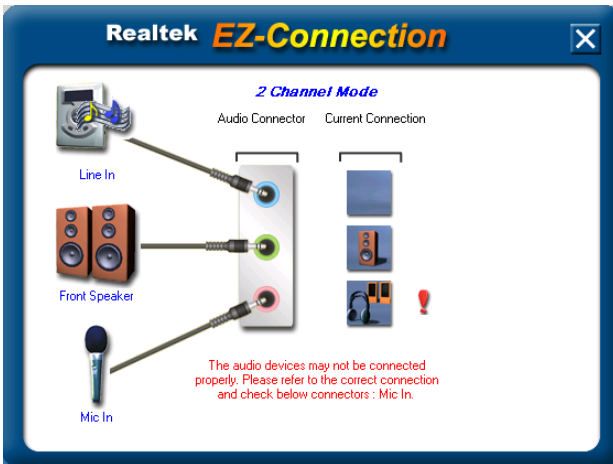

Connector Sensing:

<Figure 10>

10. EZ-Connection shows the result of the detection.
“Audio Connector” column reflects the settings used in the "Speaker Configuration" page.
“Current Connection” column shows the type of device detected. If the results do not match, an exclamation mark will appear on the right side.

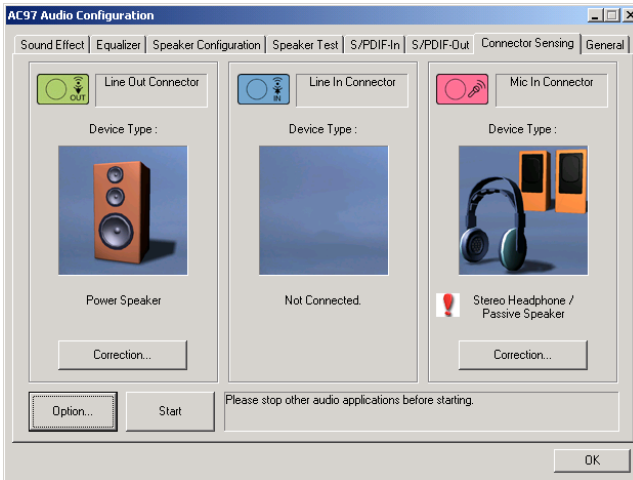

Connector Sensing:

<Figure 11>

11. After closing EZ-Connector, this page will show the latest connector status as above.

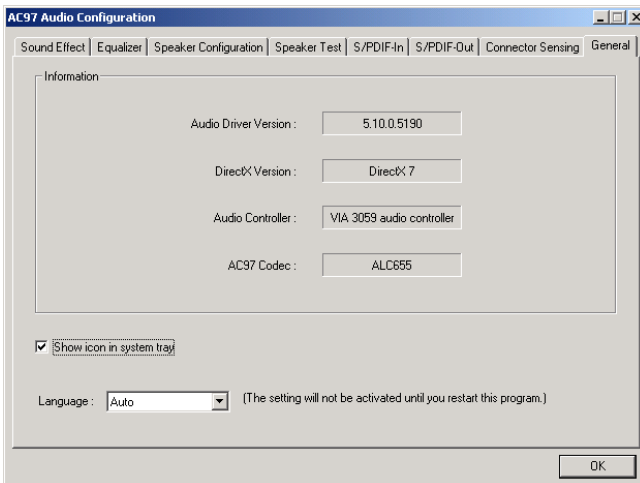

General:

<Figure 12>

12. This page displays information regarding the audio hardware and software. To remove "Sound Manager" icon from Windows Task bar, uncheck "Show icon in system tray".

A-1 Realtek Media Player User's Guide

Realtek Media Player Platform

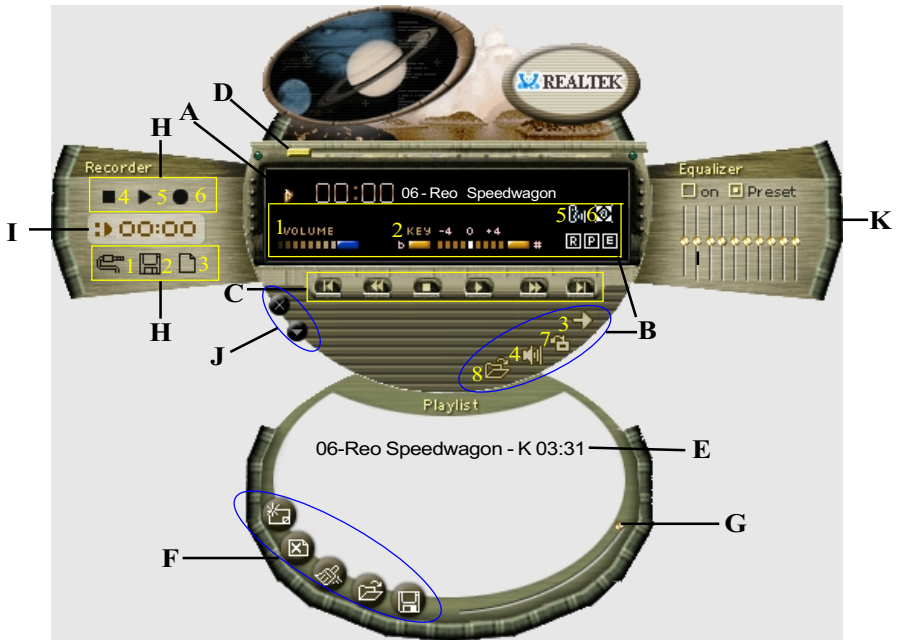

Functional Descriptions

A. Playback Windows Display

Playback windows displays the following mode information:

1. Playback Time Display
2. Voice Cancellation Mode Display
3. Pitch Mode Display
4. Surround Sound Mode Display

Appendix

B. Playback Function Controls

There are 8 selectable functions for the playback:

1. Volume control High/Low Adjustment Bar.
2. Pitch control 4-step High/Low Adjustment Bar.
3. Repeat mode Choice of Repeat, All Repeat, Random or No Repeat Mode.
4. Mute Mute On/Off Mode select.
5. Voice cancellation Voice Cancellation On/Off Mode select for Karaoke.
6. Surround mode A total of 26 Surround Sound mode select as shown in the table below.

Surround mode	Surround mode
Generic	Stone corridor
Padded	Alley
Room	Forrest
Bathroom	City
Living room	Mountain
Stone	Quarry
Auditorium	Plain
Concert	Parking lot
Cave	Sewer pipe
Arena	Under water
Hangar	Drug
Carpet	Dizzy
Hallway	Psychological

7. Skin change Media Player Skin Type select.
8. Open Open file formats including MP3, CDA, MDI, WAV & WMA support.

C. Playback Controls

The playback controls include “Play”, “Pause”, “Stop”, “Previous”, “Backward”, “Forward”, & “Next”.

D. Seeking bar

Display Animated Playback Status

E. Title/Play List Windows

Display Currently Selected Title(s)

F. Title/Play List Edit Controls

There title/play list controls include “Add”, “Del”, “Clear”, “Load”, & “Store”.

1. Add Add to the Title/Play List.
2. Del Remove form the Title/Play List.
3. Clear Clear the Title/Play List.
4. Load Load Title/Play List.
5. Store Save Title/Play List.

G. Title/Play List Scroll bar

Scroll Up/Down the Title/Play List.

H. Recording Function Controls

The recording function controls include “Input”, “Save”, “New”, “Rec”, “Stop”, & “Play”.

1. Input Input soruce select.
2. Save Save to file.
3. New Open new file & select format includes Sampling Rate, Sampling bit, Mono or Stereo.
4. Rec Start Rec.
5. Stop Stop Rec.
6. Play Playback Rec file.

I. REC/Playback Time Display

Displays REC/Playback Time.

Appendix

J. Platform Display Panel Controls

The platform display panel control include “Minimize” & “Close”.

1. Minimize Minimize Platform Display Panel.
2. Close Close/Exit Platform Display Panel.

K. Equalizer Control Panel

The Equalizer Control Panel include “On/Off” & “Preset”.

1. On/Off Enable/Disable Equalizer.
2. Preset Clear Equalizer setting to default value.

B-1 Update Your System BIOS

Download the xxxxx.EXE file corresponding to your model from our website to an empty directory on your hard disk or floppy. Run the downloaded xxxxx.EXE file and it will self extract. Copy these extracted files to a bootable DOS floppy disk.

Note: The DOS floppy disk should contain NO device drivers or other programs.

1. Type "A:\AWDFLASH and press <Enter> Key.
2. You will see the following setup screen.
3. Please key in the xxxxx.bin BIOS file name.

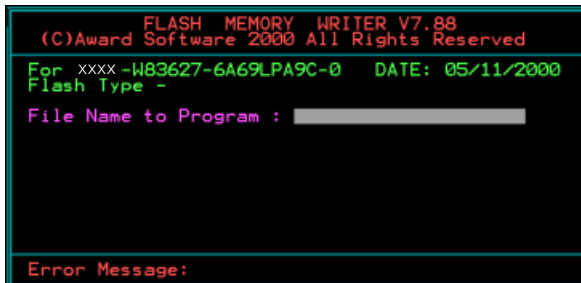

```
FLASH MEMORY WRITER V7.88
(C)Award Software 2000 All Rights Reserved

For xxxx-W83627-6A69LPA9C-0  DATE: 05/11/2000
Flash Type -
File Name to Program : _____

Error Message:
```

4. If you want to save the previous BIOS data to the diskette, please key in [Y], otherwise please key in [N].

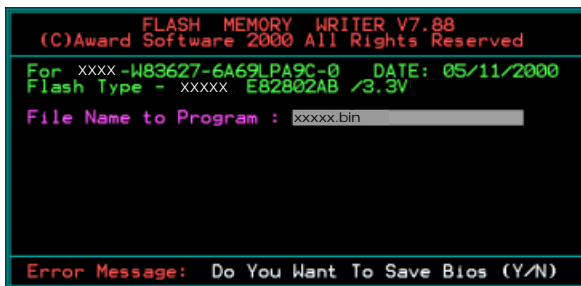

```
FLASH MEMORY WRITER V7.88
(C)Award Software 2000 All Rights Reserved

For xxxx-W83627-6A69LPA9C-0  DATE: 05/11/2000
Flash Type - xxxxx E82802AB /3.3V
File Name to Program : xxxxx.bin

Error Message: Do You Want To Save Bios (Y/N)
```

Appendix

5. Key in File Name to save previous BIOS to file.

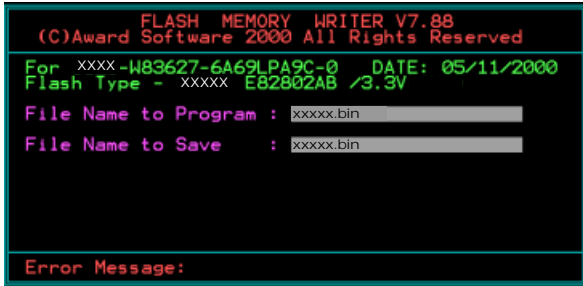

6. To confirm and proceed, please key in [Y] to start the programming.

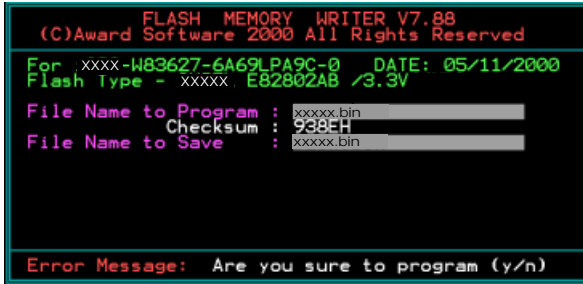

7. The BIOS update is finished.

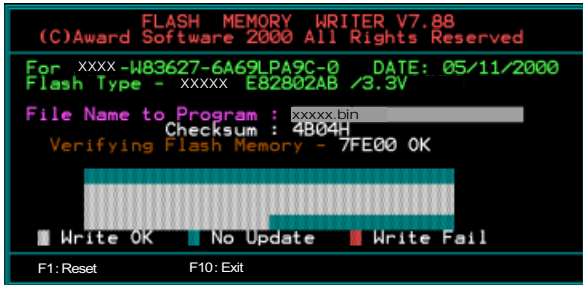

C-1 EEPROM BIOS Remover

Do not remove the BIOS chip, unless instructed by a technician and only with a PLCC IC extractor tool.

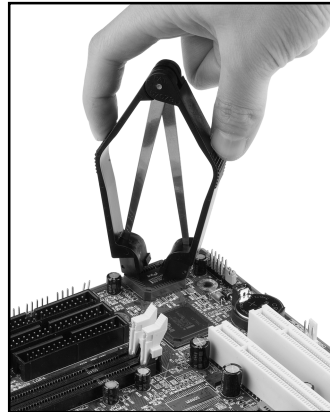
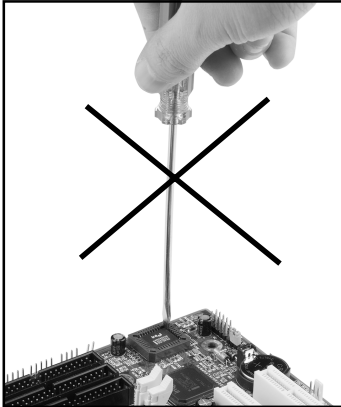

The BIOS socket is fragile may be damaged if an improper method to replace the BIOS chip is applied.

Appendix D

D-1 GHOST 7 Quick User's Guide (Optional)

Installation is very easy. You only need to copy the **Ghost7** folder or **Ghost.exe** to your hard disk.

Main Menu

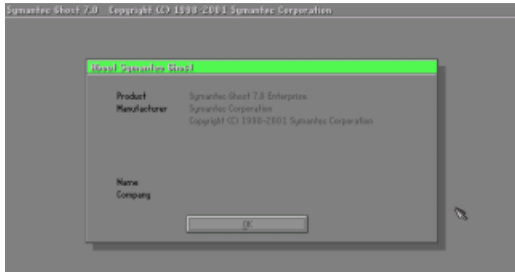

Description of Menu

Ghost clones and backs up **Disk** and **Partition**.

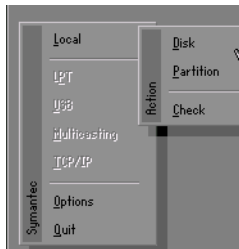

In which **Disk** indicates hard disk options
Partition indicates partition options
Check indicates check options

Disk

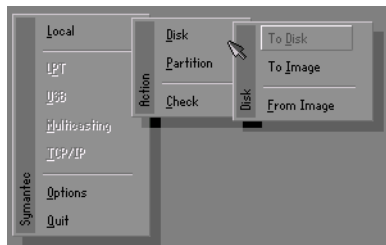

Appendix

There are 3 hard disk functions:

1. Disk To Disk (disk cloning)
2. Disk To Image (disk backup)
3. Disk From Image (restore backup)

Important!

1. To use this function, the system must have at least 2 disks. Press the **Tab** key to move the cursor.
2. When restoring to a destination disk, all data in that disk will be completely destroyed.

Disk To Disk (Disk Cloning)

1. Select the location of the **Source drive**.
2. Select the location of the **Destination drive**.

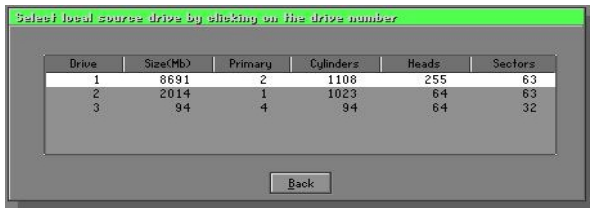

3. When cloning a disk or restoring the backup, set the required partition size as shown in the following figure.



4. Click OK to display the following confirmation screen. Select **Yes** to start.

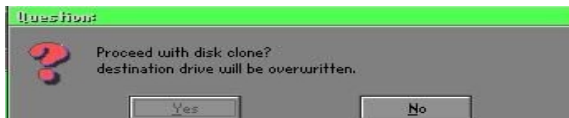

Disk To Image (Disk Backup)

1. Select the location of the Source drive.

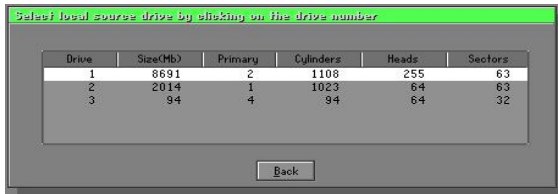

2. Select the location for storing the backup file.

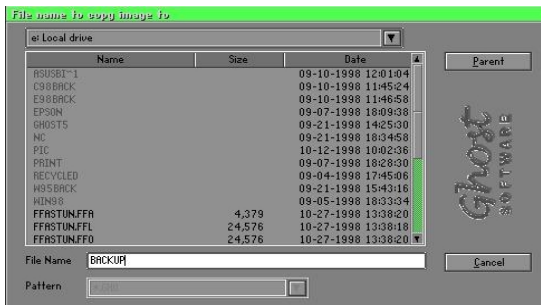

3. Click **OK** to display the following confirmation screen. Select **Yes** to start.

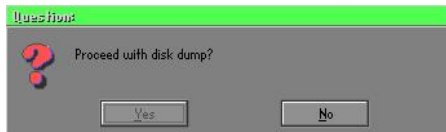

Disk From Image (Restore Backup)

1. Select the Restoring file.

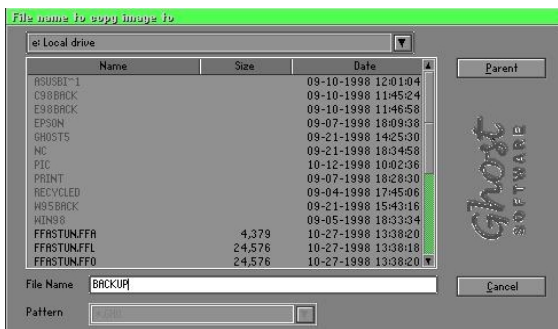

Appendix

2. Select the **Destination drive** of the disk to be restored.

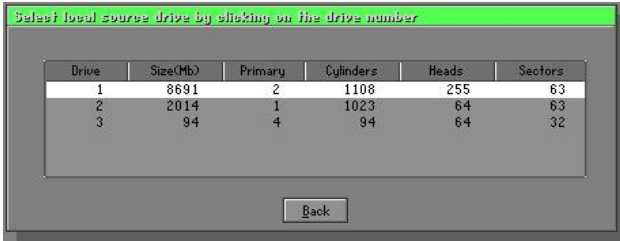

3. When restoring disk backup, set the required partition size as shown in the following figure.

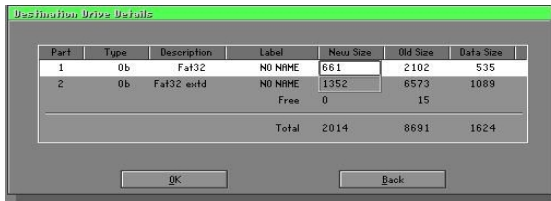

4. Click **OK** to display the following confirmation screen. Select **Yes** to start.

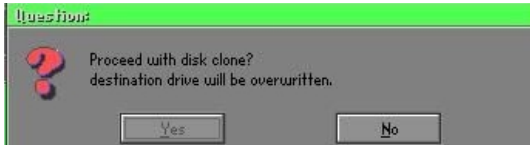

Partition

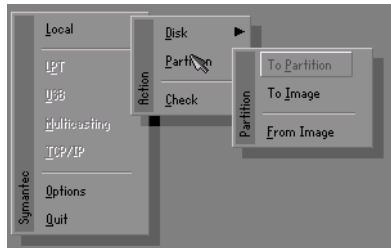

There are 3 partition functions:

1. **Partition To Partition** (partition cloning)
2. **Partition To Image** (partition backup)
3. **Partition From Image** (restore partition)

Partition To Partition (Partition Cloning)

The basic unit for partition cloning is a “partition”. Refer to “disk cloning” for the operating method.

Partition To Image (Partition Backup)

1. Select the disk to be backed up.

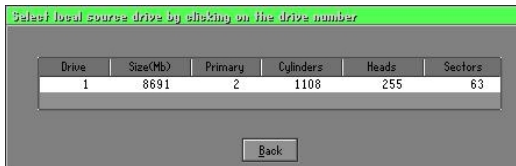

2. Select the first partition to be backed up. This is usually where the operating system and programs are stored.

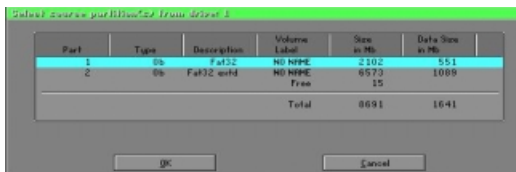

3. Select the path and file name to store the backup file.

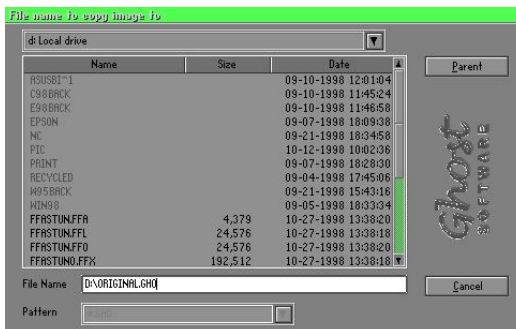

Appendix

- Is the file compressed? There are 3 options:
 - No: do not compress data during backup
 - Fast: Small volume compression
 - High: high ratio compression. File can be compressed to its minimum, but requiring longer execution time.

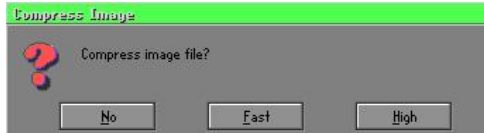

- Select Yes to start performing backup.



Partition From Image (Restore Partition)

- Select the backup file to be restored.

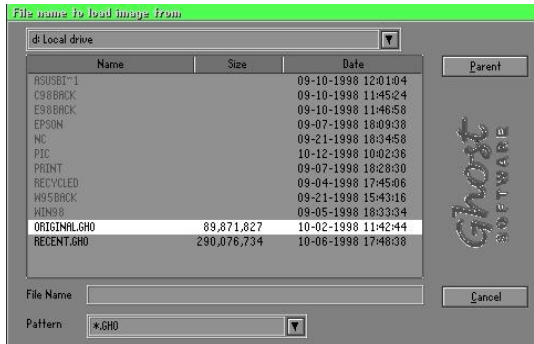

- Select the source partition.

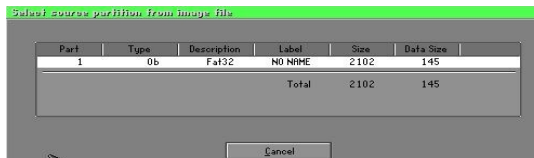

3. Select the disk to be restored.



4. Select the partition to be restored.



5. Select Yes to start restoring.

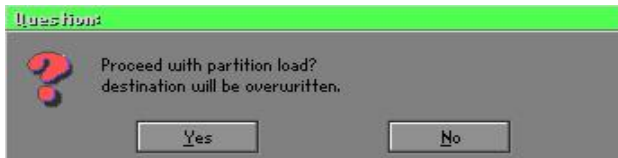

Check

This function is to check possible error caused by defective FAT or track during backup or restoring.

How to Reinstall Windows in 2 Minutes

This chapter guides you how to setup your computer properly and, if necessary, reinstall Windows in 2 minutes. **Ghost** provides different methods to complete this task. The following two sections explain how to create an emergency **Recover Floppy** and **Recover CD**:

Emergency Recover Floppy

Divide a hard disk into two partitions. The first partition is to store the operating system and application programs. The second partition is to back up the operating system and data. The size of the partition can be determined according to the backup requirements. For example, the **Windows** operating system needs 200MB of hard disk space, Plus complete **Office** programs require 360MB. The remaining space can be used to store data.

After installing **Windows**, use **Ghost** to create a backup area for the system and to store the file (Image file) in drive D. The file is named **Original.gho**. Then, create a recover floppy disk containing:

- ◆ Bootable files (Command.com, Io.sys, and MSDOS.SYS)
- ◆ Config.sys (configuration setup file)
- ◆ Autoexec.bat (auto-execution batch file)
- ◆ Ghost.exe (Ghost execution file)

There are two ways to create the content of the recover floppy for restoring:

- (1) To load **Windows** automatically after booting, store the **Autoexec.bat** file with a command line:

```
Ghost.exe clone, mode=pload, src=d:\original.gho:2,dst=1:1 -fx -sure -rb
```

Command Description: Runs the restore function automatically with the Image File. Stored in drive D. After execution, it will exit Ghost and boots the system.

Refer to the [Introducing Ghosts Functions] for details.

- (2) After booting, the screen displays the Menu. Select Backup or Restore: Since the user may install other applications in the future, he/she may alter **Autoexec.bat** file to back up or restore the user-defined Image file as follows:

Backup

Back up Windows and application programs as a file (Recent.gho). Command is:

```
Ghost -clone,mode=pdump,src=1:1,dst=d:\Recent.gho -fx -  
sure -rb
```

Restore

Restore types include [**General Windows**] and [**Windows and Application Programs**]. If you select [**General Windows**], the system is restored to the general **Windows** operation condition. The command is:

```
Ghost.exe -clone,mode=pload,src=d:\Original.gho,dst=1:1 -fx  
-sure -rb
```

If you select [**Windows and Application Programs**], the latest backup file (Recent.gho) is restored, skipping the installation and setup of application programs.

For description of related parameters, refer to [**Introducing Ghosts Functions**].

For more information about menu design, refer to Config.sys and Autoexec.bat under /Menu in the CD. You can also create a backup CD containing Ghost.exe and these two files.

Recover CD

The following is a simple guide to create a recover CD:

1. First, create a recover floppy disk contains the following with any copy program such as “Easy CD Create” (Note 2) :

Bootable files (Command.com and Io.sys and MSDOS.SYS)

Config.sys (Configuration setup file)

Autoexec.bat (Auto-execution batch file)

Mscdex.exe (CD-Rom execution file)

Ghost.exe (Ghost execution file)

Oakcdrom.sys (ATAPI CD-ROM compatible driver)

The content of Config.sys is:

```
DEVICE=Oakcdrom.sys /d:idecd001
```

The content of Autoexec.bat includes:

```
MSCDEX.EXE /D:IDECD001 /L:Z
```

```
Ghost.exe clone,mode=load,src=z:\original.gho,dst=1 -sure -rb
```

2. Write the backup image file (original.gho) of the entire hard disk or partition into the recover CD. Use the Recover CD to boot up the system and restore the backup files automatically.

For description of related parameters, refer to **[Introducing Ghosts Functions]**.

Note: For more details about copy the creation program and method to create a recover CD, please refer to the related software and its associated operating manual.

Note: Ghost may be executed in interactive or in batch mode. Most of the Ghost switches are used to assist in batch mode operation. To list switches, type ghost.exe -h.

E-1 POST CODES

POST (hex)	DESCRIPTION
CFh	Test CMOS R/W functionality.
C0h	Early chipset initialization: <ul style="list-style-type: none"> - Disable shadow RAM - Disable L2 cache (socket 7 or below) - Program basic chipset registers
C1h	Detect memory <ul style="list-style-type: none"> - Auto-detection of DRAM size, type and ECC. - Auto-detection of L2 cache (socket 7 or below)
C3h	Expand compressed BIOS code to DRAM
C5h	Call chipset hook to copy BIOS back to E000 & F000 shadow RAM.
01h	Expand the Xgroup codes locating in physical address 1000:0
02h	Reserved
03h	Initial Superio_Early_Init switch.
04h	Reserved
05h	<ol style="list-style-type: none"> 1. Blank out screen 2. Clear CMOS error flag
06h	Reserved
07h	<ol style="list-style-type: none"> 1. Clear 8042 interface 2. Initialize 8042 self-test
08h	<ol style="list-style-type: none"> 1. Test special keyboard controller for Winbond 977 series Super I/O chips. 2. Enable keyboard interface.
09h	Reserved
0Ah	<ol style="list-style-type: none"> 1. Disable PS/2 mouse interface (optional). 2. Auto detect ports for keyboard & mouse followed by a port & interface swap (optional). 3. Reset keyboard for Winbond 977 series Super I/O chips.
0B-0Dh	Reserved
0Eh	Test F000h segment shadow to see whether it is R/W-able or not. If test fails, keep beeping the speaker.
0Fh	Reserved
10h	Auto detect flash type to load appropriate flash R/W codes into the run time area in F000 for ESCD & DMI support.
11h	Reserved
12h	Use walking 1's algorithm to check out interface in CMOS circuitry. Also set real-time clock power status, and then check for override.
13h	Reserved
14h	Program chipset default values into chipset. Chipset default values are MODBINable by OEM customers.
15h	Reserved
16h	Initial Early_Init_Onboard_Generator switch.
17h	Reserved

Appendix

18h	Detect CPU information including brand, SMI type (Cyrix or Intel) and CPU level (586 or 686).
19-1Ah	Reserved
1Bh	Initial interrupts vector table. If no special specified, all H/W interrupts are directed to SPURIOUS_INT_HDLR & S/W interrupts to SPURIOUS_soft_HDLR.
1Ch	Reserved
1Dh	Initial EARLY_PM_INIT switch.
1Eh	Reserved
1Fh	Load keyboard matrix (notebook platform)
20h	Reserved
21h	HPM initialization (notebook platform)
22h	Reserved
23h	<ol style="list-style-type: none">1. Check validity of RTC value: e.g. a value of 5Ah is an invalid value for RTC minute.2. Load CMOS settings into BIOS stack. If CMOS checksum fails, use default value instead.3. Prepare BIOS resource map for PCI & PnP use. If ESCD is valid, take into consideration of the ESCD's legacy information.4. Onboard clock generator initialization. Disable respective clock resource to empty PCI & DIMM slots.5. Early PCI initialization: -Enumerate PCI bus number -Assign memory & I/O resource -Search for a valid VGA device & VGA BIOS, and put it into C000:0.
24-26h	Reserved
27h	Initialize INT 09 buffer
28h	Reserved
29h	<ol style="list-style-type: none">1. Program CPU internal MTRR (P6 & PII) for 0-640K memory address.2. Initialize the APIC for Pentium class CPU.3. Program early chipset according to CMOS setup. Example: onboard IDE controller.4. Measure CPU speed.5. Invoke video BIOS.
2A-2Ch	Reserved
2Dh	<ol style="list-style-type: none">1. Initialize multi-language2. Put information on screen display, including Award title, CPU type, CPU speed
2E-32h	Reserved
33h	Reset keyboard except Winbond 977 series Super I/O chips.
34-3Bh	Reserved
3Ch	Test 8254
3Dh	Reserved
3Eh	Test 8259 interrupt mask bits for channel 1.
3Fh	Reserved
40h	Test 8259 interrupt mask bits for channel 2.
41h	Reserved
42h	Reserved

43h	Test 8259 functionality.
44h	Reserved
45-46h	Reserved
47h	Initialize EISA slot
48h	Reserved
49h	<ol style="list-style-type: none">1. Calculate total memory by testing the last double word of each 64K page.2. Program writes allocation for AMD K5 CPU.
4A-4Dh	Reserved
4Eh	<ol style="list-style-type: none">1. Program MTRR of M1 CPU2. Initialize L2 cache for P6 class CPU & program CPU with proper cacheable range.3. Initialize the APIC for P6 class CPU.4. On MP platform, adjust the cacheable range to smaller one in case the cacheable ranges between each CPU are not identical.
4Fh	Reserved
50h	Initialize USB
51h	Reserved
52h	Test all memory (clear all extended memory to 0)
53-54h	Reserved
55h	Display number of processors (multi-processor platform)
56h	Reserved
57h	<ol style="list-style-type: none">1. Display PnP logo2. Early ISA PnP initialization -Assign CSN to every ISA PnP device.
58h	Reserved
59h	Initialize the combined Trend Anti-Virus code.
5Ah	Reserved
5Bh	(Optional Feature) Show message for entering AWDFLASH.EXE from FDD (optional)
5Ch	Reserved
5Dh	<ol style="list-style-type: none">1. Initialize Init_Onboard_Super_IO switch.2. Initialize Init_Onboard_AUDIO switch.
5E-5Fh	Reserved
60h	Okay to enter Setup utility; i.e. not until this POST stage can users enter the CMOS setup utility.
61-64h	Reserved
65h	Initialize PS/2 Mouse
66h	Reserved
67h	Prepare memory size information for function call: INT 15h ax=E820h
68h	Reserved
69h	Turn on L2 cache
6Ah	Reserved
6Bh	Program chipset registers according to items described in Setup & Auto-configuration table.
6Ch	Reserved
6Dh	<ol style="list-style-type: none">1. Assign resources to all ISA PnP devices.2. Auto assign ports to onboard COM ports if the corresponding item in Setup is set to "AUTO".

Appendix

6Eh	Reserved
6Fh	<ol style="list-style-type: none">1. Initialize floppy controller2. Set up floppy related fields in 40:hardware.
70-72h	Reserved
73h	(Optional Feature) Enter AWDFLASH.EXE if : -AWDFLASH is found in floppy drive. -ALT+F2 is pressed
74h	Reserved
75h	Detect & install all IDE devices: HDD, LS120, ZIP, CDROM.....
76h	Reserved
77h	Detect serial ports & parallel ports.
78h-79h	Reserved
7Ah	Detect & install co-processor
7B-7Eh	Reserved
7Fh	<ol style="list-style-type: none">1. Switch back to text mode if full screen logo is supported. -If errors occur, report errors & wait for keys -If no errors occur or F1 key is pressed to continue:<ul style="list-style-type: none">• Clear EPA or customization logo.
80h-81h	Reserved
82h	<ol style="list-style-type: none">1. Call chipset power management hook.2. Recover the text font used by EPA logo (not for full screen logo)3. If password is set, ask for password.
83h	Save all data in stack back to CMOS
84h	Initialize ISA PnP boot devices
85h	<ol style="list-style-type: none">1. USB final Initialization2. NET PC: Build SYSID structure3. Switch screen back to text mode4. Set up ACPI table at top of memory.5. Invoke ISA adapter ROMs6. Assign IRQs to PCI devices7. Initialize APM8. Clear noise of IRQs.
86-92h	Reserved
93h	Read HDD boot sector information for Trend Anti-Virus code
94h	<ol style="list-style-type: none">1. Enable L2 cache2. Program boot up speed3. Chipset final initialization.4. Power management final initialization5. Clear screen & display summary table6. Program K6 write allocation7. Program P6 class write combining
95h	<ol style="list-style-type: none">1. Program daylight saving2. Update keyboard LED & typematic rate
96h	<ol style="list-style-type: none">1. Build MP table2. Build & update ESCD3. Set CMOS century to 20h or 19h4. Load CMOS time into DOS timer tick5. Build MSIRQ routing table.
FFh	Boot attempt (INT 19h)